

H8/3664 E6000 Emulator

User's Manual

Renesas Microcomputer Development Environment System
H8 Family / H8/300H Tiny Series
HS3664EPI62HE-U2

User's Manual

Notes regarding these materials

1. This document is provided for reference purposes only so that Renesas customers may select the appropriate Renesas products for their use. Renesas neither makes warranties or representations with respect to the accuracy or completeness of the information contained in this document nor grants any license to any intellectual property rights or any other rights of Renesas or any third party with respect to the information in this document.
2. Renesas shall have no liability for damages or infringement of any intellectual property or other rights arising out of the use of any information in this document, including, but not limited to, product data, diagrams, charts, programs, algorithms, and application circuit examples.
3. You should not use the products or the technology described in this document for the purpose of military applications such as the development of weapons of mass destruction or for the purpose of any other military use. When exporting the products or technology described herein, you should follow the applicable export control laws and regulations, and procedures required by such laws and regulations.
4. All information included in this document such as product data, diagrams, charts, programs, algorithms, and application circuit examples, is current as of the date this document is issued. Such information, however, is subject to change without any prior notice. Before purchasing or using any Renesas products listed in this document, please confirm the latest product information with a Renesas sales office. Also, please pay regular and careful attention to additional and different information to be disclosed by Renesas such as that disclosed through our website. (<http://www.renesas.com>)
5. Renesas has used reasonable care in compiling the information included in this document, but Renesas assumes no liability whatsoever for any damages incurred as a result of errors or omissions in the information included in this document.
6. When using or otherwise relying on the information in this document, you should evaluate the information in light of the total system before deciding about the applicability of such information to the intended application. Renesas makes no representations, warranties or guaranties regarding the suitability of its products for any particular application and specifically disclaims any liability arising out of the application and use of the information in this document or Renesas products.
7. With the exception of products specified by Renesas as suitable for automobile applications, Renesas products are not designed, manufactured or tested for applications or otherwise in systems the failure or malfunction of which may cause a direct threat to human life or create a risk of human injury or which require especially high quality and reliability such as safety systems, or equipment or systems for transportation and traffic, healthcare, combustion control, aerospace and aeronautics, nuclear power, or undersea communication transmission. If you are considering the use of our products for such purposes, please contact a Renesas sales office beforehand. Renesas shall have no liability for damages arising out of the uses set forth above.
8. Notwithstanding the preceding paragraph, you should not use Renesas products for the purposes listed below:
 - (1) artificial life support devices or systems
 - (2) surgical implantations
 - (3) healthcare intervention (e.g., excision, administration of medication, etc.)
 - (4) any other purposes that pose a direct threat to human lifeRenesas shall have no liability for damages arising out of the uses set forth in the above and purchasers who elect to use Renesas products in any of the foregoing applications shall indemnify and hold harmless Renesas Technology Corp., its affiliated companies and their officers, directors, and employees against any and all damages arising out of such applications.
9. You should use the products described herein within the range specified by Renesas, especially with respect to the maximum rating, operating supply voltage range, movement power voltage range, heat radiation characteristics, installation and other product characteristics. Renesas shall have no liability for malfunctions or damages arising out of the use of Renesas products beyond such specified ranges.
10. Although Renesas endeavors to improve the quality and reliability of its products, IC products have specific characteristics such as the occurrence of failure at a certain rate and malfunctions under certain use conditions. Please be sure to implement safety measures to guard against the possibility of physical injury, and injury or damage caused by fire in the event of the failure of a Renesas product, such as safety design for hardware and software including but not limited to redundancy, fire control and malfunction prevention, appropriate treatment for aging degradation or any other applicable measures. Among others, since the evaluation of microcomputer software alone is very difficult, please evaluate the safety of the final products or system manufactured by you.
11. In case Renesas products listed in this document are detached from the products to which the Renesas products are attached or affixed, the risk of accident such as swallowing by infants and small children is very high. You should implement safety measures so that Renesas products may not be easily detached from your products. Renesas shall have no liability for damages arising out of such detachment.
12. This document may not be reproduced or duplicated, in any form, in whole or in part, without prior written approval from Renesas.
13. Please contact a Renesas sales office if you have any questions regarding the information contained in this document, Renesas semiconductor products, or if you have any other inquiries.

IMPORTANT INFORMATION

READ FIRST

- **READ this user's manual before using this emulator product.**
- **KEEP the user's manual handy for future reference.**

Do not attempt to use the emulator product until you fully understand its mechanism.

Emulator Product:

Throughout this document, the term "emulator product" shall be defined as the following products produced only by Renesas Technology Corp. excluding all subsidiary products.

- Emulator station
- User system interface cables
- PC interface board
- Optional SIMM memory module
- Optional board

The user system or a host computer is not included in this definition.

Purpose of the Emulator Product:

This emulator product is a software and hardware development tool for systems employing the Renesas microcomputer (hereinafter referred to as the MCU). This emulator product must only be used for the above purpose.

Limited Applications:

This emulator product is not authorized for use in MEDICAL, atomic energy, aeronautical or space technology applications without consent of the appropriate officer of a Renesas sales company. Such use includes, but is not limited to, use in life support systems. Buyers of this emulator product must notify the relevant Renesas sales offices before planning to use the product in such applications.

Improvement Policy:

Renesas Technology Corp. (including its subsidiaries, hereafter collectively referred to as Renesas) pursues a policy of continuing improvement in design, performance, and safety of the emulator product. Renesas reserves the right to change, wholly or partially, the specifications, design, user's manual, and other documentation at any time without notice.

Target User of the Emulator Product:

This emulator product should only be used by those who have carefully read and thoroughly understood the information and restrictions contained in the user's manual. Do not attempt to use the emulator product until you fully understand its mechanism.

It is highly recommended that first-time users be instructed by users that are well versed in the operation of the emulator product.

LIMITED WARRANTY

Renesas warrants its emulator products to be manufactured in accordance with published specifications and free from defects in material and/or workmanship. Renesas, at its option, will repair or replace any emulator products returned intact to the factory, transportation charges prepaid, which Renesas, upon inspection, determine to be defective in material and/or workmanship.

The foregoing shall constitute the sole remedy for any breach of Renesas' warranty. See the Renesas warranty booklet for details on the warranty period. This warranty extends only to you, the original Purchaser. It is not transferable to anyone who subsequently purchases the emulator product from you. Renesas is not liable for any claim made by a third party or made by you for a third party.

DISCLAIMER

RENESAS MAKES NO WARRANTIES, EITHER EXPRESS OR IMPLIED, ORAL OR WRITTEN, EXCEPT AS PROVIDED HEREIN, INCLUDING WITHOUT LIMITATION THEREOF, WARRANTIES AS TO MARKETABILITY, MERCHANTABILITY, FITNESS FOR ANY PARTICULAR PURPOSE OR USE, OR AGAINST INFRINGEMENT OF ANY PATENT. IN NO EVENT SHALL RENESAS BE LIABLE FOR ANY DIRECT, INCIDENTAL OR CONSEQUENTIAL DAMAGES OF ANY NATURE, OR LOSSES OR EXPENSES RESULTING FROM ANY DEFECTIVE EMULATOR PRODUCT, THE USE OF ANY EMULATOR PRODUCT, OR ITS DOCUMENTATION, EVEN IF ADVISED OF THE POSSIBILITY OF SUCH DAMAGES. EXCEPT AS EXPRESSLY STATED OTHERWISE IN THIS WARRANTY, THIS EMULATOR PRODUCT IS SOLD "AS IS", AND YOU MUST ASSUME ALL RISK FOR THE USE AND RESULTS OBTAINED FROM THE EMULATOR PRODUCT.

State Law:

Some states do not allow the exclusion or limitation of implied warranties or liability for incidental or consequential damages, so the above limitation or exclusion may not apply to you. This warranty gives you specific legal rights, and you may have other rights which may vary from state to state.

The Warranty is Void in the Following Cases:

Renesas shall have no liability or legal responsibility for any problems caused by misuse, abuse, misapplication, neglect, improper handling, installation, repair or modifications of the emulator product without Renesas' prior written consent or any problems caused by the user system.

All Rights Reserved:

This user's manual and emulator product are copyrighted and all rights are reserved by Renesas. No part of this user's manual, all or part, may be reproduced or duplicated in any form, in hard-copy or machine-readable form, by any means available without Renesas' prior written consent.

Other Important Things to Keep in Mind:

1. Circuitry and other examples described herein are meant merely to indicate the characteristics and performance of Renesas' semiconductor products. Renesas assumes no responsibility for any intellectual property claims or other problems that may result from applications based on the examples described herein.
2. No license is granted by implication or otherwise under any patents or other rights of any third party or Renesas.

Figures:

Some figures in this user's manual may show items different from your actual system.

Limited Anticipation of Danger:

Renesas cannot anticipate every possible circumstance that might involve a potential hazard. The warnings in this user's manual and on the emulator product are therefore not all inclusive. Therefore, you must use the emulator product safely at your own risk.

SAFETY PAGE

READ FIRST

- **READ** this user's manual before using this emulator product.
- **KEEP the user's manual handy for future reference.**

Do not attempt to use the emulator product until you fully understand its mechanism.

DEFINITION OF SIGNAL WORDS



This is the safety alert symbol. It is used to alert you to potential personal injury hazards. Obey all safety messages that follow this symbol to avoid possible injury or death.



DANGER indicates an imminently hazardous situation which, if not avoided, will result in death or serious injury.



WARNING indicates a potentially hazardous situation which, if not avoided, could result in death or serious injury.



CAUTION indicates a potentially hazardous situation which, if not avoided, may result in minor or moderate injury.



CAUTION used without the safety alert symbol indicates a potentially hazardous situation which, if not avoided, may result in property damage.

NOTE emphasizes essential information.

WARNING

Observe the precautions listed below. Failure to do so will result in a FIRE HAZARD and will damage the user system and the emulator product or will result in PERSONAL INJURY. The USER PROGRAM will be LOST.

- 1. Do not repair or remodel the emulator product by yourself for electric shock prevention and quality assurance.**
- 2. Always switch OFF the E6000 emulator and user system before connecting or disconnecting any CABLES or PARTS.**
- 3. Always before connecting any CABLES, make sure that pin 1 on both sides are correctly aligned.**
- 4. Supply power according to the power specifications and do not apply an incorrect power voltage. Use only the provided power cable.**

CAUTION

This equipment has been tested and found to comply with the limits for a Class A digital device, pursuant to part 15 of the FCC Rules. These limits are designed to provide reasonable protection against harmful interference when the equipment is operated in a commercial environment. This equipment generates, uses, and can radiate radio frequency energy and, if not installed and used in accordance with the instruction manual, may cause harmful interference to radio communications. Operation of this equipment in a residential area is likely to cause harmful interference in which case the user will be required to correct the interference at his own expense.

Introduction

The E6000 emulator is an advanced realtime in-circuit emulator, which allows programs to be developed and debugged for the H8 family microcomputers.

The E6000 emulator can either be used without a user system, for developing and debugging software, or connected via a user system interface cable to a user system, for debugging user hardware.

High-performance Embedded Workshop is a Graphical User Interface intended to ease the development and debugging of applications written in C/C++ programming language and assembly language for Renesas microcomputers. Its aim is to provide a powerful yet intuitive way of accessing, observing and modifying the debugging platform in which the application is running.

High-performance Embedded Workshop is a powerful development environment for embedded applications targeted at Renesas microcontrollers. The main features are:

- A configurable build engine that allows you to set-up compiler, assembler and linker options via an easy to use interface.
- An integrated text editor with user customizable syntax coloring to improve code readability.
- A configurable environment to run your own tools.
- An integrated debugger which allows you to build and debug in the same application.
- Version control support.

High-performance Embedded Workshop has been designed with two key aims; firstly to provide you, the user, with a set of powerful development tools and, secondly, to unify and present them in a way that is easy to use.

About This Manual

This manual contains the following information.

Emulator Debugger Part: Preparation before use, E6000 emulator functions, debugging function, tutorial, and hardware and software specifications of the E6000 emulator.

Refer to the High-performance Embedded Workshop User's Manual for details on the information on the basic usage of the High-performance Embedded Workshop, customization of the environment, build functions, and debugging functions common to each High-performance Embedded Workshop product.

This manual does not intend to explain how to write C/C++ or assembly language programs, how to use any particular operating system or how best to tailor code for the individual devices. These issues are left to the respective manuals.

Microsoft®, MS-DOS, Windows®, Windows NT® are registered trademarks of Microsoft Corporation.

Visual SourceSafe is a trademark of Microsoft Corporation.

IBM is a registered trademark of International Business Machines Corporation.

All brand or product names used in this manual are trademarks or registered trademarks of their respective companies or organizations.

Document Conventions

This manual uses the following typographic conventions:

Table 1 Typographic Conventions

Convention	Meaning
[Menu->Menu Option]	Bold text with '>' is used to indicate menu options (for example, [File->Save As...]).
FILENAME.C	Uppercase names are used to indicate filenames.
"enter this string"	Used to indicate text that must be entered (excluding the "" quotes).
Key + Key	Used to indicate required key presses. For example, CTRL+N means press the CTRL key and then, whilst holding the CTRL key down, press the N key.
☞ (The "how to" symbol)	When this symbol is used, it is always located in the left hand margin. It indicates that the text to its immediate right is describing "how to" do something.

Components

Check all the components described in the component list unpacking. If the components are not complete, contact a Renesas sales office.

Contents

Emulator Debugger Part

Section 1 Overview	1
1.1 Features	1
1.2 Warnings	2
1.3 Environmental Conditions	3
1.4 Emulator External Dimensions and Mass	3
Section 2 Preparation before Use	5
2.1 Emulator Preparation	5
2.2 Installing Emulator's Software	5
2.3 Connecting to the User System	6
2.3.1 Example of Connecting the User System Interface Cable Head to the User System	6
2.3.2 Plugging the User System Interface Cable Body into the Emulator	7
2.3.3 Plugging the User System Interface Cable Body into the Cable Head	7
2.4 Power Supply	8
2.4.1 AC Adapter	8
2.4.2 Polarity	8
2.4.3 Power Supply Monitor Circuit	8
2.5 SIMM Memory Module	8
2.5.1 Optional SIMM Memory Module Configuration	8
2.6 Hardware Interface	9
2.6.1 Signal Protection on the emulator	9
2.6.2 User System Interface Circuits	9
2.6.3 Clock Oscillator	9
2.6.4 External Probe 1 (EXT1)/Trigger Output	9
2.6.5 External Probe 2 (EXT2)/Trigger Output	10
2.6.6 Voltage Follower Circuit	11
2.7 System Check	12
2.8 Communication Problems	17
2.9 Other Methods for Activating the Emulator	17
2.10 Uninstalling the Emulator's Software	17
Section 3 E6000 Emulator Functions	19
3.1 Debugging Features	19
3.1.1 Breakpoints	19
3.1.2 Trace	19
3.1.3 Execution Time Measurements	19
3.1.4 Performance Analysis	19
3.1.5 Bus Monitoring	20
3.2 Complex Event System (CES)	20
3.2.1 Event Channels	20
3.2.2 Range Channels	21
3.2.3 Breaks	21
3.2.4 Timing	21
3.3 Hardware Features	22
3.3.1 Memory	22
3.3.2 Clocks	23

3.3.3	Probes	23
3.4	Stack Trace Function	23
3.5	Online Help.....	23
Section 4 Preparation before Use		25
4.1	Method for Activating High-performance Embedded Workshop.....	25
4.1.1	Creating a New Workspace (Toolchain Not Used).....	26
4.1.2	Creating a New Workspace (Toolchain Used).....	30
4.1.3	Selecting an Existing Workspace.....	34
4.2	Connecting the Emulator	35
4.3	Reconnecting the Emulator.....	36
4.4	Ending the Emulator.....	36
Section 5 Debugging		37
5.1	Setting the Environment for Emulation	38
5.1.1	Opening the [Configuration Properties] Dialog Box	38
5.1.2	Selecting an MCU Not Included in the List.....	40
5.1.3	Selecting the Interface to be Connected.....	41
5.1.4	Opening the [Memory Mapping] Dialog Box.....	42
5.1.5	Changing the Memory Map Setting.....	43
5.2	Downloading a Program	44
5.2.1	Downloading a Program	44
5.2.2	Viewing the Source Code	45
5.2.3	Viewing the Assembly-Language Code.....	48
5.2.4	Modifying the Assembly-Language Code	49
5.2.5	Viewing a Specific Address.....	49
5.2.6	Viewing the Current Program Counter Address	49
5.3	Viewing the Current Status.....	50
5.4	Reading and Displaying the Emulator Information Regularly.....	51
5.4.1	Opening the [Extended Monitor] Window	51
5.4.2	Selecting Items to be Displayed.....	52
5.5	Displaying Memory Contents in Realtime.....	53
5.5.1	Opening the [Monitor] Window	53
5.5.2	Changing the Monitor Settings	55
5.5.3	Temporarily Stopping Update of the Monitor	55
5.5.4	Deleting the Monitor Settings.....	55
5.5.5	Monitoring Variables.....	55
5.5.6	Hiding the [Monitor] Window	56
5.5.7	Managing the [Monitor] Window	57
5.6	Viewing the Variables.....	58
5.6.1	[Watch] Window.....	58
5.7	Using the Event Points.....	60
5.7.1	Software Breakpoints.....	60
5.7.2	Event Points	60
5.7.3	Event Detection System.....	60
5.7.4	Signals to Indicate Bus States and Areas	61
5.7.5	Opening the [Event] Window	62
5.7.6	Setting Software Breakpoints.....	62
5.7.7	Setting Event Points.....	64
5.7.8	Setting Trigger Points	72
5.7.9	Editing Event Points	73
5.7.10	Modifying Event Points	73
5.7.11	Enabling an Event Point.....	73

5.7.12	Disabling an Event Point.....	73
5.7.13	Deleting an Event Point	73
5.7.14	Deleting All Event Points	73
5.7.15	Viewing the Source Line for an Event Point.....	73
5.8	Viewing the Trace Information	74
5.8.1	Opening the [Trace] Window	74
5.8.2	Acquiring Trace Information	74
5.8.3	Specifying Trace Acquisition Conditions	76
5.8.4	Searching for a Trace Record.....	84
5.8.5	Clearing the Trace Information.....	93
5.8.6	Saving the Trace Information in a File.....	93
5.8.7	Viewing the [Editor] Window.....	94
5.8.8	Trimming the Source	94
5.8.9	Acquiring a Snapshot of the Trace Information.....	94
5.8.10	Temporarily Stopping Trace Acquisition.....	94
5.8.11	Restarting Trace Acquisition	94
5.8.12	Extracting Records from the Acquired Information.....	95
5.8.13	Calculating the Difference in Time Stamping.....	105
5.8.14	Analyzing Statistical Information	106
5.8.15	Extracting Function Calls from the Acquired Trace Information	107
5.9	Analyzing Performance.....	108
5.9.1	Opening the [Performance Analysis] Window	110
5.9.2	Setting Conditions for Measurement	111
5.9.3	Selecting the Address Detection Mode and Resolution	118
5.9.4	Starting Performance Data Acquisition	118
5.9.5	Deleting a Measurement Condition	118
5.9.6	Deleting All Measurement Conditions.....	118
Section 6 Tutorial.....		119
6.1	Introduction.....	119
6.2	Running the High-performance Embedded Workshop.....	120
6.3	Downloading the Tutorial Program	121
6.3.1	Downloading the Tutorial Program.....	121
6.3.2	Displaying the Source Program.....	122
6.4	Setting a Software Breakpoint	123
6.5	Setting Registers	124
6.6	Executing the Program.....	125
6.7	Reviewing Breakpoints.....	128
6.8	Referring to Symbols.....	129
6.9	Viewing Memory.....	130
6.10	Watching Variables.....	131
6.11	Displaying Local Variables.....	134
6.12	Stepping Through a Program	135
6.12.1	Executing the [Step In] Command	135
6.12.2	Executing the [Step Out] Command	137
6.12.3	Executing the [Step Over] Command	138
6.13	Forced Breaking of Program Executions	139
6.14	Resetting the MCU	139
6.15	Break Function.....	140
6.15.1	Software Break Function.....	140
6.15.2	Breaking Execution at Event Points.....	145
6.16	Trace Functions.....	149
6.16.1	Displaying a Trace (when Time Stamping is not Available)	150

6.16.2	Displaying a Trace (when Time Stamping is Available)	156
6.16.3	Statistics	160
6.16.4	Function Calls	164
6.17	Stack Trace Function	165
6.18	Performance Measurement Function	167
6.18.1	Time Of Specified Range Measurement	167
6.19	Monitor Function	170
6.20	What Next?	172
Section 7 Hardware Specifications Specific to This Product		173
7.1	H8/3664 E6000 Emulator Specifications	173
7.1.1	Supported Items	173
7.1.2	Operating Voltage and Frequency Specifications	174
7.2	User System Interface	175
7.2.1	Signal Protection	175
7.2.2	User System Interface Circuits	175
7.3	Differences between MCU and Emulator	177
7.3.1	A/D Converter and D/A Converter	177
7.4	Handling Serial EEPROM Board	178
7.5	Host PC Interface	179
Section 8 Software Specifications Specific to This Product		181
8.1	Software Specifications of the H8/3664 E6000 Emulator	181
8.1.1	Target Hardware	181
8.1.2	Selectable Platforms	181
8.1.3	[Configuration Properties] Dialog Box ([General] Page)	182
8.1.4	[Configuration Properties] Dialog Box ([Custom] Page)	187
8.1.5	Memory Mapping Function	190
8.1.6	[Status] Window	190
8.1.7	Extended Monitor Function	192
8.1.8	Signals to Indicate Bus States and Areas	193
8.1.9	Monitoring Function	193
8.1.10	Trigger Points	193
8.1.11	Trace Information	194
8.1.12	Searching for a Trace Record	195
8.1.13	Trace Filtering Function	195
8.1.14	Reading from and Writing to the EEPROM	196
8.2	Notes on Usage of the H8/3664 E6000 Emulator	202
8.2.1	I/O Register	202
8.2.2	Notes on Mode Transitions	226
8.2.3	Access to the Reserved Area	226
8.2.4	Environment for Execution of the Tutorial Program	226
8.2.5	Note on Emulation of the H8/36912 Group and H8/36902 Group	227
Appendix A I/O File Format		229
A.1	File format (Bit Field Not Supported)	229
A.2	File format (Bit Field Supported)	231
Appendix B Menus		233
Appendix C Command Lines		237
Appendix D Diagnostic Test Procedure		241

D.1 System Set-Up for Test Program Execution241
D.2 Diagnostic Test Procedure Using Test Program242

Emulator Debugger Part

Section 1 Overview

1.1 Features

- The breakpoint, memory map, performance, and trace can be set through the dialog box.
 - Intuitive user interface
 - Online help
 - Common display and operability
- Supported host interfaces
The PCI interface, PC card (PCMCIA) interface, USB interface, or LAN interface can be used for connecting to the host computer.
- Realtime emulation
Realtime emulation of the user system is enabled at the maximum operating frequency of the CPU.
- Excellent operability
Using the High-performance Embedded Workshop enables user program debugging using a pointing device such as a mouse. The High-performance Embedded Workshop enables high-speed downloading of load module files.
- Various debugging functions
Various break and trace functions enable efficient debugging. Breakpoints and break conditions can be set by the specific window, trace information can be displayed on a window, and command-line functions can be used.
- Memory access during emulation
During emulation, the memory contents can be read and modified.

1.2 Warnings

CAUTION

READ the following warnings before using the emulator product. Incorrect operation will damage the user system and the emulator product. The USER PROGRAM will be LOST.

1. Check all components against the component list after unpacking the emulator.
2. Never place heavy objects on the casing.
3. Do not place the emulator in places where:
 - The temperature becomes high such as in direct sunlight or near a heater. For details, refer to section 1.3, Environmental Conditions.
 - The temperature or humidity changes greatly.
 - There is a lot of dust.
 - There is a lot of vibration. For details, refer to section 1.3, Environmental Conditions.
4. Protect the emulator from excessive impacts and stresses.
5. Only supply the specified voltage and power-supply frequency.
6. When moving the emulator, take care not to vibrate or damage it.
7. After connecting the cable, check that it is connected correctly. For details, refer to section 2, Preparation before Use. Supply power to the connected equipment after connecting all cables. For the supplying procedures, refer to section 2.7, System Check. Cables must not be connected or disconnected while the power is on.

1.3 Environmental Conditions

CAUTION

Observe the conditions listed in table 1.1 when using the emulator. Failure to do so will cause illegal operation in the user system, the emulator product, and the user program.

Table 1.1 Environmental Conditions

Item	Specifications
Temperature	Operating: +10°C to +35°C Storage: -10°C to +50°C
Humidity	Operating: 35% RH to 80% RH, no condensation Storage: 35% RH to 80% RH, no condensation
Vibration	Operating: 2.45 m/s ² max. Storage: 4.9 m/s ² max. Transportation: 14.7 m/s ² max.
Ambient gases	No corrosive gases may be present

1.4 Emulator External Dimensions and Mass

Table 1.2 Emulator External Dimensions and Mass

Item	Specifications
Dimensions	219 × 170 × 54 mm
Mass	Approximately 850 g

Section 2 Preparation before Use

2.1 Emulator Preparation

Unpack the emulator and prepare it for use as follows:

 **WARNING**

READ the reference sections shaded in figure 2.1 before using the emulator product. Incorrect operation will damage the user system and the emulator product. The USER PROGRAM will be LOST.

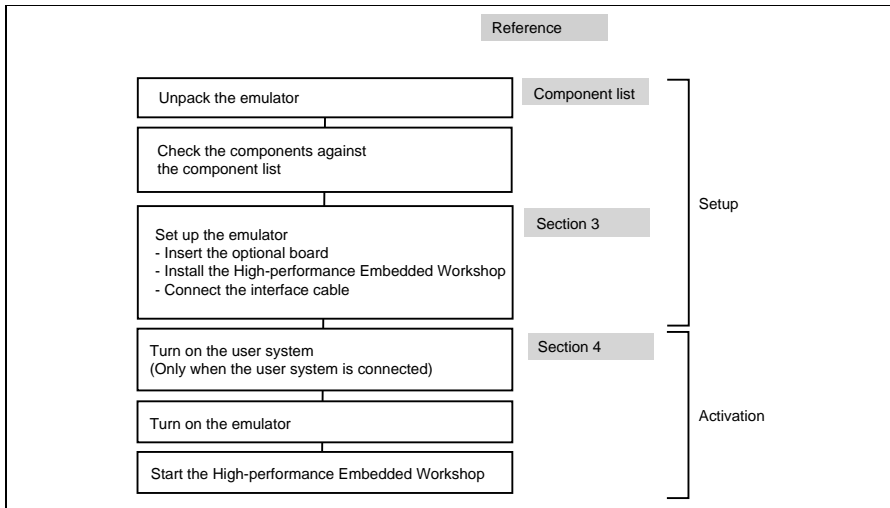

Figure 2.1 Emulator Preparation Flowchart

2.2 Installing Emulator's Software

To install the High-performance Embedded Workshop, refer to the Setup Guide for the E6000 Emulator supplied together with the emulator.

2.3 Connecting to the User System

To connect the emulator to a user system, proceed as follows:

- Connect the user system interface cable head to the user system.
- Plug the cable body into the emulator.
- Plug the cable body into the cable head.

For details of these steps, refer to the User System Interface Cable User's Manual.

Figure 2.2 gives details of the connectors provided on the emulator.

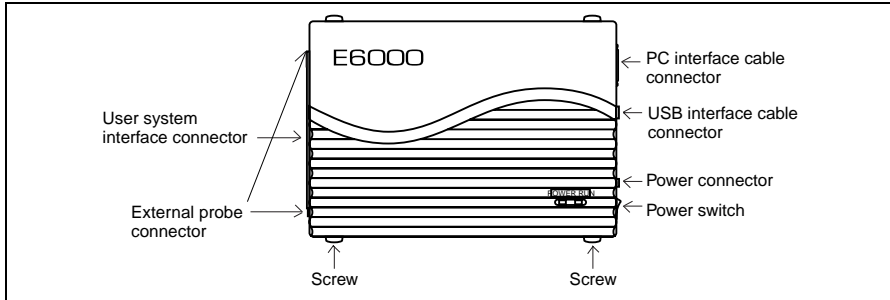

Figure 2.2 E6000 Emulator Connectors

2.3.1 Example of Connecting the User System Interface Cable Head to the User System

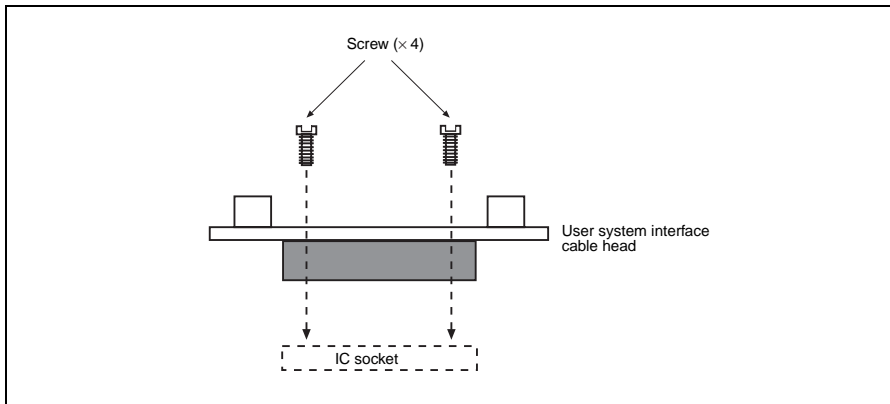

Figure 2.3 Example of Connecting User System Interface Cable Head to User System

- Ensure that all power is off to the emulator and the user system.
- Insert the cable head into the socket on the user system.

Note: Depending upon the package, it may be possible to orientate this cable head in any position on the socket, so care should be taken to correctly identify pin 1 on the emulator and socket when installing.

- Screw the cable head to the socket with the screws provided. Progressively tighten the screws in the sequence shown in figure 2.4 until all are 'finger tight'.

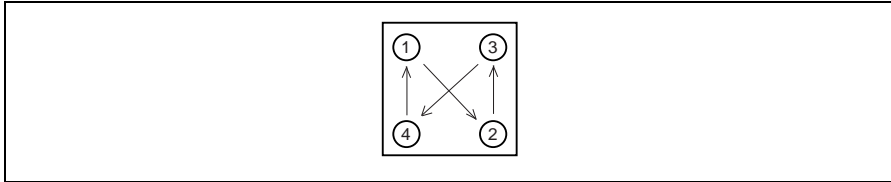

Figure 2.4 Sequence of Screw Tightening

Note: Be careful not to over-tighten the screws as this may result in contact failure on the user system or damage the cable head. Where provided, use the 'solder lugs' on the QFP socket to provide extra strength to the emulator/user system connection.

2.3.2 Plugging the User System Interface Cable Body into the Emulator

Plug the cable body into the emulator, taking care to insert it straight, and push it firmly into place.

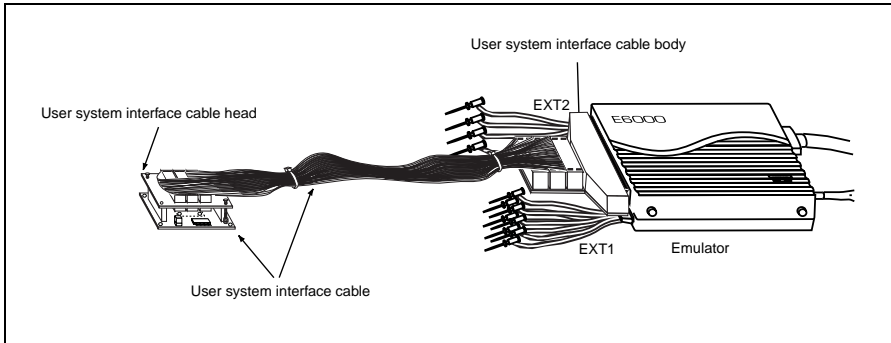

Figure 2.5 Plugging User System Interface Cable Body to Emulator

2.3.3 Plugging the User System Interface Cable Body into the Cable Head

Plug the cable body into the cable head on the user system.

2.4 Power Supply

2.4.1 AC Adapter

The AC adapter supplied with the emulator must be used at all times.

2.4.2 Polarity

Figure 2.6 shows the polarity of the power-supply plug.

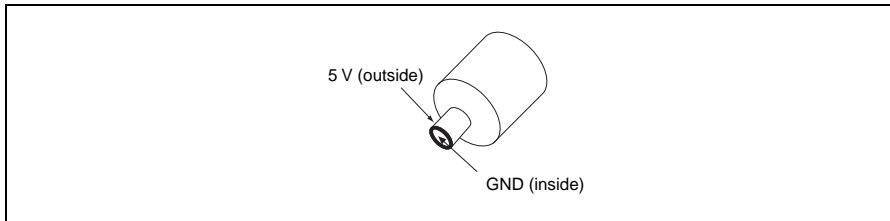

Figure 2.6 Polarity of Power Supply Plug

2.4.3 Power Supply Monitor Circuit

The emulator incorporates a power supply monitor circuit which only lights the green LED when a voltage higher than 4.75 V is supplied. If this LED is not illuminated, you should check the emulator voltage level. An input voltage less than 4.75 V could indicate that enough current cannot be supplied to the emulator.

Note: Use the provided AC adapter for the emulator.

2.5 SIMM Memory Module

E6000 emulator's optional SIMM memory modules are available which provide emulation memory for user code without needing a user system. The optional SIMM memory modules are available in different memory size, but all are partitioned into four equal banks. These banks can be relocated on page boundaries anywhere in the user area. Note that, however, some products do not support the SIMM memory module.

2.5.1 Optional SIMM Memory Module Configuration

The configuration of the optional SIMM memory module is controlled by the mapping RAM. Opening the [Memory] sheet of the [System Status] window allows you to check which optional SIMM memory module, if any, is installed and also allows the four banks to be relocated to the required addresses from the [Memory Mapping] dialog box.

2.6 Hardware Interface

All signals are directly connected to the MCU in the emulator with no buffering with the exception of those listed in section 7, Hardware Specifications Specific to This Product.

2.6.1 Signal Protection on the emulator

All signals are over/under voltage protected by use of diode arrays. The only exceptions being the AV_{cc} and V_{ref} .

All ports have pull-up resistors except for analog port.

All V_{cc} pins on the cable head assembly are connected together (with the exception of the AV_{cc} pin), and are then monitored by the emulator to detect powered user system presence.

2.6.2 User System Interface Circuits

The interface circuit between the MCU in the emulator and the user system has a signal delay of about 8 ns due to the user system interface cable and it includes pull-up resistors. Therefore, high-impedance signals will be pulled up to the high level. When connecting the emulator to a user system, adjust the user system to compensate for propagation delays.

The following diagrams show the equivalent circuit examples of the interface signals. The interface circuits depend on the MCU type. For details, refer to section 7, Hardware Specifications Specific to This Product.

2.6.3 Clock Oscillator

The oscillator circuit has been implemented on the user system interface cable head. For details on the oscillator circuit, refer to the user's manual for each user system interface cable.

2.6.4 External Probe 1 (EXT1)/Trigger Output

An 8-pin connector, marked EXT1 (on the right under the user system interface cable connector), on the emulator case accommodates four external probe inputs and two trigger outputs. The pin assignment of this connector is shown in figure 2.7.

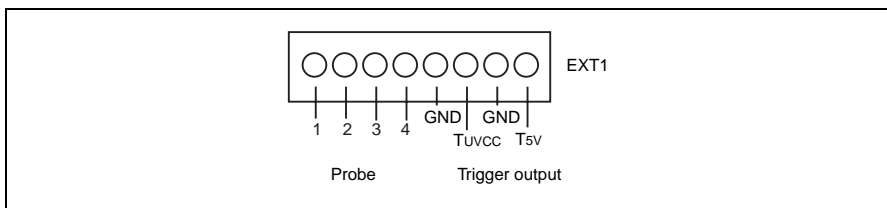

Figure 2.7 External Probe Connector 1

The interface circuit for the external probe 1 is shown in figure 2.8.

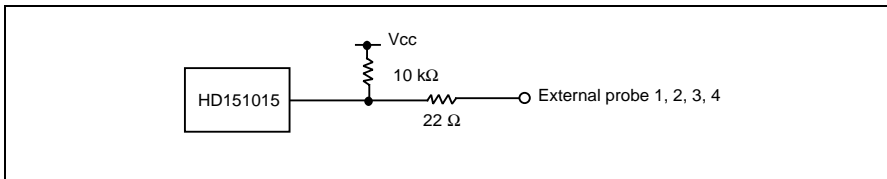

Figure 2.8 Interface Circuit for External Probe 1

The trigger output is controlled by event channel 8 and is an active low signal. The trigger output is available as either T5V (within the range from 2.5 V to 5 V; does not depend on the user V_{cc} level) or TUV_{cc} (the user V_{cc} level).

2.6.5 External Probe 2 (EXT2)/Trigger Output

A 6-pin connector, marked EXT2 (on the left under the user system interface cable connector), on the emulator case accommodates four trigger outputs. The pin assignment of this connector is shown in figure 2.9.

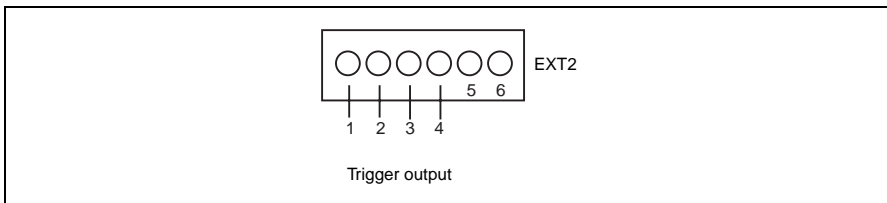

Figure 2.9 External Probe 2 Connector

The trigger output is an active high signal which is output during the read or write cycles when a trace condition (1 to 4) of the bus monitor function is satisfied. The trigger output is available as user V_{cc} level. Note that, however, some products do not support the external probe 2 (EXT2).

2.6.6 Voltage Follower Circuit

CAUTION

1. Do not connect the user system interface cable to the emulator without user system connection.
2. Turn on the user system before starting up the emulator.

A voltage follower circuit is implemented on the emulator which allows the user system voltage level from the user system to be monitored. This monitored voltage level is automatically supplied to the logic on the emulator and is derived from the emulator power supply unit. This means that no power is taken from the user system board.

If no user system interface cable is connected to the emulator, the emulator will operate at a specified voltage and all clock frequencies will be available to the user. If the user system interface cable is attached, the emulator will match the voltage supplied to the user target in all cases; i.e. even when the user V_{cc} is below the operating voltage for the MCU. You must be careful not to select an invalid clock frequency. When the emulator is connected to the user system and the user system is turned off, the voltage follower circuit output voltage level is 0 V. In this case, the emulator will not operate correctly.

You can set a user V_{cc} threshold in the range $V_{cc} \text{ max.} - 0 \text{ V}$ by using the emulator configuration dialog box. If the user V_{cc} drops below this threshold, [User System Voltage] in the [Extended Monitor] window will display Down, otherwise OK is displayed.

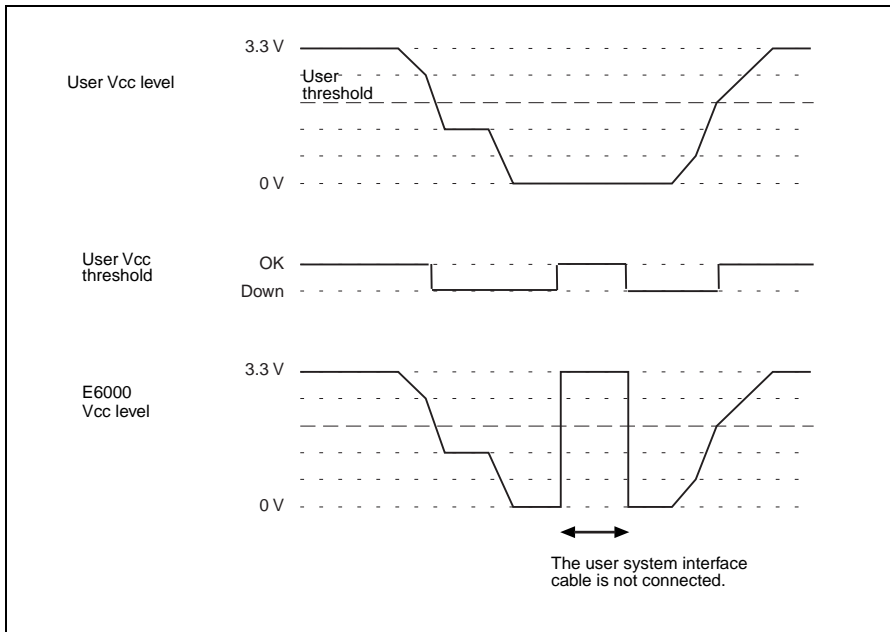

Figure 2.10 Voltage Level Monitoring (Example for $V_{cc} = 3.3 \text{ V}$)

2.7 System Check

When the software is executed, use the procedure below to check that the emulator is connected correctly. Here, use the workspace for a tutorial provided on the product.

Refer to section 2.9, Other Methods for Activating the Emulator, for the other activating method to create a new project or use a workspace for the High-performance Embedded Workshop of the old version.

1. Connect the emulator to the host computer.
2. Connect the user system interface cable to the connector of the emulator.
3. Turn on the emulator.
4. Activate the High-performance Embedded Workshop from the [Programs] in the [Start] menu (figure 2.11).

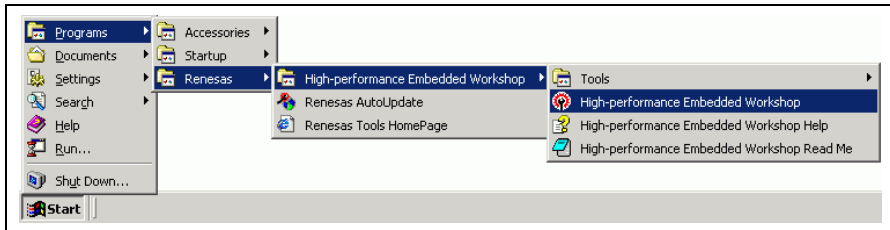

Figure 2.11 [Start] Menu

Note: If 'LAN Driver' is not selected at installation, [Tools] is not displayed.

5. The [Welcome!] dialog box is displayed.

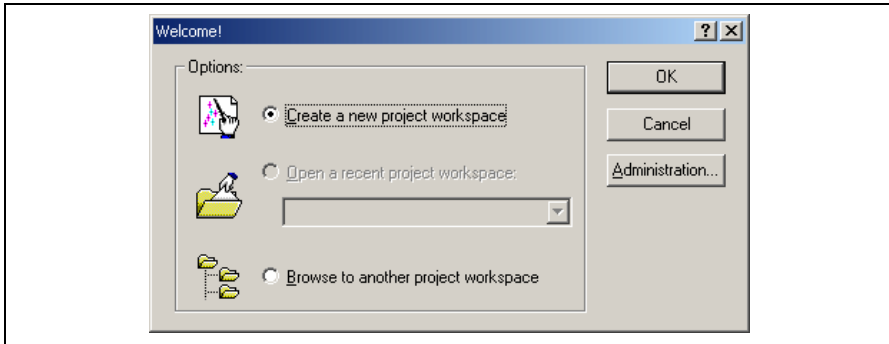

Figure 2.12 [Welcome!] Dialog Box

To use a workspace for the tutorial, select the [Browse to another project workspace] radio button and click the [OK] button.

When the [Open Workspace] dialog box is opened, specify the following directory:
OS installation drive \Workspace\Tutorial\E6000\xxxx

Note: The directory mentioned above cannot be specified depending on the version of the software. In such cases, specify the following directory instead.

High-performance Embedded Workshop installation destination directory
\Tools\Renesas\DebugComp\Platform\E6000\xxxx\Tutorial

After the directory has been specified, select the following file and click the [Open] button.

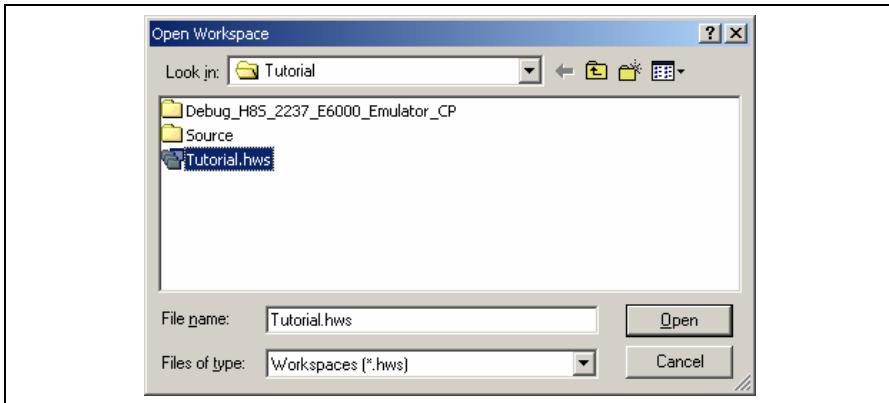

Figure 2.13 [Open Workspace] Dialog Box

When no compiler package or that of a different version is installed, the following message box will be displayed.



Figure 2.14 Message Box

6. The [E6000 Driver Details] dialog box is displayed. This dialog box is only displayed at the first initiation. When only one of interface drivers is selected, this dialog box is not displayed.

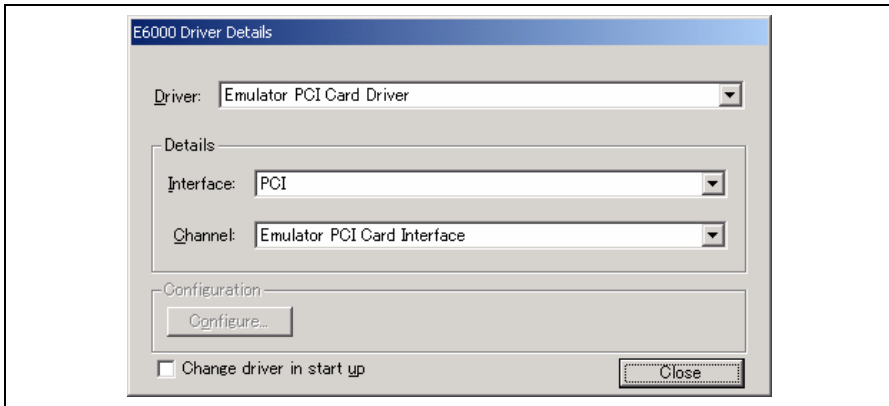

Figure 2.15 [E6000 Driver Details] Dialog Box

- In the [Driver] combo box, select the driver to connect the emulator.
- [Interface] displays the name of the interface to be connected.
- Click the [Close] button.

7. Set up the emulator. During this process, the following dialog box is displayed.

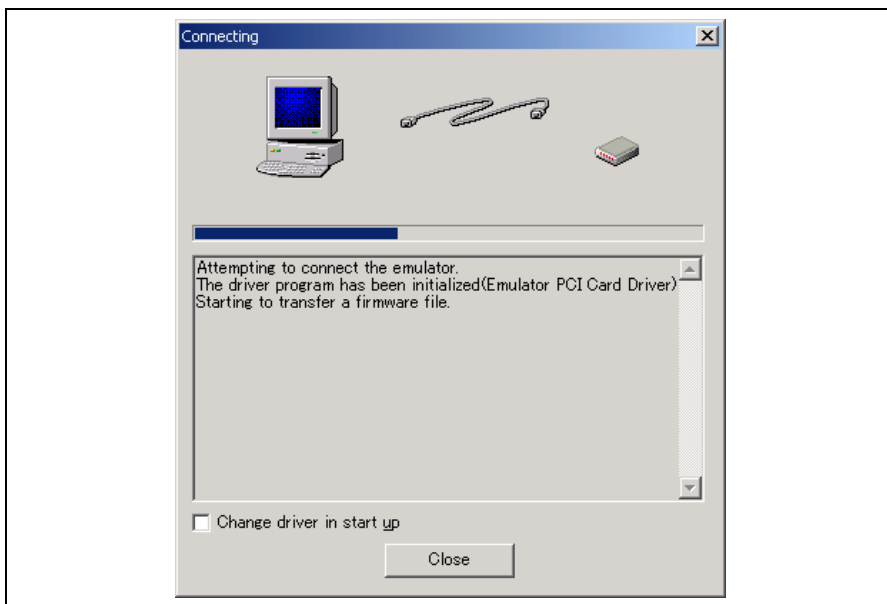

Figure 2.16 [Connecting] Dialog Box

- When "Connected" is displayed in the [Output] window of the High-performance Embedded Workshop, the emulator initiation is completed.

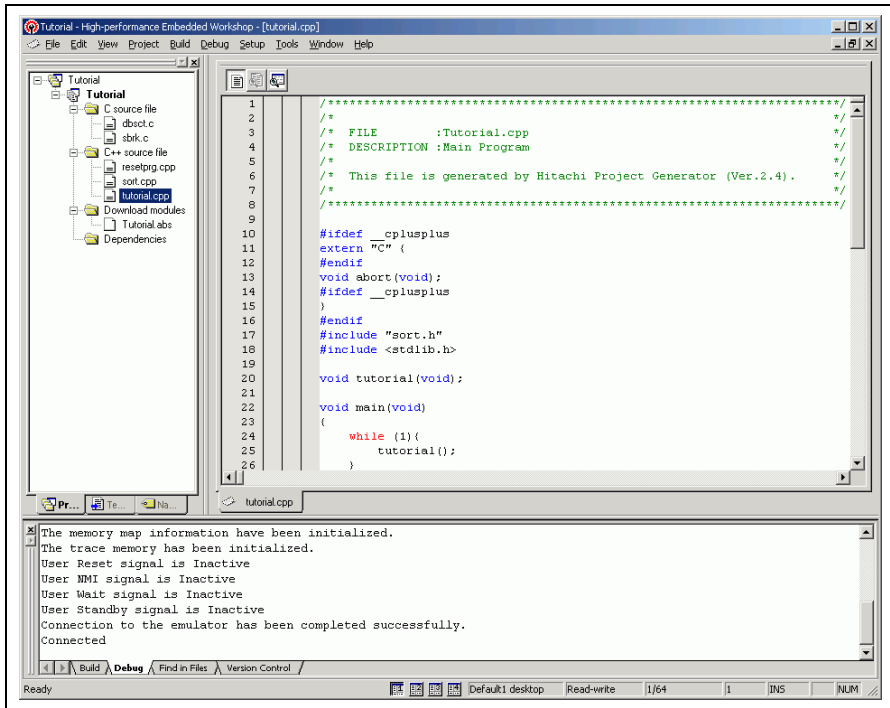

Figure 2.17 High-performance Embedded Workshop Window

2.8 Communication Problems

The following message box will be displayed when the emulator power is turned off or the PC interface cable is not correctly connected.

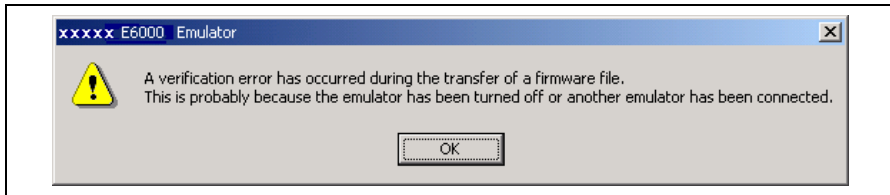

Figure 2.18 Error Message

For information on other errors, refer to the Setup Guide for the E6000 Emulator.

2.9 Other Methods for Activating the Emulator

Refer to section 4, Preparation before Use.

2.10 Uninstalling the Emulator's Software

For details on uninstallation, refer to the Setup Guide for the E6000 Emulator.

Section 3 E6000 Emulator Functions

3.1 Debugging Features

3.1.1 Breakpoints

The emulator provides a comprehensive range of alternative types of breakpoints, to give you the maximum flexibility in debugging applications and user system.

Hardware Break Conditions: Up to 12 break conditions can be defined using the event and range channels in the complex event system (CES). For more information about the hardware break conditions, see section 3.2, Complex Event System (CES).

Software Breakpoints: Up to 256 software breakpoints can be defined. These software breakpoints are set by replacing the user instruction by a BREAK instruction. In target ROM, only one breakpoint (on-chip break) can be set.

3.1.2 Trace

The emulator incorporates a powerful realtime trace facility which allows you to examine MCU activity in detail. The realtime trace buffer holds up to 32768 bus cycles, and it is continuously updated during execution. The buffer is configured as a rolling buffer, which can be stopped during execution and read back by the host computer without halting emulation.

The data stored in the trace buffer is displayed in both source program and assembly languages for ease of debugging. However, if trace filtering is used, only assembly language can be displayed.

The buffer can be set up to store all bus cycles or just selected cycles. This is called trace acquisition and uses the complex event system (CES) to select the parts of the program you are interested in.

It is also possible to store all bus cycles and then just look at selected cycles. This is called trace filtering.

3.1.3 Execution Time Measurements

The emulator allows you to measure the total execution time, or to measure the time of execution between specified events in the complex event system. You can set the resolution of the timer to any of the following values:

20 ns, 125 ns, 250 ns, 500 ns, 1 μ s, 2 μ s, 4 μ s, 8 μ s, or 16 μ s.

At 20 ns the maximum time that can be measured is about six hours, and at 16 μ s the maximum time is about 200 days.

3.1.4 Performance Analysis

The emulator provides functions for measuring the performance of a program. The performance of the specified program range can be displayed either as a histogram or in percentage form. A timer resolution of 20 ns, 40 ns, or 160 ns can be selected. In addition, the execution count of the specified program range can be measured (1 to 65535).

3.1.5 Bus Monitoring

The emulator incorporates a bus monitoring function that monitors and displays the contents of the accessed area in High-performance Embedded Workshop windows without stopping the program execution. Up to eight blocks of 256 bytes can be monitored. In addition, the emulator can output trigger signals from external probe 2 (EXT2) when specified addresses (four points max.) are accessed. Note that, however, some products do not support the bus monitoring function.

3.2 Complex Event System (CES)

In most practical debugging applications, the program or hardware errors that you are trying to debug occur under a certain restricted set of circumstances. For example, a hardware error may only occur after a specific area of memory has been accessed. Tracking down such problems using simple software breakpoints can be very time-consuming.

The emulator provides a very sophisticated system for giving a precise description of the conditions you want to examine, called the complex event system. This allows you to define events which depend on the state of a specified combination of the MCU signals.

The complex event system provides a unified way of controlling the trace, break, and timing functions of the emulator.

3.2.1 Event Channels

The event channels allow you to detect when a specified event has occurred. The event can be defined as a combination of one or more of the followings:

- Address or address range
- Address outside range
- Read or Write or either
- Data, with an optional mask
- MCU access type (e.g., DMAC and instruction prefetch)
- MCU access area (e.g., on-chip ROM and on-chip RAM)
- A signal state on one or more of the four external probes
- A certain number of times that the event must be triggered
- Delay cycles after an event

Up to eight events can be combined into a sequence, in which each event is either activated or deactivated by the occurrence of the previous event in the sequence. For example, you can cause a break if an I/O register is written to after a specified area of RAM has been accessed.

3.2.2 Range Channels

The range channels can be set up to be triggered on a combination of one or more of the following:

- Address or address range (inside the range)
- Read or Write or either
- Data, with an optional mask
- MCU access type (e.g., DMAC and instruction prefetch)
- MCU access area (e.g., on-chip ROM and on-chip RAM)
- A signal state on one or more of the four external probes
- Delay cycles after an event

The complex event system can be used to control the following functions of the emulator:

3.2.3 Breaks

Use breaks to interrupt program execution when a specified event, or sequence of events, is activated. For example, you can set up a break to halt execution when the program reads from one address, and then writes to another address. The break can also optionally be delayed by up to 65535 bus cycles.

3.2.4 Timing

You can set up two events and then measure the execution time of the program between the activation of the first event and second event.

3.3 Hardware Features

3.3.1 Memory

The emulator provides standard emulation memory as the substitute for on-chip ROM memory and on-chip RAM memory. When a device type or device mode without an on-chip ROM or on-chip RAM is selected, the standard emulation memory is disabled. When debugging with only the emulator and the user program and data are stored in an external address space, an optional SIMM memory module must be used. The optional SIMM memory modules can be separately purchased.

The emulation memory can be mapped in 64-byte units to any number of separate memory blocks in the MCU address space. Each memory block can be specified using the memory mapping function as user (Target) or emulator (SIMM memory module) and, in each case, the access can be specified as read-write, read-only, or guarded.

The definition of each type of memory is as follows:

Table 3.1 Memory Types

Memory Type	Description
On-chip	Uses the MCU on-chip memory.
User	Accesses the user system memory.
Emulator	Accesses the emulator SIMM memory module.

The contents of a specified block of memory can be displayed using the memory function. The contents of memory can be modified at any time, even during program execution and the results are immediately reflected in all other appropriate windows.

Note that modifying memory contents during program execution has the following time requirements:

1. MCU on-chip ROM or RAM, or emulator SIMM memory module
The emulator modifies the memory contents by temporarily switching the memory bus to the emulator side without stopping the user program execution. Therefore, the emulator uses the memory bus for up to 80 μ s in reading of 256 bytes (25 MHz, on-chip ROM).
2. MCU on-chip I/O, DTCRAM, or user system memory
The emulator stops the user program execution, then modifies the memory contents. Therefore, the user program stops for a maximum of 2 ms in reading 256 bytes (25 MHz, emulation memory).

3.3.2 Clocks

The clock can be specified as emulator internal clock or target clock. The frequencies that can be specified as the emulator internal clock depend on the MCU. For details, refer to section 8, Software Specifications Specific to This Product.

3.3.3 Probes

External probes 1 and 2 (EXT1 and EXT2) can be connected to the emulator, to make use of signals on the user system for break or trace. The signal for external probe 1 can be set as the condition for the event detection system depending on the low or high level. Since the signal for external probe 2 outputs high level when the trigger setting (1 to 4) condition is matched in the bus monitor function, the signal can be used for the trigger condition for such as an oscilloscope.

3.4 Stack Trace Function

The emulator uses the stack's information to display the name of the calling function for a function at which the program counter is currently pointing. This function can be used only when the load module that has the Dwarf2-type debugging information is loaded. For the usage of this function, refer to section 6.17, Stack Trace Function.

3.5 Online Help

An online help explains the usage of each function or the command syntax that can be entered from the command line window.

Select [Emulator Help] from the [Help] menu to view the emulator help.

Section 4 Preparation before Use

4.1 Method for Activating High-performance Embedded Workshop

To activate the High-performance Embedded Workshop, follow the procedure listed below.

1. Connect the emulator to the host computer.
2. Connect the user system interface cable to the connector of the emulator if you use the user system interface cable. This is not necessary when you do not use the user system interface cable.
3. Turn on the emulator. Be sure to turn on the user system before supplying power to the emulator if you use the user system.
4. Activate the High-performance Embedded Workshop from [Programs] in the [Start] menu.
5. The [Welcome!] dialog box is displayed.

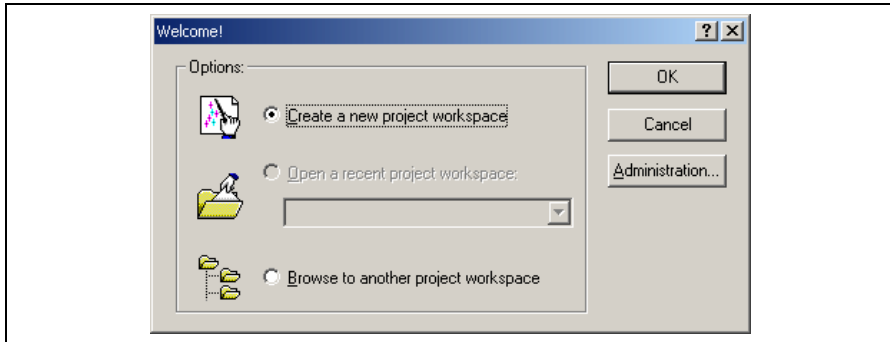

Figure 4.1 [Welcome!] Dialog Box

[Create a new project workspace] radio button: Creates a new workspace.

[Open a recent project workspace] radio button: Uses an existing workspace and displays the history of the opened workspace.

[Browse to another project workspace] radio button: Uses an existing workspace; this radio button is used when the history of the opened workspace does not remain.

In this section, we describe the following three ways to start up the High-performance Embedded Workshop:

- [Create a new project workspace] - a toolchain is not in use
- [Create a new project workspace] - a toolchain is in use
- [Browse to another project workspace]

The method to create a new workspace depends on whether a toolchain is or is not in use. Note that this emulator product does not include a toolchain. Use of a toolchain is available in an environment where the H8S, H8/300 series C/C++ compiler package has been installed. For details on this, refer to the manual attached to the H8S, H8/300 series C/C++ compiler package.

4.1.1 Creating a New Workspace (Toolchain Not Used)

1. In the [Welcome!] dialog box that is displayed when the High-performance Embedded Workshop is activated, select [Create a new project workspace] radio button and click the [OK] button.

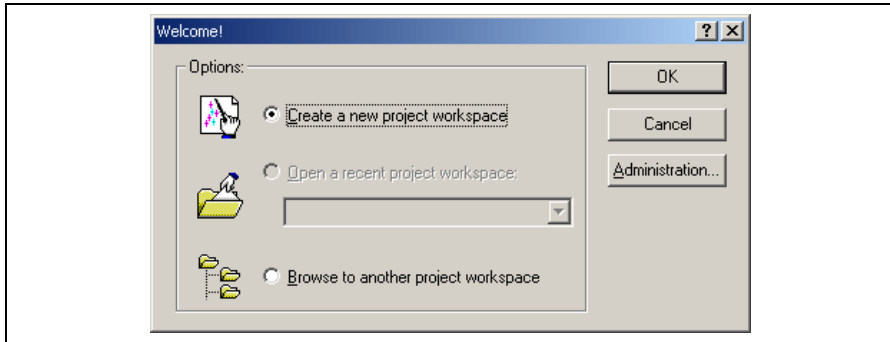

Figure 4.2 [Welcome!] Dialog Box

2. Creation of a new workspace is started. The following dialog box is displayed.

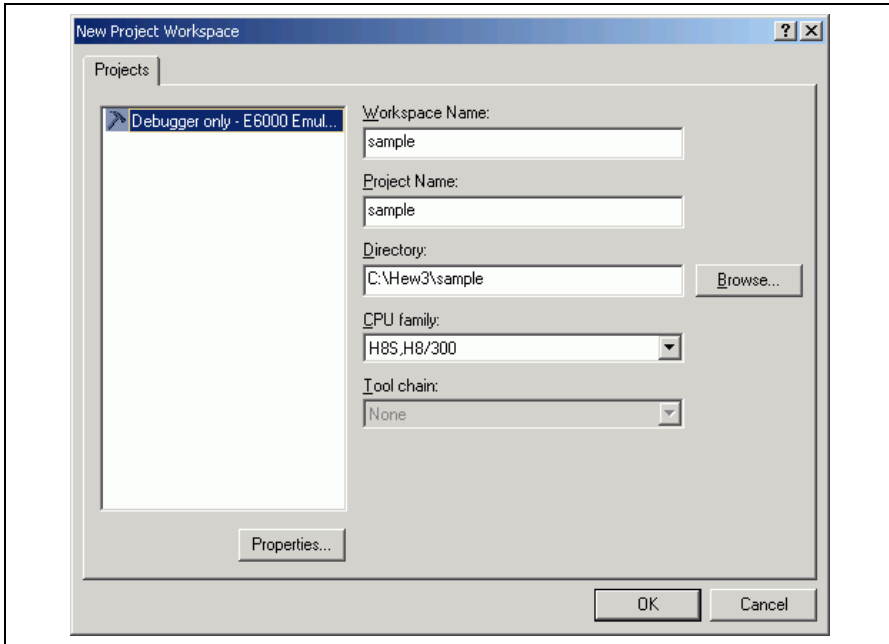

Figure 4.3 [New Project Workspace] Dialog Box

[Workspace Name] edit box: Enter the new workspace name.

[Project Name] edit box: Enter the project name. When the project name is the same as the workspace name, it needs not be entered.

[Directory] edit box: Enter the directory name in which the workspace will be created. Click the [Browse...] button to select a directory.

[CPU family] combo box: Select the target CPU family.

Other list boxes are used for setting the toolchain; the fixed information is displayed when the toolchain has not been installed.

Click the [OK] button.

3. Select the target platform of the session file. The following dialog box is displayed.

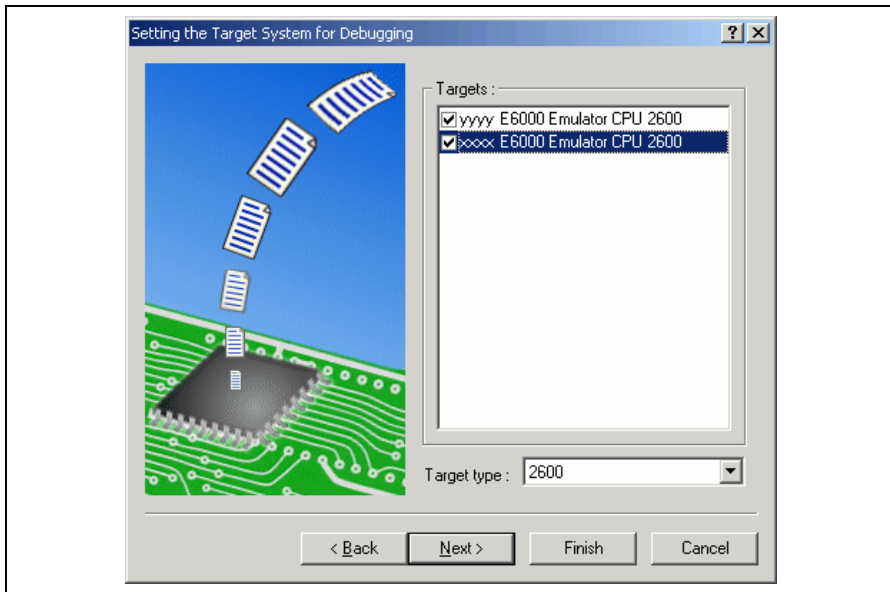

Figure 4.4 [New Project – Step 7] Dialog Box

The target platform for the session file used when the High-performance Embedded Workshop is activated must be selected here. Check the box against the target platform and then click the [Next] button. For details on the session file, refer to the High-performance Embedded Workshop user's manual.

4. Set the configuration file name.

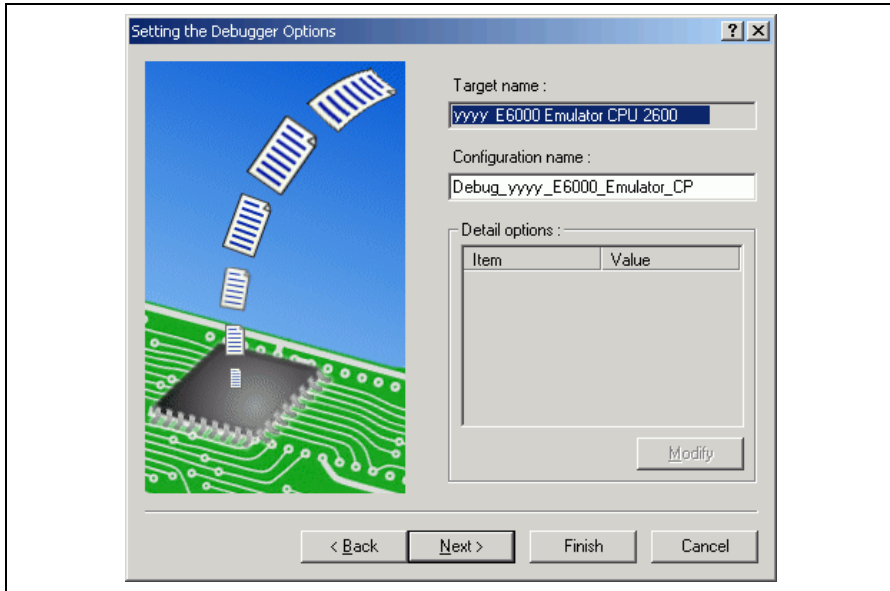

Figure 4.5 [New Project – Step 8] Dialog Box

If multiple target platforms were selected in the [New Project – Step 7] dialog box shown in figure 4.5, set the name of a configuration file for each of them, each time pressing the [Next] button to proceed to the next target.

Setting of the configuration file name is the end of the emulator settings.

Click the [Finish] button to display the [Summary] dialog box. Pressing the [OK] button activates the High-performance Embedded Workshop.

5. After the High-performance Embedded Workshop has been activated, the emulator is automatically connected. The message “Connected” is displayed on the [Debug] tab in the [Output] window to indicate the completion of connection.

4.1.2 Creating a New Workspace (Toolchain Used)

1. In the [Welcome!] dialog box that is displayed when the High-performance Embedded Workshop is activated, select [Create a new project workspace] radio button and click the [OK] button.

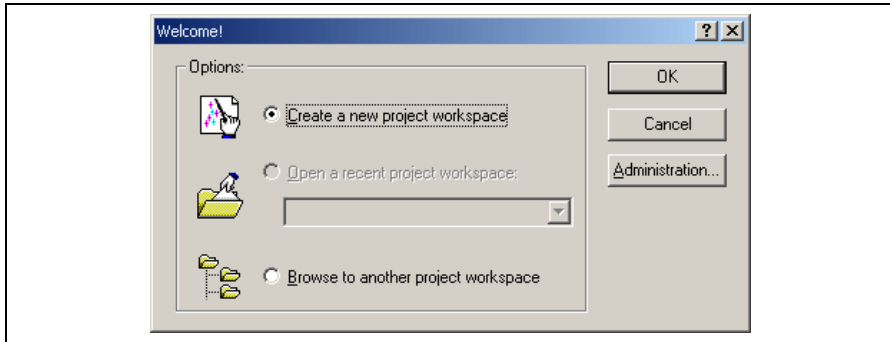

Figure 4.6 [Welcome!] Dialog Box

2. Creation of a new workspace is started. The following dialog box is displayed.

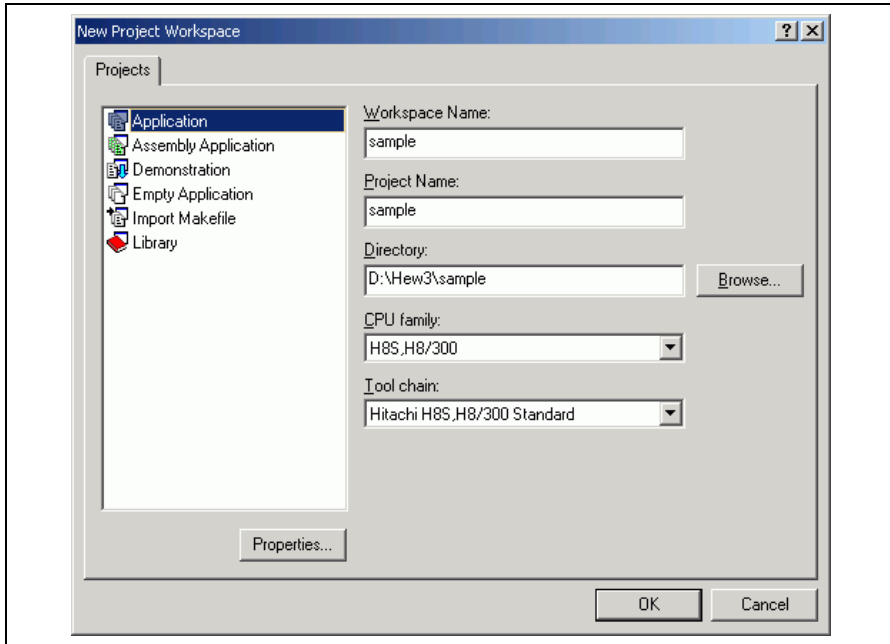

Figure 4.7 [New Project Workspace] Dialog Box

[Workspace Name] edit box: Enter the new workspace name. Here, enter 'test'.

[Project Name] edit box: Enter the project name. When the project name is the same as the workspace name, it needs not be entered.

[Directory] edit box: Enter the directory name in which the workspace will be created. Click the [Browse...] button to select a directory.

[CPU family] combo box: Select the target CPU family.

[Tool chain] combo box: Select the target toolchain name when using the toolchain. Otherwise, select [None].

[Project type] list box: Select the project type to be used.

Notes: 1. When [Demonstration] is selected in the emulator, note the followings:

The [Demonstration] is a program for the simulator attached to the H8S, H8/300 compiler package.
To use the generated source file, delete the Printf statement in the source file.

3. Make the required setting for the toolchain. When the setting has been completed, the following dialog box is displayed.

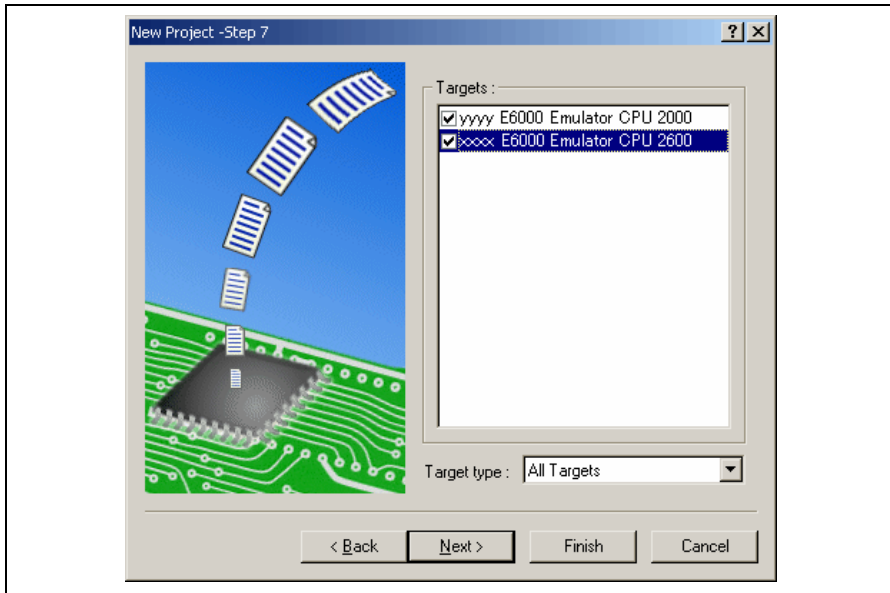

Figure 4.8 [New Project – Step 7] Dialog Box

The target platform for the session file used when the High-performance Embedded Workshop is activated must be selected here. Check the box against the target platform and then click the [Next] button. For details on the session file, refer to the High-performance Embedded Workshop user's manual.

4. Set the configuration file name.

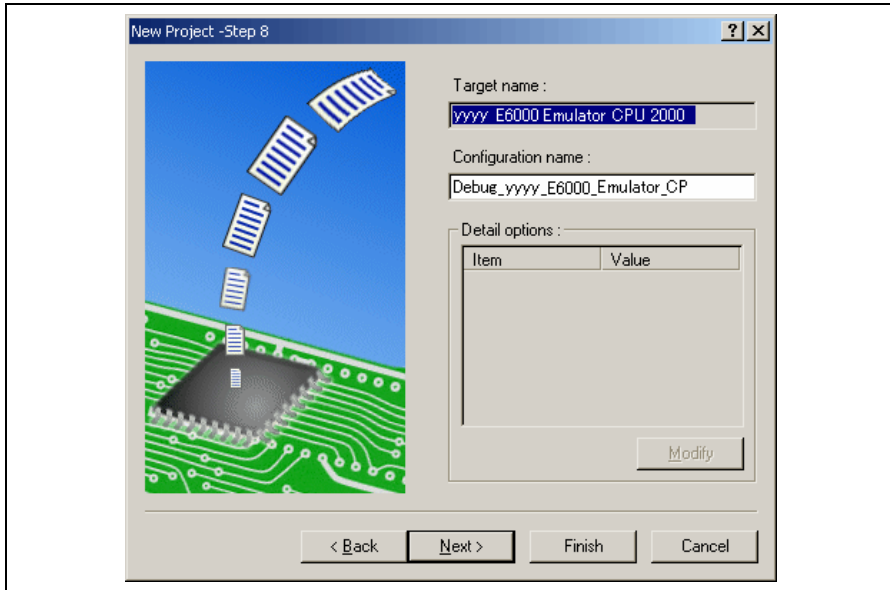

Figure 4.9 [New Project – Step 8] Dialog Box

If multiple target platforms were selected in the [New Project – Step 7] dialog box shown in figure 4.9, set the name of a configuration file for each of them, each time pressing the [Next] button to proceed to the next target.

Setting of the configuration file name is the end of the emulator settings.

Complete the creation of a new workspace according to the instructions on the screen. This activates the High-performance Embedded Workshop.

5. After the High-performance Embedded Workshop has been activated, connect the emulator. However, it is not necessary to connect the emulator immediately after the High-performance Embedded Workshop has been activated.

Select either of the following two ways to connect the emulator: connecting the emulator after the setting at emulator activation or without the setting at emulator activation. For details on the connection of the emulator, refer to section 4.2, Connecting the Emulator.

4.1.3 Selecting an Existing Workspace

1. In the [Welcome!] dialog box that is displayed when the High-performance Embedded Workshop is activated, select [Browse to another project workspace] radio button and click the [OK] button.

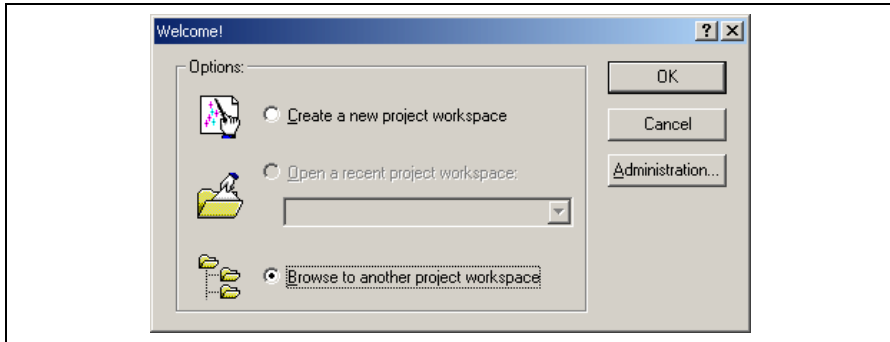

Figure 4.10 [Welcome!] Dialog Box

2. The [Open Workspace] dialog box is displayed. Select a directory in which you have created a workspace. After that, select the workspace file (.hws) and press the [Open] button.

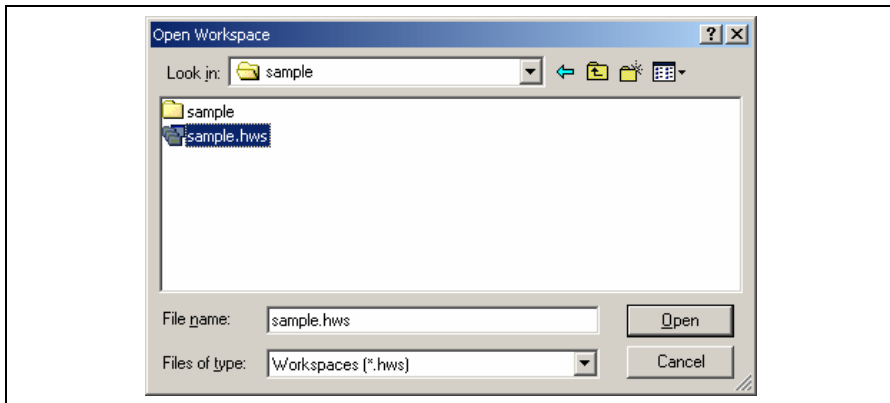

Figure 4.11 [Open Workspace] Dialog Box

3. This activates the High-performance Embedded Workshop and recovers the state of the selected workspace at the time it was saved.
When the saved state information of the selected workspace includes connection to the emulator, the emulator will automatically be connected. To connect the emulator when the saved state information does not include connection to the emulator, refer to section 4.2, Connecting the Emulator.

4.2 Connecting the Emulator

Select either of the following two ways to connect the emulator:

(a) Connecting the emulator after the setting at emulator activation

Select [Debug -> Debug Settings...] to open the [Debug Settings] dialog box. It is possible to register the download module or the command chain that is automatically executed at activation.

When the dialog box is closed after setting the [Debug Settings] dialog box, the emulator will automatically be connected.

(b) Connecting the emulator without the setting at emulator activation

Connect the emulator by simply switching the session file to one in which the setting for the emulator use has been registered.

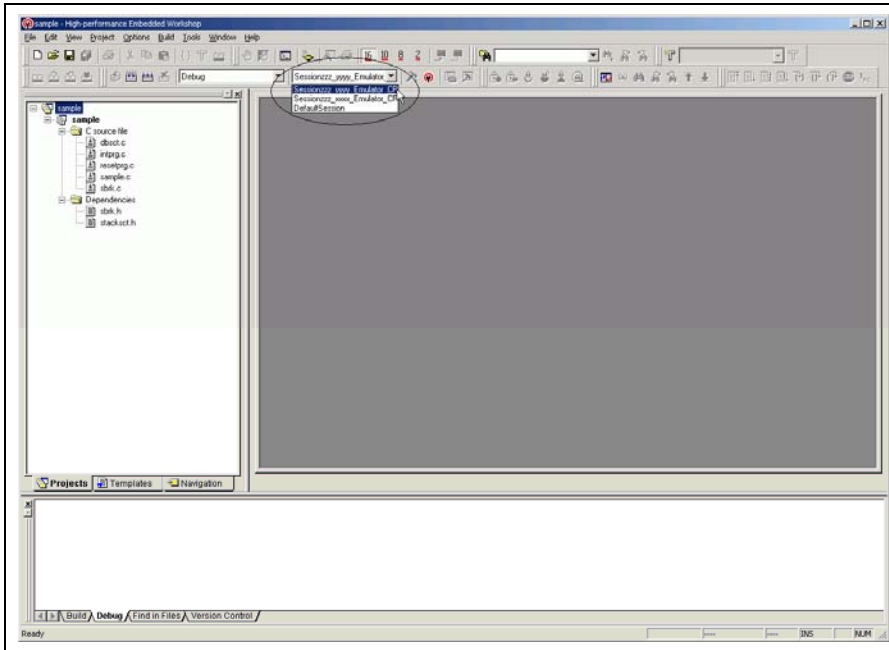



Figure 4.12 Selecting the Session File

In the list box that is circled in figure 4.12, select the session name including the character string that has been set in the [Target name] text box in figure 4.9, [New Project – Step 8] dialog box. The setting for using the emulator has been registered in this session file.

After the session name is selected, the emulator will automatically be connected. For details on the session file, refer to the High-performance Embedded Workshop user's manual.

4.3 Reconnecting the Emulator

When the emulator is disconnected, use the following way for reconnection:

Select [Debug -> Connect] or click the [Connect] toolbar button (). The emulator is connected.

Note: Before reconnecting the emulator, a load module must be registered to the High-performance Embedded Workshop.

4.4 Ending the Emulator

When using the toolchain, the emulator can be exited by using the following two methods:

- Canceling the connection of the emulator being activated
- Exiting the High-performance Embedded Workshop

(1) Canceling the connection of the emulator being activated

Select [Debug -> Disconnect] or click the [Disconnect] toolbar button ().

(2) Exiting the High-performance Embedded Workshop

Select [File -> Exit].

A message box is displayed. If necessary, click the [Yes] button to save a session. After saving a session, the High-performance Embedded Workshop exits. If not necessary, click the [No] button to exit the High-performance Embedded Workshop.

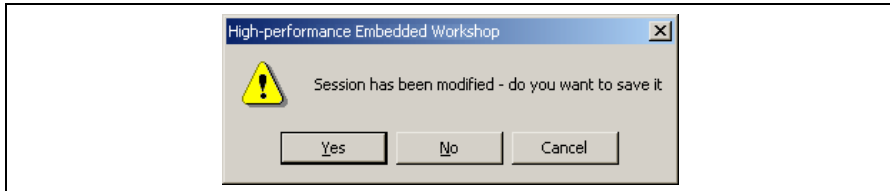

Figure 4.13 [Session has been modified] Message Box

Section 5 Debugging

This section describes the debugging operations and their related windows and dialog boxes.

Refer to the High-performance Embedded Workshop user's manual about High-performance Embedded Workshop common functions as below.

- Preparations for Debugging
- Viewing a Program
- Operating Memory
- Displaying Memory Contents as Waveforms
- Displaying Memory Contents as an Image
- Modifying the variables
- Viewing the I/O Memory
- Looking at Registers
- Executing Your Program
- Viewing the Function Call History
- Debugging with the Command Line Interface
- Elf/Dwarf2 Support
- Looking at Labels

5.1 Setting the Environment for Emulation

5.1.1 Opening the [Configuration Properties] Dialog Box

Selecting [Setup -> Emulator -> System...] or clicking the [Emulator System] toolbar button () opens the Configuration Properties] dialog box.

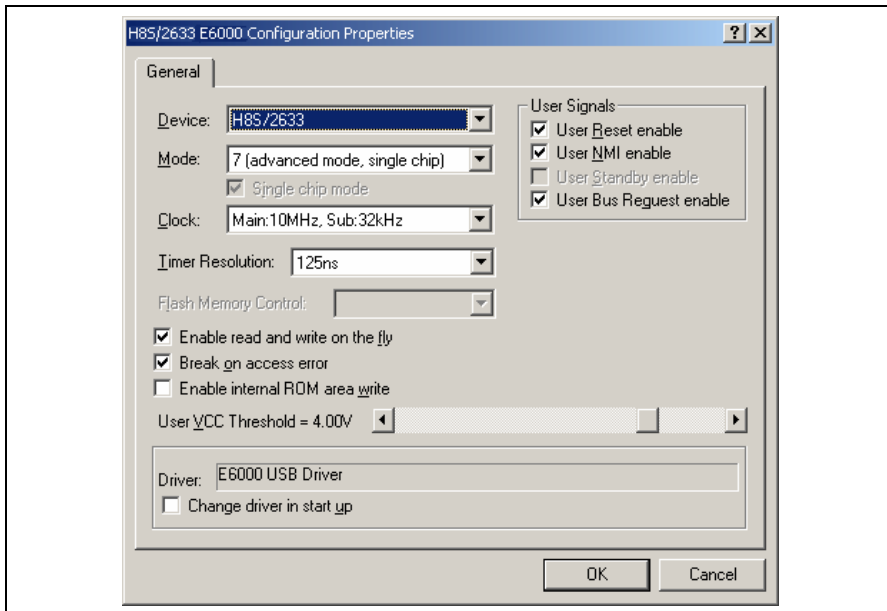

Figure 5.1 [Configuration Properties] Dialog Box ([General] Page)

This dialog allows the user to set conditions for the target MCU before downloading a program to the emulator.

[General] page

[Device]	Selects the MCU to be emulated. To use an MCU not included in the list, select CUSTOM to specify the functions required for this MCU. See the hardware manual for details.
[Mode]	Selects the MCU's operating mode.
[Clock]	Selects the speed of the MCU's clock and sub-clock.
[Timer Resolution]	Selects the resolution of the timer for use in execution time measurement. The value 20 ns, 125 ns, 250 ns, 500 ns, 1 us, 2 us, 4 us, 8 us, or 16 us can be selected. The timer for execution time measurement has a 40-bit counter. At 20 ns the maximum time that can be measured is about six hours, and at 16 μ s the maximum time is about 200 days. When the counter overflows, the maximum time possible for measurement will be displayed with prompt ">" that indicates that the counter has overflowed.
[Enable read and write on the fly]	When this box is checked, it is possible to access the target system memory while the user program is running. Do not check this check box if you require realtime emulation.
[Break on access error]	When this box is checked, a break (the user program stops) occurs if your program accesses a guarded memory area or writes to a write-protected area.
[Enable internal ROM area write]	When this box is checked, writing to the internal ROM area is enabled. For the result of writing, see the [Extended Monitor] window.
[User VCC Threshold]	Sets the voltage level for the user system.
[User Signals]	When this box is checked, the reset, NMI, standby, and bus request signals from the user system are enabled.
[Driver]	Displays the E6000 driver that is currently installed.
[Change driver in start up]	When this box is checked, selection of a driver will be available next time the emulator is connected.

Note: The items that can be set in this dialog box vary according to the emulator in use. For details, refer to section 8, Software Specifications Specific to This Product, or the online help.

5.1.2 Selecting an MCU Not Included in the List

Selecting [Custom] in [Device] of the [Configuration Properties] dialog box adds the [Custom Device] page to the dialog box.

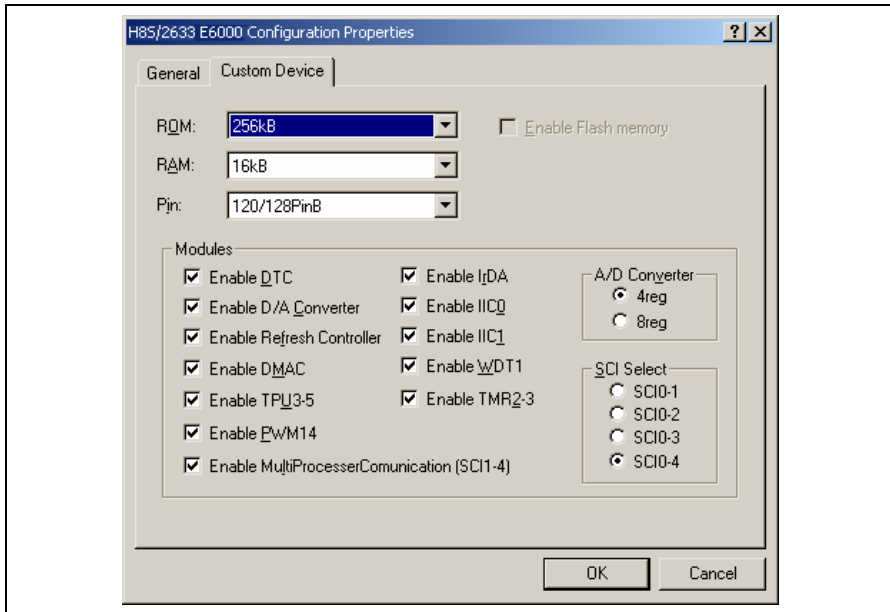

Figure 5.2 [Configuration Properties] Dialog Box ([Custom Device] Page)

Use this page to specify functions for an MCU not included in the list of MCUs. The items are adopted by the device last selected.

[Custom Device] page

[ROM]	Specify the internal ROM area size.
[RAM]	Specify the internal RAM area size.
[Pin]	Specify the product package.
[Modules]	Check this box to validate on-chip peripherals.

Note: The items that can be set in this dialog box vary according to the emulator in use. Some emulators may not support the [Custom Device] function. For details, refer to section 8, Software Specifications Specific to This Product, or the online help.

5.1.3 Selecting the Interface to be Connected

Checking [Change driver in start up] on the [Configuration Properties] dialog box allows a selection of the driver next time the emulator is connected.

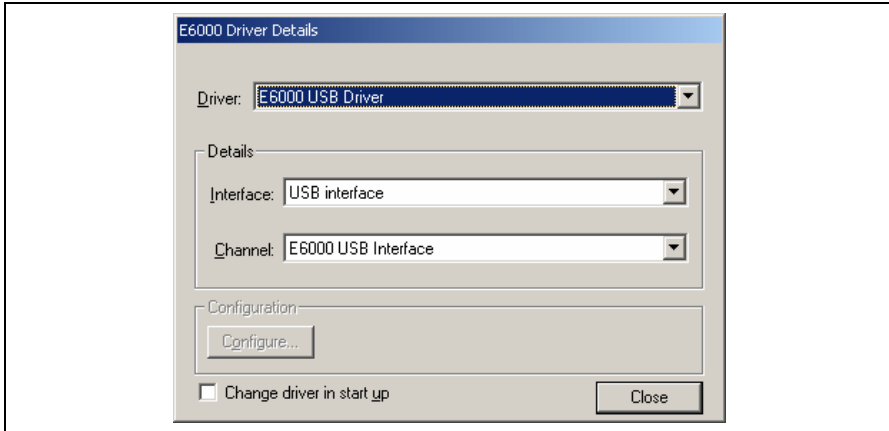

Figure 5.3 [Driver Details] Dialog Box

[Driver]: Selects the driver that connects the High-performance Embedded Workshop and the emulator.

[Details]: Sets the details of the driver being connected.

[Interface]: The name of the interface to be connected. This should not be changed in this emulator.

[Channel]: Channel for the selected interface. This should not be changed in this emulator.

[Configuration]: Driver setting.

[Configure...]: A dialog box for setting will be displayed when the driver supports the configuration dialog. Note that this item is not available with this emulator.

[Change driver in start up]: Checking this box selects the driver when the emulator is connected the next time.

5.1.4 Opening the [Memory Mapping] Dialog Box

Selecting [Setup -> Emulator -> Memory Resource...] or clicking the [Emulator Memory Resource] toolbar button () opens the [Memory Mapping] dialog box.

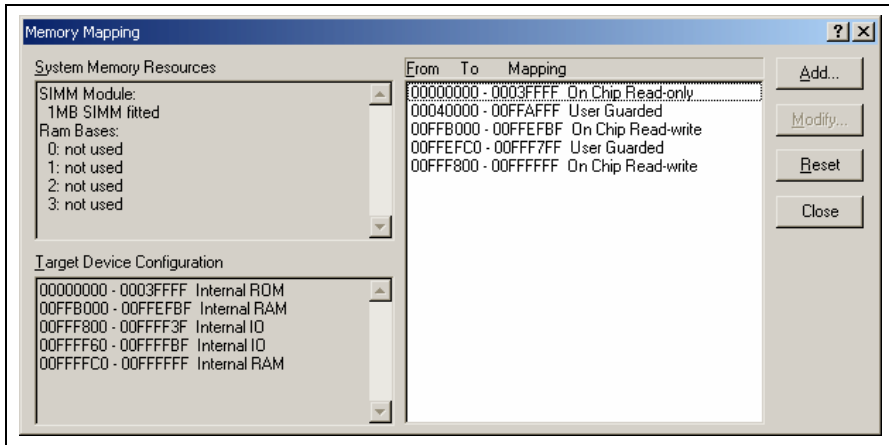

Figure 5.4 [Memory Mapping] Dialog Box

This dialog box displays the current memory map. The E6000 H8S or H8/300 series supports four blocks of user memory. These can be 256 kbyte or 1 Mbyte each, depending on the SIMM fitted. Each block can be placed in the address space on a 256-kbyte or 1-Mbyte boundary.

The memory mapping has a granularity of H'40 (D'64) byte. Each 64-byte block can be set to the internal (emulation) or external memory and can be guarded (access-prohibited), write-protected or read-write.

The H8/300 series E6000 generally incorporates an emulation memory.

In the memory map, the memory can be set as an internal (emulation) or external, guarded (access-prohibited), write-protected, or read/write in a byte unit.

[Add...]: Displays the [Edit Memory Mapping] dialog box, allowing the user to modify the address range and attributes of a memory map.

[Modify...]: Displays the [Edit Memory Mapping] dialog box, allowing the user to modify the address range and attributes of a memory map.

[Reset]: Resets the map memory to its default settings.

[Close]: Closes the dialog box.

The memory configuration of the device being emulated is displayed by the [Memory] sheet in the [Status] window.

Note: Some emulators may not support the emulation memory or the memory mapping function. For details, refer to section 8, Software Specifications Specific to This Product, or the online help.

5.1.5 Changing the Memory Map Setting

Clicking the [Add...] button on the [Memory Mapping] dialog box or clicking the [Modify...] button after selecting the information on the memory map setting you want to change opens the [Edit Memory Mapping] dialog box.

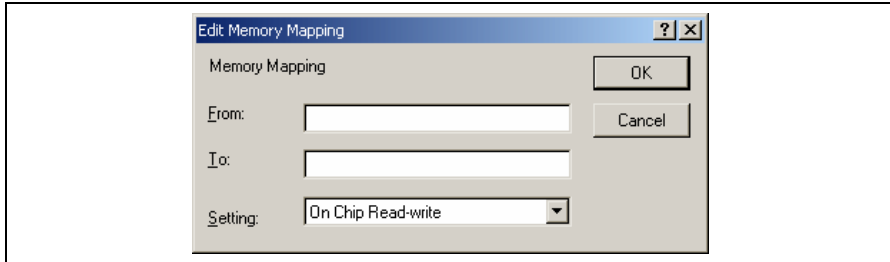

Figure 5.5 [Edit Memory Mapping] Dialog Box

Use this dialog box to change the address range and attributes of a memory map.

[From]: Enter the start address of the map range.

[To]: Enter the end address of the map range.

[Setting]: Enter the memory map setting.
The choices given are listed below. The User (external memory) and Emulator (emulation memory) attributes can be modified.

- On-chip Read-write (Cannot be changed)
- On-chip Read-only (Cannot be changed)
- On-chip Guarded (Cannot be changed)
- User Read-write (Cannot be selected when the single chip mode is selected.)
- User Read-only (Cannot be selected when the single chip mode is selected.)
- User Guarded
- Emulator Read-write
- Emulator Read-only
- Emulator Guarded

5.2 Downloading a Program

This section describes how to download a program and view it as source code or assembly-language mnemonics.

Note: After a break occurs, the High-performance Embedded Workshop displays the location of the program counter (PC) on the editor. In most cases, for example if an Elf/Dwarf2 based project is moved from its original path (at the build), the source file may not be automatically found. In this case, the High-performance Embedded Workshop will open a source file browser dialog box to allow you to manually locate the file. This path will then be used to update any other source files in this debug project.

5.2.1 Downloading a Program

A load module to be debugged must be downloaded.

To download a program, select the load module from [Debug -> Download] or select [Download] from the popup menu opened by clicking the right-hand mouse button on the load module in [Download modules] of the [Workspace] window.

Note: Before downloading a program, it must be registered to the High-performance Embedded Workshop as a load module.

5.2.2 Viewing the Source Code

To view a source file's code, double-click on its icon in the file tree, or right-click on the source file and select the [Open] option on the pop-up menu. The [Editor] window is displayed.

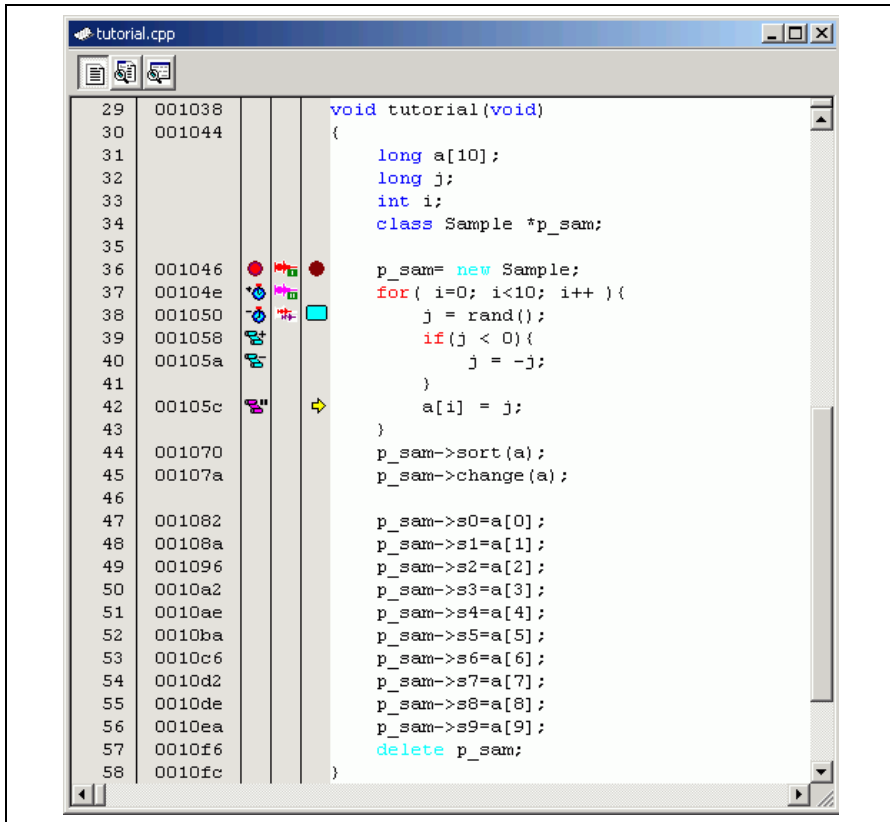

Figure 5.6 [Editor] Window

In this window, the following items are shown on the left as information on lines.

- 1st column (Line Number column): A line number for the source file
- 2nd column (Source Address column): Address information for the source line
- 3rd column (Event column): Event information (break)
- 4th column (EXT.2 Trigger column): EXT.2 Trigger information
- 5th column (S/W Breakpoints column): PC, bookmark, and breakpoint information

The text area is displayed in the right part of the [Editor] window.

Line Number column







This column displays the line number for the source file.

Source Address column

When a program is downloaded, an address for the current source file is displayed on the Source address column. These addresses are helpful when setting the PC value or a breakpoint.

Event column





The Event column displays the following items:

- : Address condition break by an event or a range channel
- : Starts time measurement by an event channel
- : Ends time measurement by an event channel
- : Starts a point-to-point range trace
- : Ends a point-to-point range trace
- : Halts trace

These are also set by using the popup menu.

EXT.2 Trigger column



The EXT.2 Trigger column displays the following items:

- : EXT.2-1 trigger condition
- : EXT.2-2 trigger condition
- : EXT.2-3 trigger condition
- : EXT.2-4 trigger condition
- : Two or more EXT.2 trigger conditions

It is also possible to set them by using the popup menu.

S/W Breakpoints column

This column displays the following items:

- : A bookmark is set.
- : A Software Break is set.
- : PC location

➡ To switch off a column in all source files

1. Right-click on the [Editor] window or select the [Edit] menu.
2. Click the [Define Column Format...] menu item.
3. The [Global Editor Column States] dialog box is displayed.
4. A check box indicates whether the column is enabled or not. If it is checked, the column is enabled. If the check box is gray, the column is enabled in some files and disabled in others. Deselect the check box of a column you want to switch off.
5. Click the [OK] button for the new column settings to take effect.

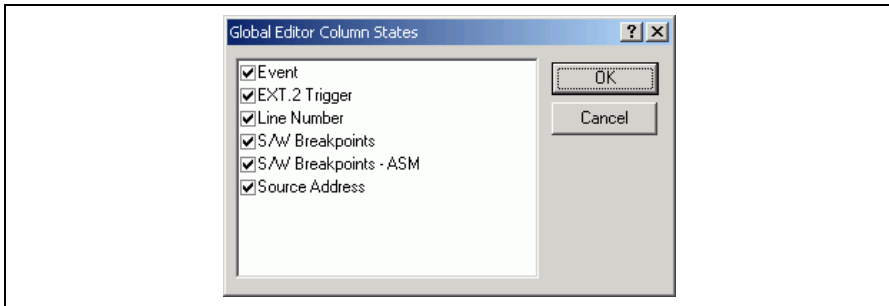

Figure 5.7 [Global Editor Column States] Dialog Box

➡ To switch off a column in one source file

1. Click the right-hand mouse button on the [Editor] window which contains the column you want to remove to display the popup menu.
2. Click the [Columns] menu item to display a cascaded menu item. The columns are displayed in this popup menu. If a column is enabled, it has a tick mark next to its name. Clicking the entry will toggle whether the column is displayed or not.

5.2.3 Viewing the Assembly-Language Code

If you have a source file open, right-click to open the pop-up menu and select the [View Disassembly] option to open a Disassembly view at the same address as the current Source view.

It is also possible to view the disassembly using the new integrated [Disassembly view] in the source file.

If you do not have a source file, but wish to view code at assembly-language level, then select one of the following operations:

- Click on the View Disassembly toolbar button ().
- Choose the [View -> Disassembly...] menu option.
- Press Ctrl + D.

The [Disassembly] window opens at the current PC location.

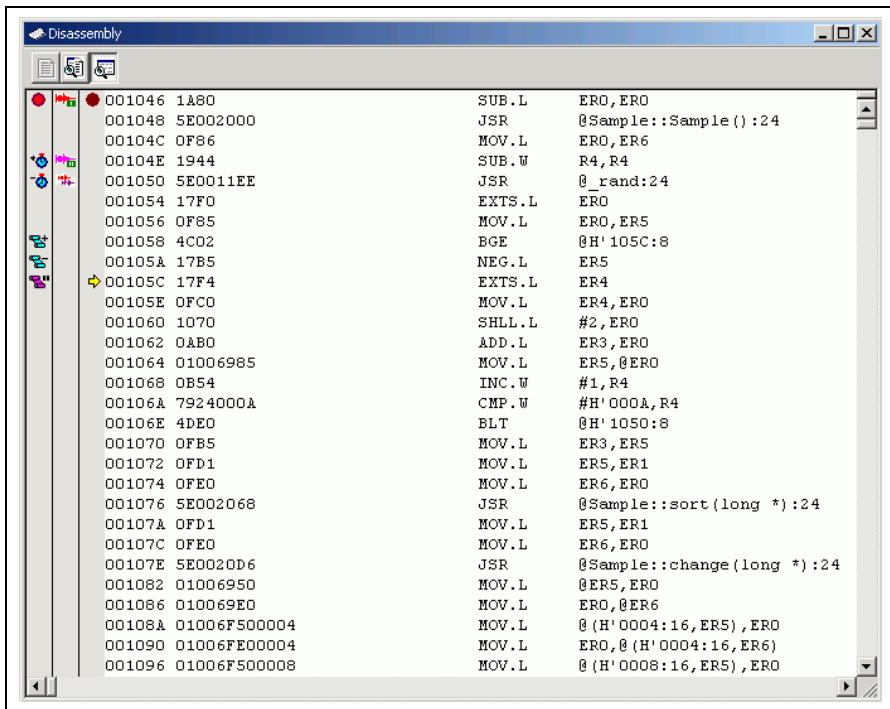

Figure 5.8 [Disassembly] Window

In this window, the following information is shown on the left as information lines.

- 1st column (Event column): Event information (break)
- 2nd column (EXT.2 Trigger column): EXT.2 Trigger information
- 3rd column (S/W Breakpoints - ASM column): PC and breakpoint information

This window is used in the same way as the source code window.

5.2.4 Modifying the Assembly-Language Code

You can modify the assembly-language code by double-clicking on the instruction that you want to change. The [Assembler] dialog box will be opened.

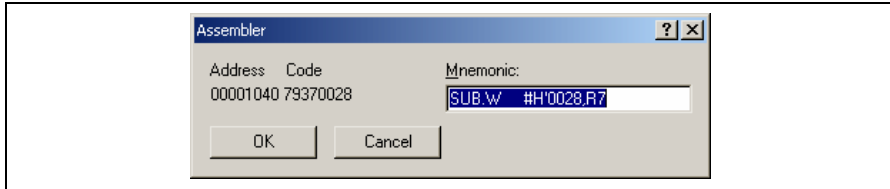

Figure 5.9 [Assembler] Dialog Box

The address, instruction code, and mnemonic are displayed. Enter the new instruction or edit the old instruction in the [Mnemonics] field. Pressing the [Enter] key will replace the memory content with the new instruction and move on to the next instruction. Clicking the [OK] button will replace the memory content with the new instruction and close the dialog box. Clicking the [Cancel] button or pressing the [Esc] key will close the dialog box without modifying the memory contents.

Note: The assembly-language code being displayed is the current memory content. If the memory contents are changed the [Assembler] dialog box and the [Disassembly] window will show the new assembly-language code, but the source file displayed in the [Editor] window will be unchanged. This is the same even if the source file contains an assembler.

5.2.5 Viewing a Specific Address

When you are viewing your program in the [Disassembly] window, you may wish to look at another area of your program's code. Rather than scrolling through a lot of code in the program, you can go directly to a specific address. Select [Set Address...] from the popup menu, and the dialog box shown in figure 5.10 is displayed.

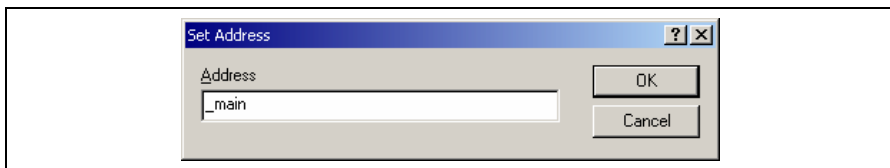



Figure 5.10 [Set Address] Dialog Box

Enter the address in the [Address] edit box and either click on the [OK] button or press the Enter key. A label name can also be specified as the address. The [Disassembly] window will be updated to show the code at the new address. When an overloaded function or a class name is entered, the [Select Function] dialog box opens for you to select a function.

5.2.6 Viewing the Current Program Counter Address

Wherever you can enter an address or value into the High-performance Embedded Workshop, you can also enter an expression. If you enter a register name prefixed by the # character, the contents of that register will be used as the value in the expression. Therefore, if you open the [Set Address] dialog box and enter the expression #pc, the [Editor] or [Disassembly] window will display the current PC address. It also allows the offset of the current PC to be displayed by entering an expression with the PC register plus an offset, e.g., #PC+0x100.

5.3 Viewing the Current Status

Choose [View -> CPU -> Status] or click the [View Status] toolbar button () to open the [Status] window and see the current status of the debugging platform.

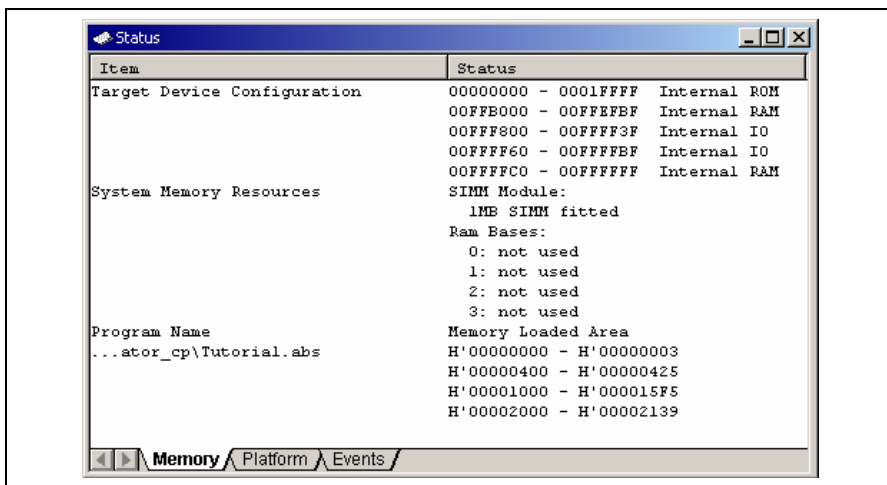

Figure 5.11 [Status] Window

The [Status] window has three sheets:

- [Memory] sheet
Contains information about the current memory status including the memory mapping resources and the areas used by the currently loaded object file.
- [Platform] sheet
Contains information about the current status of the debugging platform, typically including CPU type and mode; and run status.
- [Events] sheet
Contains information about the current event (breakpoint) status, including resource information.

Note: The items that can be set in this dialog box vary according to the emulator in use. For details, refer to section 8, Software Specifications Specific to This Product, or the online help.

5.4 Reading and Displaying the Emulator Information Regularly

Use the [Extended Monitor] window to know the changing information on the emulator no matter the user program is running or halted.

Note: The Extended Monitor function does not affect the execution of the user program since it monitors the user system or the signal output from the MCU in the emulator by using the emulator's hardware circuit.

5.4.1 Opening the [Extended Monitor] Window

Selecting [View -> CPU -> Extended Monitor] or clicking the [Extended Monitor] toolbar button  displays this window. The interval of updating the display is approximately 100 ms during user program execution or 1,000 ms while breaking, respectively.

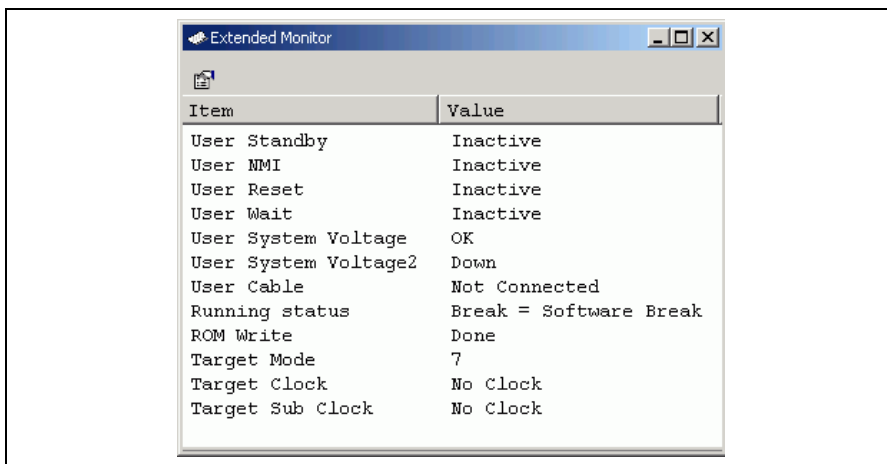

Figure 5.12 [Extended Monitor] Window

5.4.2 Selecting Items to be Displayed

Selecting [Properties...] from the popup menu displays the [Extended Monitor Configuration] dialog box.

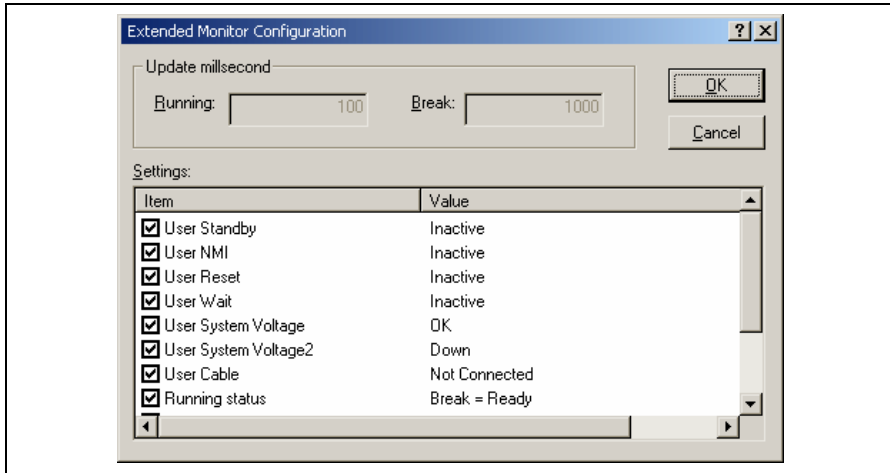

Figure 5.13 [Extended Monitor Configuration] Dialog Box

This dialog box allows the user to set the items to be displayed in the [Extended Monitor] window.

Note: The items that can be set in this dialog box vary according to the emulator in use. For details, refer to section 8, Software Specifications Specific to This Product, or the online help.

5.5 Displaying Memory Contents in Realtime

Use the [Monitor] window to monitor the memory contents during user program execution. In the Monitor function, the realtime operation is retained since the bus monitoring circuit of the emulator sets the read/write signal of the MCU as a trigger and holds the address bus and data bus values to update the displayed contents of the memory.

Up to eight points can be set by using the eight monitoring channels on the bus monitoring circuit. 1 to 256 bytes can be monitored at one point. It is possible that a part or all of monitoring ranges is overlapped.

Note: Monitoring is impossible for an area, such as an internal timer counter, where no internal read/write signal is generated to update a value.

5.5.1 Opening the [Monitor] Window

To open the [Monitor] window, select [View -> CPU -> Monitor -> Monitor Setting...], or click the [Monitor] toolbar button () to display the [Monitor Settings] dialog box.

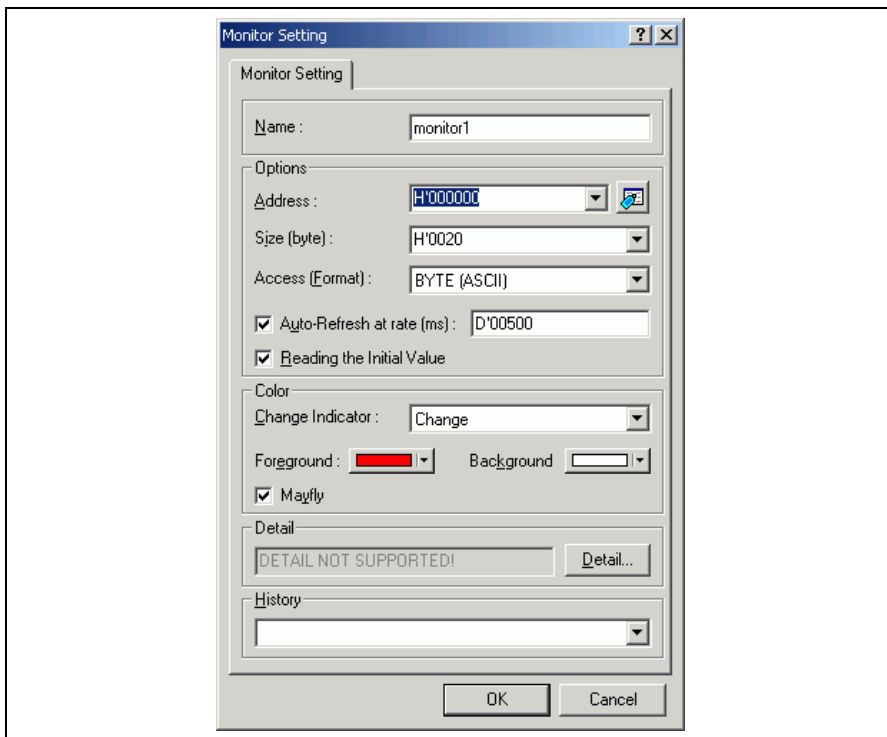

Figure 5.14 [Monitor Setting] Dialog Box

- [Name]: Decides the name of the monitor window.
- [Options]: Sets monitor conditions.
- [Address]: Sets the start address for monitoring.
- [Size]: Sets the range for monitoring.
- [Access]: Sets the access size to be displayed in the monitor window.
- [Auto-Refresh at rate (ms)]: Sets the interval for acquisition by monitoring (500 ms at minimum).
- [Reading the Initial Value]: Selects reading of the values in the monitored area when the monitor window is opened.
- [Color]: Sets the method to update monitoring and the attribute of colors.
- [Change Indicator]: Selects how to display the values that have changed during monitoring (available when [Reading the Initial Value] has been selected).
- No change:** No color change.
- Change:** Color is changed according to the [Foreground] and [Background] options.
- Gray:** Those data with values that have not been changed are displayed in gray.
- Appear:** A value is only displayed after changed.
- [Foreground]: Sets the color used for display (available when [Change] has been selected).
- [Background]: Sets the background color (available when [Change] has been selected).
- [Mayfly]: A check in this box selects restoration of the color of those data which have not been updated in a specified interval to the color selected in the [Background] option. The specified interval is the interval for monitor acquisition (available when [Change], [Gray], or [Appear] has been selected).
- [Detail]: Sets the items specific to the emulator. Not used with this emulator.
- [History]: Displays the previous settings.

- Notes: 1. In this emulator, odd addressees cannot be specified as the start addresses for monitoring.
2. Selection of the foreground or background color may not be available depending on the operating system in use.

After setting, clicking the [OK] button displays the [Monitor] window.

Address	+0	+1	+2	+3	+4	+5	+6	+7	+8	+9	+A	+B	+C	+D	+E	+F
FFEF80	00	00	13	72	00	00	28	47	00	00	2C	67	00	00	33	59
FFEF90	00	00	42	87	00	00	4D	AA	00	00	50	0F	00	00	64	88
FFEFA0	00	00	69	56	00	00	75	66	00	02	12	24	00	00	AA	AA
FFEFB0	57	70	00	00	00	01	80	74	00	00	10	36	00	00	04	1E
FFEFC0	6A	18	6A	18	6A	18	6A	18	6A	18	6A	18	6A	18	6A	18

Figure 5.15 [Monitor] Window

During user program execution, the display is updated according to the setting value of the auto-update interval.

Note: Select [Refresh] from the popup menu when data is not displayed correctly after changing the address or content of memory.

5.5.2 Changing the Monitor Settings

Selecting [Monitor Setting...] from the popup menu of the [Monitor] window displays the [Monitor Setting] dialog box, which allows the settings to be changed.

Colors, the size of accesses, and the display format can be easily changed from [Color] or [Access] of the popup menu.

5.5.3 Temporarily Stopping Update of the Monitor

During user program execution, the display of the [Monitor] window is automatically updated according to the auto-update interval. Select [Lock Refresh] from the popup menu of the [Monitor] window to stop the update of display. The characters in the address section are displayed in black, and the update of display is stopped.

Selecting [Lock Refresh] again from the popup menu cancels the stopped state.

5.5.4 Deleting the Monitor Settings

Selecting [Close] from the popup menu of the [Monitor] window to be deleted closes the [Monitor] window and deletes the monitor settings.

5.5.5 Monitoring Variables

Using the [Watch] window refers to the value of any variables.

When the address of the variable registered in the [Watch] window exists within the monitoring range that has been set by the Monitor function, the value of the variable can be updated and displayed.

This function allows checking the content of a variable without affecting the realtime operation.

5.5.6 Hiding the [Monitor] Window

When using the Monitor function to monitor the value of a variable from the [Watch] window, hide the [Monitor] window for the effective use of the screen.

The current monitoring information is listed as the submenu when selecting [Display -> CPU -> Monitor]. The list consists of the [Monitor] window name and the address to start monitoring.

When the left of the list is checked, the [Monitor] window is being displayed.

Selecting items of the [Monitor] window you want to hide from the monitor setting list displays no [Monitor] window and removes the check mark at the left of the list.

To display the [Monitor] window again, select the hidden the [Monitor] window.

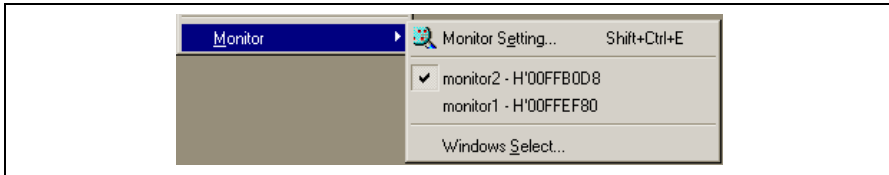

Figure 5.16 Monitor Setting List

5.5.7 Managing the [Monitor] Window

Selecting [Display -> CPU -> Monitor -> Windows Select...] displays the [Windows Select] dialog box. In this window, the current monitoring condition is checked and the new monitoring condition is added, edited, and deleted in succession.

Selecting multiple monitoring conditions enables a temporary stop of update, hiding, and deletion.

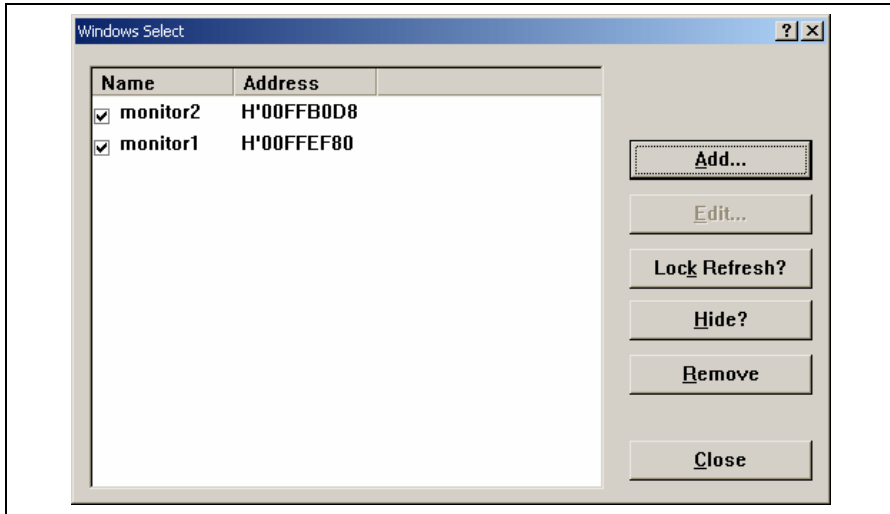

Figure 5.17 Selection in the [Monitor] Window

[Add]: Adds a new monitoring condition.

[Edit]: Changes the settings of the selected [Monitor] window (disabled when selecting multiple items).

[Lock Refresh/Unlock Refresh]: Automatically updates or stops updating the display of the selected [Monitor] window.

[Hide/UnHide]: Displays or hides the selected [Monitor] window.

[Remove]: Removes the selected monitoring conditions.

[Close]: Closes this dialog box.

5.6 Viewing the Variables

This section describes how you can look at variables in the source program.

5.6.1 [Watch] Window

You can view any value in the [Watch] window.

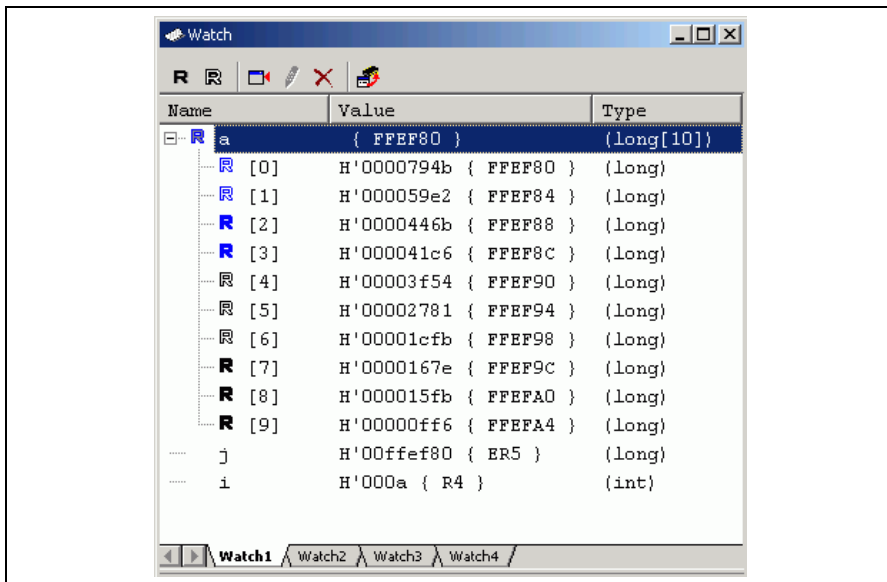

Figure 5.18 [Watch] Window

The [R] mark shows that the value of the variable can be updated during user program execution.

For updating of the content of the variable that has been registered in the [Watch] window, there are the following three methods:

1. Use the Monitor function without halting the user program

The read/write signal of the MCU is set as a trigger and holds the address bus and data bus values to update the value of the variable.

Note: Although the realtime operation is retained, the size and number points to be monitored are limited. For the Monitor function, refer to section 5.5, Displaying Memory Contents in Realtime.

2. Read the memory content directly from the High-performance Embedded Workshop to update the values without halting the user program since the bus mastership is owned by the emulator

Note: While the emulator reserves the bus mastership, the realtime operation is disabled because the CPU stops operation. This method is only available for accessing the internal ROM, internal RAM, and emulation memory.

The area used here or this method may not be available depending on the emulator in use. For details, refer to section 8, Software Specifications Specific to This Product, or [Enable read and write on the fly] on the [General] page of the [Configuration Properties] dialog box in the online help.

3. Temporarily stops the user program and reads the memory contents

Note: The realtime operation is disabled because the user program is stopped temporarily. This method is only available for accessing the areas (internal I/O, DTCRAM, and user memory) other than those in item 2 mentioned above.

It is possible to recognize the method for updating the value during user program execution according to the color of the [R] mark.

Blue-outline [R]: The variable's address is within the range that has been set for the monitoring function and the data is readable by using the monitoring function.

Blue [R]: An updated value of the data at this location has been read by the monitoring function.

Black-outline [R]: The variable's address is outside the range that has been set for the monitoring function and the data is not readable by using the monitoring function.

Black [R]: A value has been updated by reading the normal data.

- Notes:
1. This function can be set per variable or per element or body for structures of data.
 2. The color of an [R] in the [Name] column changes according to the trace and monitoring settings.
 3. A variable that is allocated to a register cannot be selected for monitoring.

5.7 Using the Event Points

The emulator has the event point function that performs breaking, tracing, and execution time measurement by specifying higher-level conditions along with the software breakpoints standard for the High-performance Embedded Workshop.

5.7.1 Software Breakpoints

When the instruction of the specified address is fetched, the user program is stopped. Up to 256 points can be set.

Note that, however, only one software breakpoint can be set in the ROM area of the user system. This particular breakpoint is called the on-chip breakpoint, which stops the user program after executing the instruction of the specified address.

When it is necessary to set two or more software breakpoints to the external ROM area of the user system, allocate this area to the emulation memory, copy the code, and then set the software breakpoints.

5.7.2 Event Points

Event points can be used for higher-level conditions such as the data condition as well as specification of the single address. Up to 12 event points can be set by using event channels and range channels in the event detection system.

When the condition is satisfied, event points are also used as the start/end conditions for execution time measurement or trace acquisition in addition to halting the user program. Several event points can be used to set more complex conditions.

Note: Event points acquire the data, test conditions, and execute an action (such as halting the user program) by the hardware circuit of the emulator. Therefore, a delay of several cycles will occur from the satisfaction of the condition to the execution of an action.

5.7.3 Event Detection System

In addition to the 4 range channels, the emulator also has 8 event channels. The event channels have more functions (such as sequencing or counting) than the range channels.

Event Channels (Ch1 to Ch8):

The emulator has 8 event channels. The event channel can be defined as a combination of one or more of the followings:

- An address or an address range
- Outside of an address range
- A read, a write, or either
- Data with a mask specification
- Bus state
- Area
- The value of four external probe signals
- The number of times the event has occurred
- The number of delay cycles after the event has occurred

A maximum of eight points can be used as a combination in a sequence. The program is activated or halted by an occurrence of the previous event in each sequence.

Range Channels (Ch9 to Ch12):

The emulator has 4 range channels. The range channel can be defined as a combination of one or more of the followings:

- An address or an address range
- Outside of an address range
- A read, a write, or either
- Data with a mask specification
- Bus state
- Area
- The value of four external probe signals
- The number of delay cycles after the event has occurred

5.7.4 Signals to Indicate Bus States and Areas

In the event detection system, signals indicating the MCU's bus states and the accessed areas can be specified as the event detection condition.

These signals are output from the MCU on the emulator; the signals to be acquired will vary according to the emulator in use.

The signals to indicate bus states and areas are used to set the [Bus/Area] condition of the event point. They can also be acquired as the trace information.

The bus state signals are also used to set the condition not to acquire the trace ([Suppress] option) and in the Access Count Of Specified Range Measurement mode for measuring the hardware performance ([Access Type] option).

For the trace function, refer to section 5.8, Viewing the Trace Information. For the hardware performance function, refer to section 5.9, Analyzing Performance.

The following tables show examples of signals to indicate the bus states and areas that can be acquired by the emulator.

Table 5.1 Bus State Signals Acquired by the Emulator

Bus State	Trace Display (Status)	Description
CPU Prefetch	PROG	CPU prefetch cycles
CPU Data	DATA	CPU data access cycles
Refresh	REFRESH	Refresh cycles
DMAC	DMAC	DMAC cycles
DTC	DTC	DTC cycles
Other	OTHER	Others

Table 5.2 Area Signals Acquired by the Emulator

Area	Trace Display (Status)	Description
On-chip ROM	ROM	ROM
On-chip RAM	RAM	RAM
On-chip I/O 16bit	I/O-16	16-bit I/O
On-chip I/O 8bit	I/O-8	8-bit I/O
External I/O 16bit	EXT-16	16-bit EXT (external)
External I/O 8bit	EXT-8	8-bit EXT (external)
DTC RAM	RAM/DTC	DTCRAM

Note: The signals to indicate the bus states and areas vary according to the emulator in use. For details, refer to section 8, Software Specifications Specific to This Product, or the online help.

5.7.5 Opening the [Event] Window

Select [View -> Code -> Eventpoints] or click the [Eventpoints] toolbar button  to open the [Event] window.

The [Event] window has the following three sheets:

[Breakpoint] sheet: Displays the settings made for software breakpoints. It is also possible to set, modify, and cancel software breakpoints.

[Event] sheet: Displays or sets event points.

[Trigger] sheet: Displays or sets trigger points.

5.7.6 Setting Software Breakpoints

It is possible to display, modify, and add software breakpoints on the [Breakpoint] sheet.

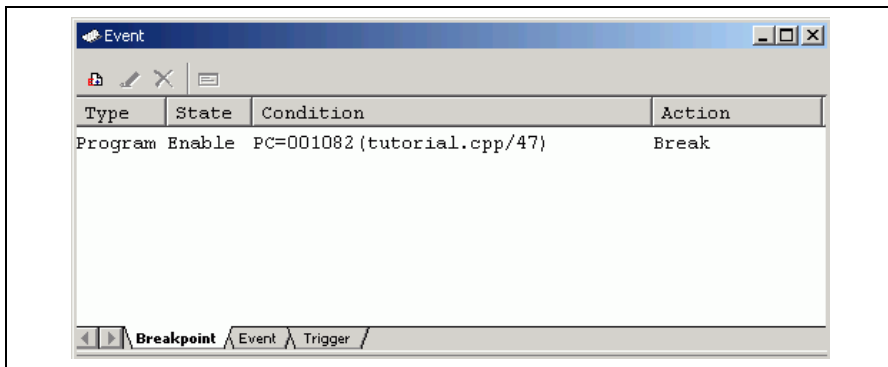

Figure 5.19 [Event] Window ([Breakpoint] Sheet)

Select [Add...] or the software breakpoint displayed in this window and then select [Edit...] from the popup menu to display the [Breakpoint/Event Properties] dialog box.

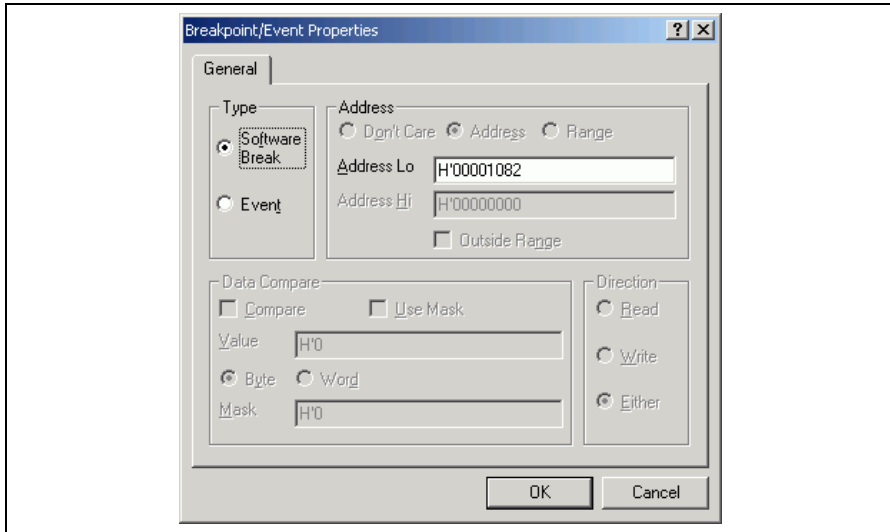

Figure 5.20 [Breakpoint/Event Properties] Dialog Box (Setting a Software Break)

In this dialog box, select the address condition to set software breakpoints.

[Type]: Select the type of a breakpoint. Note that the [Breakpoint/Event Properties] dialog box is used for setting software breakpoints and event points. Selecting a particular type of breakpoint enables or disables other pages and parts of the dialog according to the options available to that type of breakpoint.

[Software Break]: Only a single address with a program fetch can be selected. Other options are invalid.

[Event]: Set conditions in detail with other options on this page, or on the [Bus/Area], [Signals], or [Action] page.

[Address]: Set address conditions.

[Address Lo]: Select a single address where a software breakpoint will be set.

5.7.7 Setting Event Points

On the [Event] sheet, the settings for event points are displayed, modified, and added.

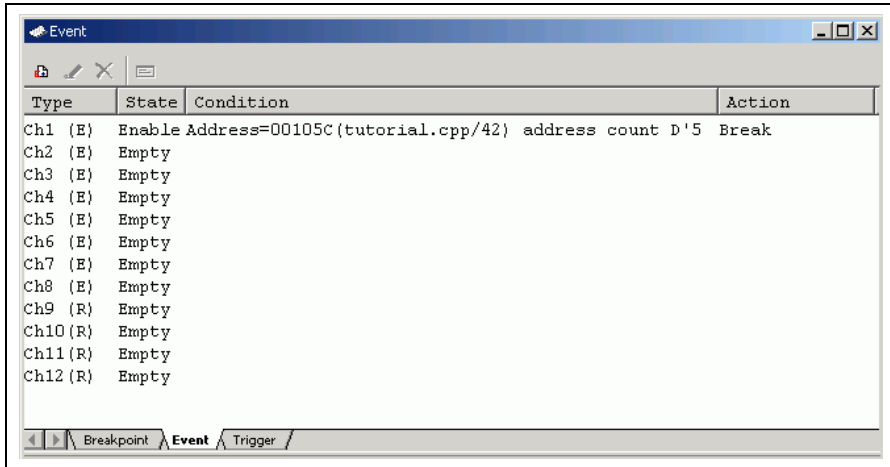

Figure 5.21 [Event] Window ([Event] Sheet)

Select [Add...] or the event point displayed in this window and then select [Edit...] from the popup menu to display the [Breakpoint/Event Properties] dialog box.

The conditions for the event point are set on the [General], [Bus/Area], [Signals], and [Action] pages. The search condition for the event point is set by multiple conditions set on these pages.

- Notes:
1. Channel 8 has the trigger output function. When the condition on channel 8 is satisfied, the low-level signal will be output from the external probe 1 (EXT1) for a bus cycle.
 2. When the event point is used as the condition for acquiring the trace information, select [Trace Acquisition...] from the popup menu. For the trace function, refer to section 5.8, Viewing Trace Information.
 3. If a condition that is unavailable for a range channel is set in editing of the range channels (Ch9 to Ch12), the selected channel is automatically replaced by an unused event channel (Ch1 to Ch8).

Table 5.3 Conditions Unavailable for a Range Channel

Condition	Related Options
Selecting outside the specified address range	[Outside Range] on the [General] page
Selecting the start or end of the execution time measurement	[Start Timer] and [Stop Timer] on the [Action] page
Specifying the count when an event occurs (twice or more)	[Required number of event occurrences] on the [Action] page
Specifying sequencing	[Enable Sequencing] on the [Action] page

(1) [General] page

The address and data conditions are set.

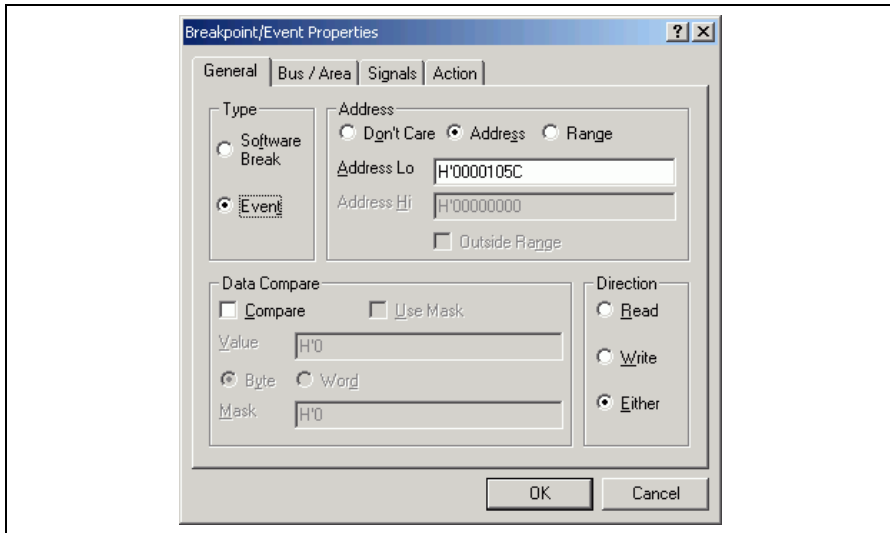

Figure 5.22 [Breakpoint/Event Properties] Dialog Box ([General] Page)

[Type]: Select the type of a breakpoint. Note that the [Breakpoint/Event Properties] dialog box is used for setting software breakpoints and event points. Selecting a particular type of breakpoint enables or disables other pages and parts of the dialog according to the options available to that type of breakpoint.

[Software Break]: Only a single address with a program fetch can be selected. Other options are invalid.

[Event]: Set conditions in detail with other options on this page, or on the [Bus/Area], [Signals], or [Action] page.

[Address]: Sets the address condition.

[Don't care]: Sets no address condition.

[Address]: Allows a single address to be selected.

[Range]: Allows an address range to be selected.

[Address Lo]: Set a single address or the start of an address range (available when [Address] or [Range] has been selected).

[Address Hi]: Set the end of an address range (available when [Range] has been selected).

[Outside Range]: Used to negate the range (i.e., the event will occur when the address is outside the range). This is available when [Address] or [Range] has been selected.

[Data Compare]: Sets the data condition.

[Compare]: Checking this box compares data.

[Use Mask]: Sets a mask condition (available when [Compare] has been selected).

[Value]: Specifies the data bus value as numerics. The size of data for access can also be selected (available when [Compare] has been selected).

[Byte]: Sets access in bytes as the condition (available when [Compare] has been selected).

[Word]: Sets access in words as the condition (available when [Compare] has been selected).

[Mask]: Sets a value to be masked. This value will be ANDed with the value of the data bus and data condition. The result will be used to compare data (available when [Use Mask] has been selected).

[Direction]: Selects a condition with read or write cycles.

[Read]: Sets read cycles as the condition.

[Write]: Sets write cycles as the condition.

[Either]: Sets either read or write cycles as the condition.

(2) [Bus/Area] page

Use this page to set the bus status and the memory area being accessed.

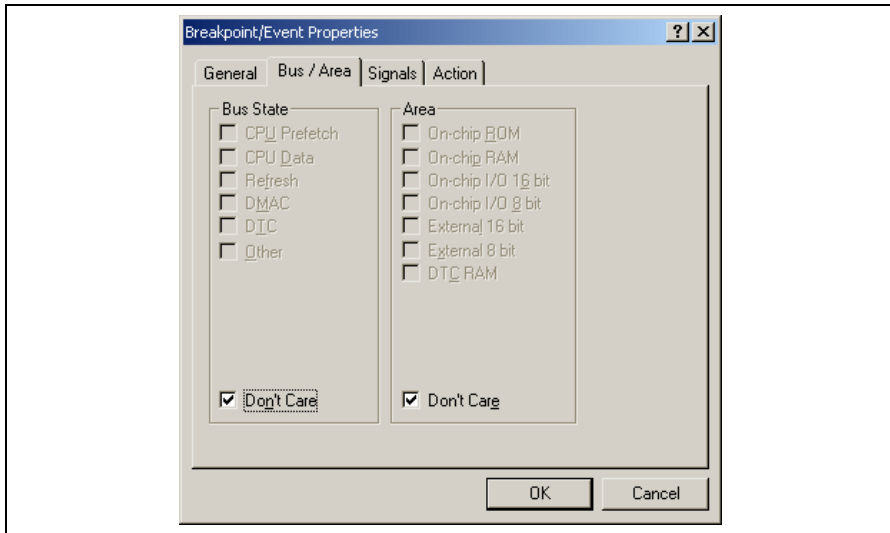

Figure 5.23 [Breakpoint/Event Properties] Dialog Box ([Bus/Area] Page)

[Bus State]: Sets the bus status as the condition. When the [Don't care] check box is checked, the event will be satisfied with any bus status.

[Area]: Specifies the area for searching. When the [Don't care] check box is checked, the event will be satisfied in any area.

Note: Items set for the bus state and memory access area vary according to the emulator in use. For details, refer to section 5.7.4, Signals to Indicate Bus States and Areas.

(3) [Signals] page

Use this page to set external signals.

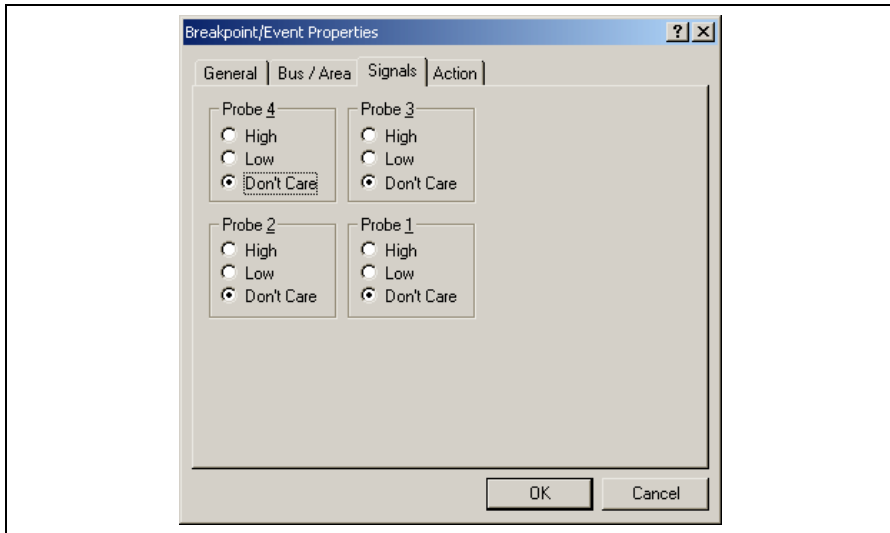

Figure 5.24 [Breakpoint/Event Properties] Dialog Box ([Signals] Page)

- [Probe4]: Detects the status of the input probe signal 4
 - [High]: Detects the high level of the input probe signal
 - [Low]: Detects the low level of the input probe signal
 - [Don't care]: The status of the input probe signal is not detected
- [Probe3]: Detects the status of the input probe signal 3
 - [High]: Detects the high level of the input probe signal
 - [Low]: Detects the low level of the input probe signal
 - [Don't care]: The status of the input probe signal is not detected
- [Probe2]: Detects the status of the input probe signal 2
 - [High]: Detects the high level of the input probe signal
 - [Low]: Detects the low level of the input probe signal
 - [Don't care]: The status of the input probe signal is not detected

- [Probe1]: Detects the status of the input probe signal 1
- [High]: Detects the high level of the input probe signal
- [Low]: Detects the low level of the input probe signal
- [Don't care]: The status of the input probe signal is not detected

(4) [Action] page

Use this page to decide what action the emulator takes when the defined event occurs.

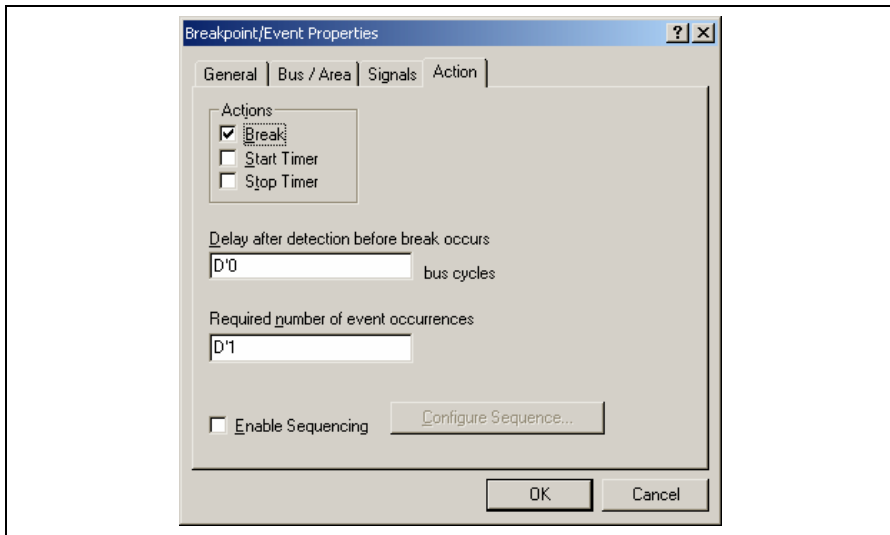

Figure 5.25 [Breakpoint/Event Properties] Dialog Box ([Action] Page)

- [Action]: Selects an action that occurs when the event is satisfied. This cannot be used for an event point being used as the trace acquisition condition.
- [Break]: Causes a break (stop) in the user program when the event occurs. This is the default action.
- [Start Timer]: Starts the run timer (the run timer value is displayed in the [Status] window).
- [Stop Timer]: Stops the run timer (the run timer value is displayed in the [Status] window).
- [Delay after detection before break occurs]: Sets a 16-bit delay (in bus cycles) after the event has occurred before the action is taken. The delay is only applicable to break events and there is only one delay counter in hardware, therefore only one breakpoint can have a non-zero delay. The range of values is D'0 to D'65,535 (only available when [Break] has been selected). This cannot be used for an event point being used as the trace acquisition condition.

[Required number of event occurrences]:

Allows a 16-bit pass count to be set. The event must occur the specified number of times before the action is taken. The range of values is D'0 to D'65,535.

[Enable Sequencing]: Allows the event to take part in a sequence of events (setting this requires the event to use an event detector).

[Configure Sequence...]: Displays the [Event Sequencing] dialog box to allow the event sequencing to be configured (only available when [Enable Sequencing] has been selected).

(5) [Event Sequencing] dialog box

This dialog box allows the user to define which events are triggered by other events. If this dialog box is accessed (directly or indirectly) from [Trace Acquisition...], only those events assigned to the trace subsystem are displayed. If accessed from the [Eventpoint] window, only the breakpoint or timer events are shown.

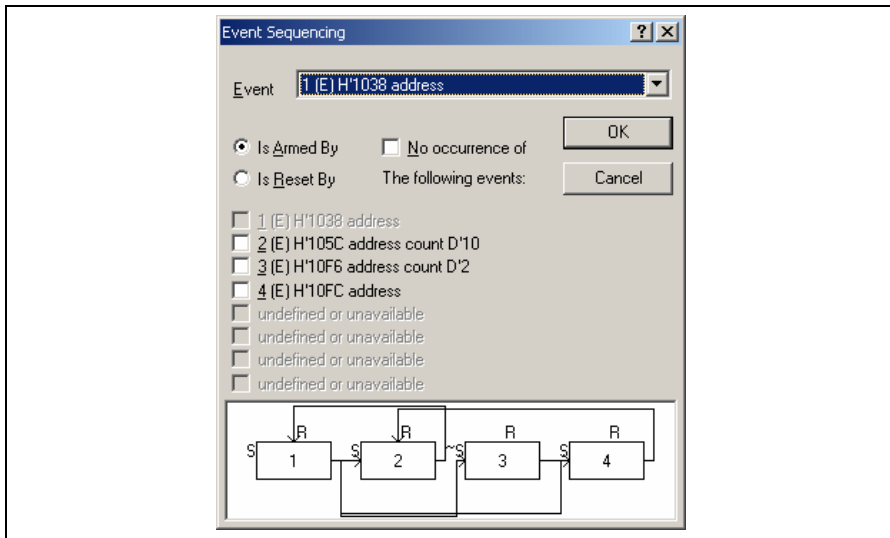

Figure 5.26 [Event Sequencing] Dialog Box

[Event]: Selects an event point to be set.

[Is Armed By]: Arms the selected event.

[Is Reset By]: Resets the selected event.

[No occurrence of]: Arms an event when the set of events being selected does not occur (only available when [Is Armed By] has been selected).

The test of conditions on event points is started with the execution of the user program. The conditions on event points have not been satisfied immediately after the execution of the user program is started.

Satisfaction of the condition on an event point allows a transition of the state to that where the condition is satisfied.

The state where the condition is satisfied is retained until the user program is stopped or the event point is reset.

When the condition on the event point is satisfied, no action will be taken even if the condition is satisfied again. If you want the action to be taken again, reset the event point so that the state transits to that where no condition is satisfied.

When the user program is stopped, the states of all the event points transit to that where no condition is satisfied.

When an event point must be in the state where its condition is satisfied or not (when [No occurrence of] is selected) as the satisfaction condition of another event point, this event point is called the arm event.

An event point can reset the tested states of conditions of other event points or itself by satisfying the condition. This event point is called a reset event.

A reset event resets event points regardless of their states where the condition is satisfied or not (e.g., resetting the pass count).

Select an event point from the [Event] combo box. To set an arm event on the selected event point, select [Is Armed By] and check the box corresponding to each event. The [No occurrence of] check box is used to set a condition that the arm event is in the state where its condition is not satisfied.

To set a reset event on the selected event point, select [Is Reset By] and check the box corresponding to each event.

At the bottom of the screen is a diagram showing the current sequencing of the events (figure 5.26). The S input sets (arms) an event and the R input resets it. The legend ~S indicates the event is set (armed) by the non-occurrence of the input events.

Figure 5.26 is an example that Ch1 is the arm event for Ch2, Ch3, and Ch4. Ch3 is the arm event for Ch4. Ch2 and Ch4 are the reset events for Ch1 and Ch2, respectively.

To satisfy the condition of the event point having an arm event, the arm event must be in the state where the condition is satisfied or not (when [No occurrence of] is selected). When multiple arm events exist on one event point, one of the arm events must be in the state where the condition is satisfied or not (when [No occurrence of] selected) to satisfy the condition of the event point.

As the condition of the arm event on one event point, either of the states where the condition is satisfied or not should be set.

To reset an event point with a reset event, the condition of the reset event must be satisfied. While the condition of the reset point is satisfied, no event point is reset even if the condition of the reset event is satisfied again.

When multiple reset events exist on one event point, the event point is reset when the condition of one of reset events is satisfied.

5.7.8 Setting Trigger Points

The trigger point is an event to output a trigger when the specified address has been accessed. Up to four trigger points can be set by using the trigger outputs (four channels) on the bus monitoring circuit of the emulator.

The settings of the trigger point are displayed and modified on the [Trigger] sheet.

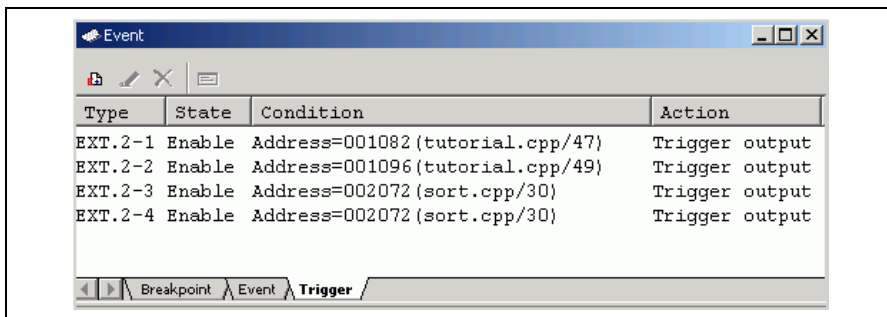

Figure 5.27 [Event] Window ([Trigger] Sheet)

Selecting [Add...] or the event point and [Edit...] from the popup menu in this window displays the [Set Address For Trigger] dialog box.

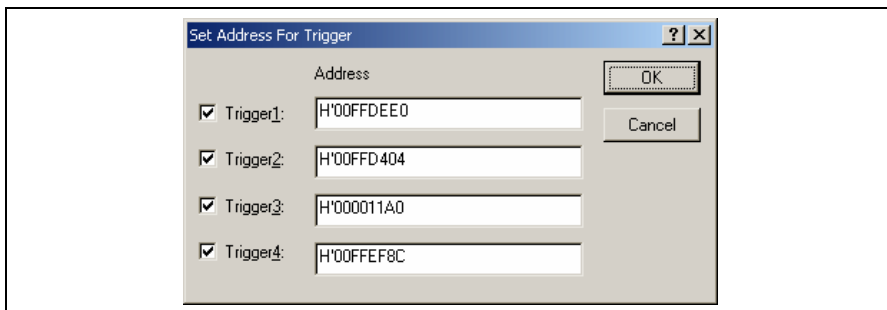

Figure 5.28 [Set Address For Trigger] Dialog Box

This dialog box allows the user to specify the address to be accessed as the trigger output condition during the user program execution. Enable or disable the trigger output point by checking the check box on the left in the screen.

- [Trigger1]: Enables the output of trigger channel 1.
- [Trigger2]: Enables the output of trigger channel 2.
- [Trigger3]: Enables the output of trigger channel 3.
- [Trigger4]: Enables the output of trigger channel 4.
- [Address]: Sets the address condition of the channel.

- Notes:
1. When the condition set for the trigger output (1 to 4) is satisfied, the high-level signal will be output from the corresponding pin (1 to 4) of the external probe 2 (EXT2) during reading or writing.
 2. Some emulators may not support the trigger point. For details, refer to section 8, Software Specifications Specific to This Product, or the online help.

5.7.9 Editing Event Points

Handlings for settings other than software breakpoints, event points, and trigger points are common. The following describes examples of such handling.

5.7.10 Modifying Event Points

Select an event point to be modified, and choose [Edit...] from the popup menu to open the dialog box that corresponds the event, which allows the user to modify the event conditions. The [Edit...] menu is only available when one event point is selected.

5.7.11 Enabling an Event Point

Select an event point and choose [Enable] from the popup menu to enable the selected event point.

5.7.12 Disabling an Event Point

Select an event point and choose [Disable] from the popup menu to disable the selected event point. When an event point is disabled, the event point will remain in the list, but an event will not occur when the specified conditions have been satisfied.

5.7.13 Deleting an Event Point

Select an event point and choose [Delete] from the popup menu to remove the selected event point. To retain the event point but not have it cause an event when its conditions are met, use the [Disable] option (see section 5.7.12, Disabling an Event Point).

Note: No trigger point can be deleted. Use the [Disable] option to clear the settings.

5.7.14 Deleting All Event Points

Choose [Delete All] from the popup menu to remove all event points.

Note: No trigger point can be deleted. If [Delete All] is selected, the settings of all channels become disabled.

5.7.15 Viewing the Source Line for an Event Point

Select an event point and choose [Go to Source] from the popup menu to open the [Editor] or [Disassembly] window at address of event point. The [Go to Source] menu is only available when one event point that has the corresponding source file is selected.

5.8 Viewing the Trace Information

The emulator acquires the results of each instruction execution into the trace buffer as trace information and displays it in the [Trace] window. The conditions for the trace information acquisition can be specified in the [Trace Acquisition] dialog box.

Since trace information in bus-cycles is acquired by the hardware circuit and stored in the trace buffer, the realtime operation is retained. The [Trace] window displays the content of the trace buffer, which records up to 32,768 bus cycles from the last program run and is always updated.

5.8.1 Opening the [Trace] Window

To open the [Trace] window, choose [View -> Code -> Trace] or click the [Trace] toolbar button ().

5.8.2 Acquiring Trace Information

When the emulator does not set the acquisition condition of the trace information, all bus cycles are acquired by default without any condition (free trace mode).

In the free trace mode, trace acquisition is started with the execution of the user program and stopped by halting the user program. The acquired trace information is displayed in the [Trace] window.

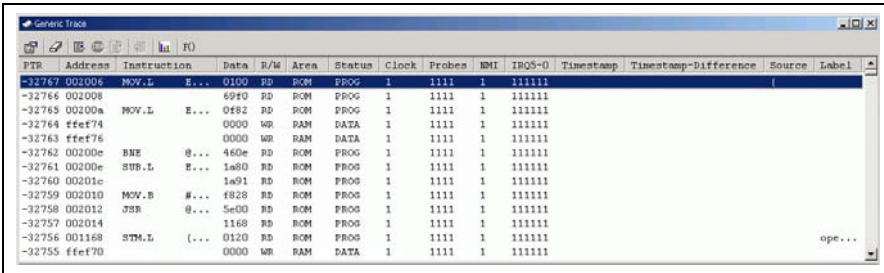

PTR	Address	Instruction	Data	R/W	Area	Status	Clock	Proben	NMT	IRQ5-0	Timestamp	Timestamp-Difference	Source	Label
-32767	002006	MOV.L	E...	0100	RD	ROM	PROG	1	1111	1	111111			
-32766	002009			69F0	RD	ROM	PROG	1	1111	1	111111			
-32765	00200a	MOV.L	E...	0482	RD	ROM	PROG	1	1111	1	111111			
-32764	ffeef74			0000	WR	RAM	DATA	1	1111	1	111111			
-32763	ffeef76			0000	WR	RAM	DATA	1	1111	1	111111			
-32762	00200e	BNE	@...	460e	RD	ROM	PROG	1	1111	1	111111			
-32761	00200e	SUB.L	E...	1a80	RD	ROM	PROG	1	1111	1	111111			
-32760	002010			1a91	RD	ROM	PROG	1	1111	1	111111			
-32759	002010	MOV.B	#...	1828	RD	ROM	PROG	1	1111	1	111111			
-32758	002012	JBR	@...	5e00	RD	ROM	PROG	1	1111	1	111111			
-32757	002014			1160	RD	ROM	PROG	1	1111	1	111111			
-32756	001168	STM.L	[...]	0120	RD	ROM	PROG	1	1111	1	111111			ope...
-32755	ffeef70			0000	WR	RAM	DATA	1	1111	1	111111			

Figure 5.29 [Trace] Window

This window displays the following trace information items:

[PTR]: Cycle number in the trace buffer. When the most recent record is record 0, earlier record numbers go backwards (-1, -2, ...). If a delay count has been set, the cycle number where the trace stop condition has been satisfied is record 0. For the cycle (during delay) executed until the trace has stopped, earlier record numbers go forward (+1, +2, ...) the most recent record.

[Address]: Address (6-digit hexadecimal)

[Instruction]: Disassembled code of the executed instruction

[Data]: Data bus value, displayed as 2-digit or 4-digit hexadecimal

[R/W]: Whether access was read (RD) or write (WR)

[Area]: Memory area being accessed; ROM, RAM, 8- or 16-bit I/O, 8- or 16-bit EXT (external), or DTC RAM (not available when a time stamp is acquired)

[Status]:	Bus status during this cycle; DTC operation, PROG (prefetch), Data (CPU data access cycle), Refresh (refresh cycle), or DMAC (DMAC cycle) (not available when a time stamp is acquired)
[Clock]:	Number of clock cycles in bus cycle as 1 to 8. To indicate more clock cycles, "OVR" is displayed (not available when a time stamp is acquired).
[Probes]:	A 4-bit binary number showing the four probe pins in the order of Probe 4, Probe 3, Probe 2, and Probe 1 from the left (not available when a time stamp is acquired).
[NMI]:	Status of the NMI input (not available when a time stamp is acquired)
[IRQ7-0]:	Status of eight IRQ inputs (not available when a time stamp is acquired)
[Timestamp]:	Time stamp of the record. Time stamps start from zero each time the user program is executed. The timer resolution depends on the time stamp clock rate selected in the trace acquisition (only available when a time stamp is acquired).
[Source]:	Source program
[Label]:	Label information that corresponds to the address (if defined)
[Timestamp-Difference]:	Displays the difference from the timestamp value shown on the previous line (only available when a time stamp is acquired).
Note:	Items other than [PTR], [Address], [Instruction], [Data], [R/W], [Area], [Status], [Probes], [Timestamp], [Source], [Label], and [Timestamp-Difference] vary according to the emulator in use. For details, refer to section 8, Software Specifications Specific to This Product, or the online help.

It is possible to hide any column not necessary in the [Trace] window. Selecting a column you want to hide from the popup menu displayed by clicking the right-hand mouse button on the header column hides that column. To display the hidden column, select the column from the said popup menu again.

5.8.3 Specifying Trace Acquisition Conditions

The capacity of the trace buffer is limited. When the buffer becomes full, the oldest trace information is overwritten. Setting the trace acquisition condition allows acquisition of useful trace information and effective use of the trace buffer. The condition is enabled by the event point to control starting, stopping, and ending the trace acquisition. For event points, refer to section 5.7, Using the Event Points.

The trace acquisition condition is set in the [Trace Acquisition] dialog box that is displayed by selecting [Acquisition...] from the popup menu.

The [Trace Acquisition] dialog box has the following pages:

Table 5.4 [Trace Acquisition] Dialog Box Pages

Page	Item
[General]	Sets trace acquisition conditions.
[Stop]	Sets trace stop conditions (without a delay).
[Delayed Stop]	Sets trace stop conditions (with a delay).
[1] to [4]	Sets the range trace (only available when the free trace mode is disabled).

(1) [General] page

Sets trace acquisition conditions.

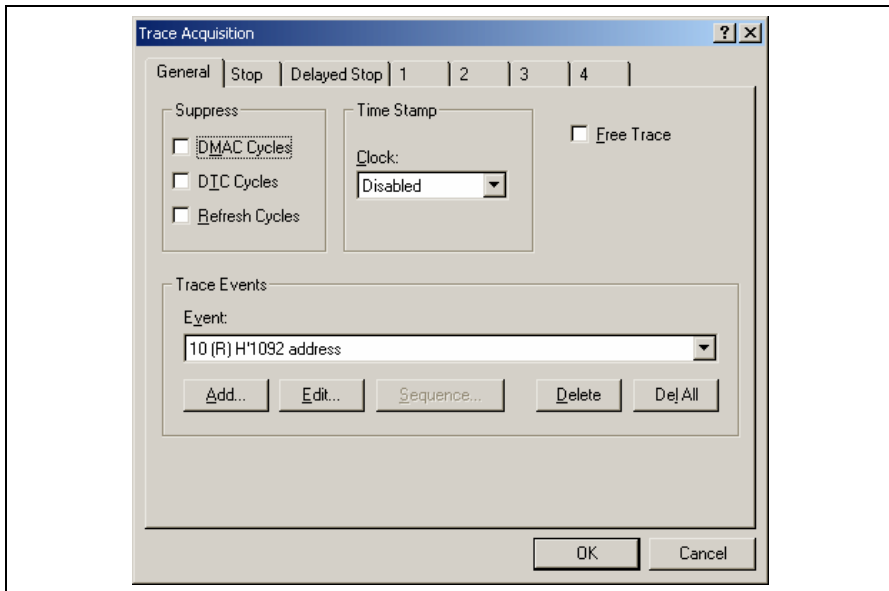

Figure 5.30 [Trace Acquisition] Dialog Box ([General] Page)

- [Suppress]: Acquires no trace information of the specified types of bus cycle.
- [Time Stamp]: Sets a condition for time stamping.
- [Clock]: Select either from Disabled, 125 ns, 250 ns, 500 ns, 1 us, 2 us, 4 us, 8 us, 16 us, or 100 us as the resolution for time stamping. A time stamp has a 32-bit counter. At 125 ns the maximum time that can be measured is about 9 minutes, and at 100 μ s the maximum time is about 5 days.
When the counter overflows, its content will be cleared to continue counting. No time stamp information will be acquired when Disabled is selected.
- [Free Trace]: Checking this box enables the free trace mode.
- When the free trace mode is enabled: Starts acquiring the data immediately after program execution has been started. Only the trace halt condition is available. The range trace is unavailable and four range-trace pages (1 to 4) become disabled.
- When the free trace mode is disabled: Sets the start and halt conditions of trace acquisition.
- [Trace Events]: Sets event points to be used as trace acquisition conditions.
- [Event]: Lists the event points to be used as trace acquisition conditions.
- [Add...]: Adds a new event point.
- [Edit...]: Changes the setting for the selected event point.
- [Sequence...]: Configures an event sequence for the event point being used as a trace acquisition condition. To set up the sequence, an event must have been set.
- [Delete]: Deletes the selected event point.
- [Del All]: Deletes all event points.

- Notes:
1. The bus cycles that can be specified by the [Suppress] option vary according to the emulator in use. For details, refer to section 5.7.4, Signals to Indicate Bus States and Areas.
 2. The trace buffer is used for the time stamp information and some of the trace information. Therefore, when the time stamp is acquired, it is impossible to acquire the trace information other than PTR, Address, Instruction, Data, R/W, Source, Label, Timestamp, and Timestamp-Difference.
 3. If an event that is used for the range trace or trace stop function is deleted, that function becomes disabled.

(2) [Stop] page

Sets trace stop conditions. It is possible to set trace stop conditions with and without delay, with both allowed simultaneously.

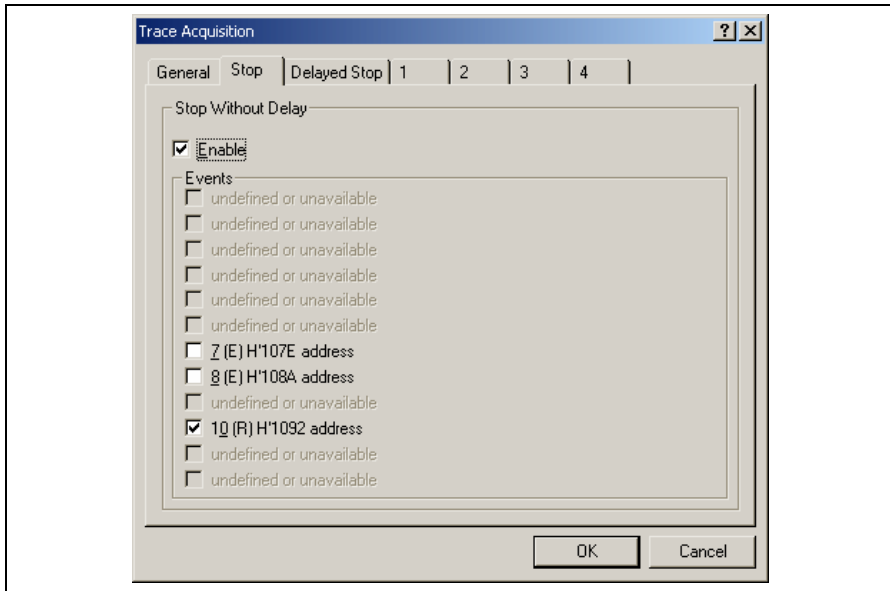

Figure 5.31 [Trace Acquisition] Dialog Box ([Stop] Page)

[Stop Without Delay]: Defines a trace stop condition.

[Enable]: Checking this box enables a trace stop.

[Events]: Lists the event points where trace acquisition conditions have been set. If the box that corresponds to an event point is checked, trace acquisition will be stopped when that event is satisfied (only available when [Enable] has been selected).

(3) [Delayed Stop] page

Sets trace stop conditions. It is possible to set trace stop conditions with and without delay, with both allowed simultaneously.

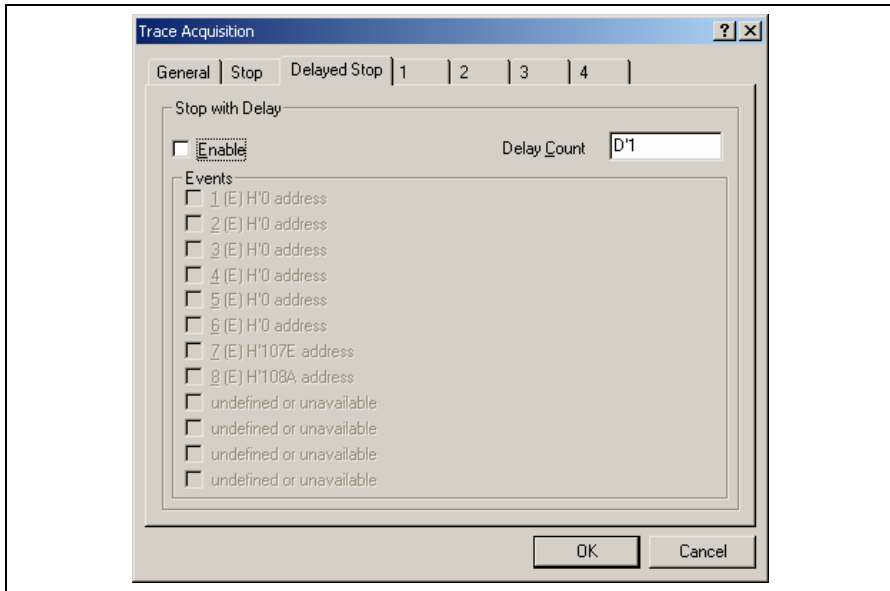

Figure 5.32 [Trace Acquisition] Dialog Box ([Delayed Stop] Page)

[Stop With Delay]: Defines a trace stop condition.

[Enable]: Checking this box enables a trace stop.

[Delay Count]: Sets the delay count (in bus cycles, range 1 to 65535). This function allows you to acquire a number of trace records after any of the specified events occur.

[Events]: Lists the event points where trace acquisition conditions have been set. If the box that corresponds to an event point is checked, trace acquisition will be stopped when that event is satisfied (only available when [Enable] has been selected).

(4) [1] to [4] pages

Sets a range trace. This is only available when the free trace mode is disabled. Select either of the following four modes: [Disabled], [Point to Point], [Range], and [Event].

- Disabled

Disables a range trace.

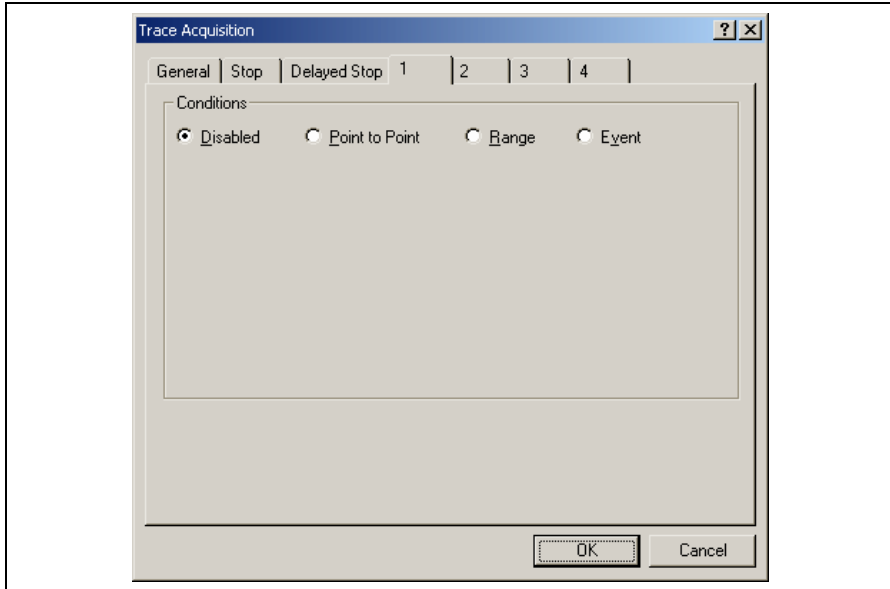

Figure 5.33 Range Trace Setting (Disabled)

- Point to Point

Acquires trace information in the specified range.

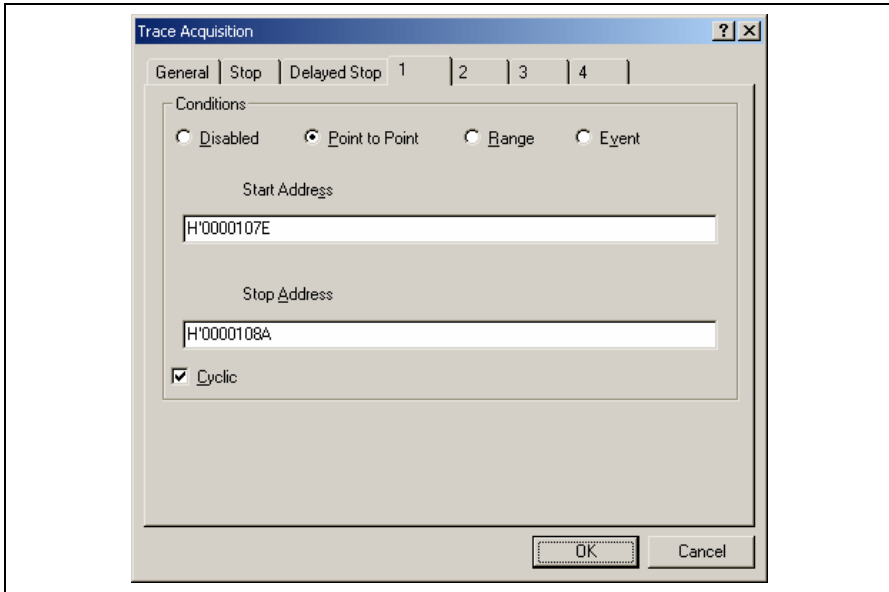

Figure 5.34 Range Trace Setting (Point to Point)

[Start Address]: Address where trace acquisition starts

[Stop Address]: Address where trace acquisition stops

[Cyclic]: When this box is checked, the event sequencing is configured so that the events reset themselves which causes tracing to be restarted when the start event occurs after the stop event.

Sets the event points that are required to start or stop trace acquisition when the start or end address is accessed, respectively.

Point to Point mode is an easy method to set up the event mode. The event to start or stop trace acquisition is an access to a single address.

Select [Cyclic] to continue acquisition of the trace information only in the specified address range.

Note: This function automatically configures a sequence of event points. Note, however, that an unexpected result may arise. In such cases, modify the setting of the sequence in the [Event Sequencing] dialog box.

- Range

Only acquires the trace information that satisfies the specified condition.

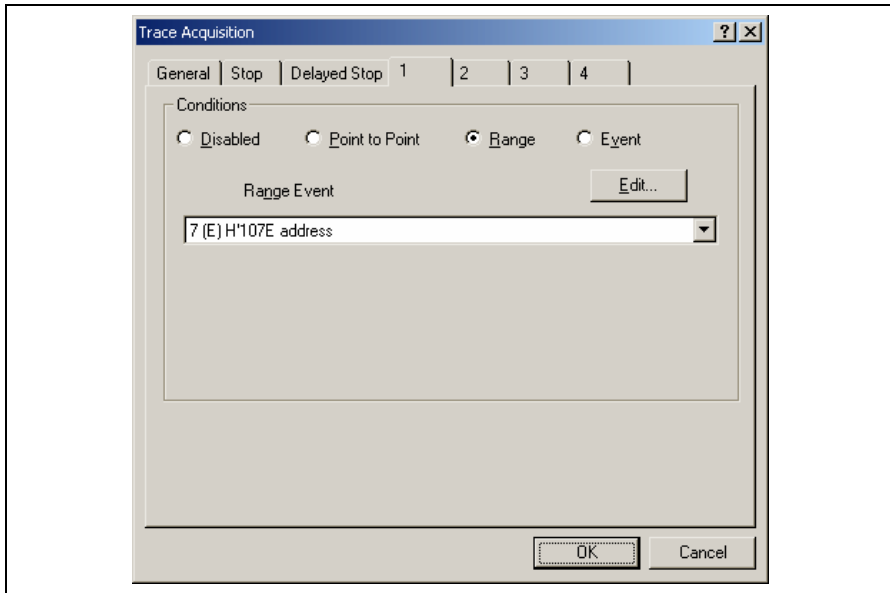

Figure 5.35 Range Trace Setting (Range)

[Range Event]: Selects an event point for which a trace acquisition condition has been set.

[Edit...]: Changes the setting for the selected event point.

Only acquires trace information from all bus cycles that matches the condition set in the selected event. This mode uses one event channel or range channel.

- Event

Acquires trace information, controlling the start and end of trace acquisition with the specified condition.

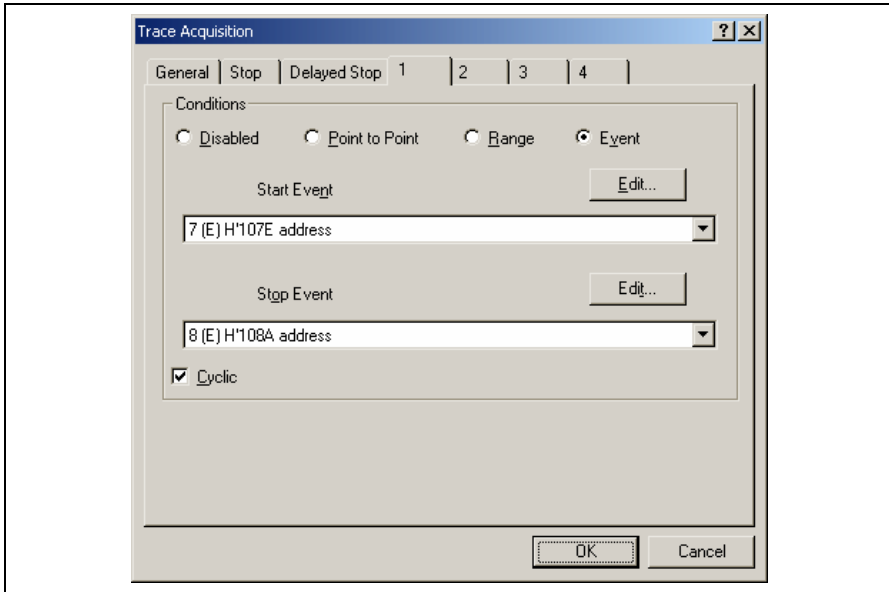

Figure 5.36 Range Trace Setting (Event)

- [Start Event]: Selects the event point for which the condition to start trace acquisition has been set.
 - [Stop Event]: Selects the event point for which the condition to stop trace acquisition has been set.
 - [Edit...]: Changes the setting for the selected event point.
 - [Cyclic]: When this box is checked, the event sequencing is configured so that the events reset themselves which causes tracing to be restarted when the start event occurs after the stop event.
- Starts and stops trace acquisition when the conditions for starting and ending are satisfied, respectively. Selecting [Cyclic] allows a continuous acquisition of trace information that can be acquired with the specified condition.

5.8.4 Searching for a Trace Record

Use the [Trace Find] dialog box to search for a trace record. To open this dialog box, choose [Find...] from the popup menu.

The [Trace Find] dialog box has the following options:

Table 5.5 [Trace Find] Dialog Box Pages

Page	Description
[General]	Sets the range for searching.
[Address]	Sets an address condition.
[Data]	Sets a data condition.
[R/W]	Selects the type of access cycles.
[Area]	Selects the area being accessed (not available when a time stamp is acquired).
[Status]	Selects the status of a bus (not available when a time stamp is acquired).
[Probes]	Selects the status of four probe signals (not available when a time stamp is acquired).
[IRQ7-0]	Selects the status of eight probe input signals (not available when a time stamp is acquired).
[Timestamp]	Specify the time stamp value for bus cycles (only available when a time stamp is acquired).

Note: Items other than [General], [Address], [Data], [R/W], [Area], [Status], [Probes], and [Timestamp] vary according to the emulator in use. For details, refer to section 8, Software Specifications Specific to This Product or the online help.

Clicking the [OK] button after setting conditions in those pages stores the settings and starts searching. Clicking the [Cancel] button closes this dialog box without setting of conditions.

When a trace record that matches the search conditions is found, the line for the trace record will be highlighted. When no matching trace record is found, a message dialog box will appear.

Only the trace information that satisfies all the conditions set in above pages will be searched.

If a find operation is successful, selecting [Find Next] from the popup menu will move to the next found item.

(1) [General] page

Set the range for searching.

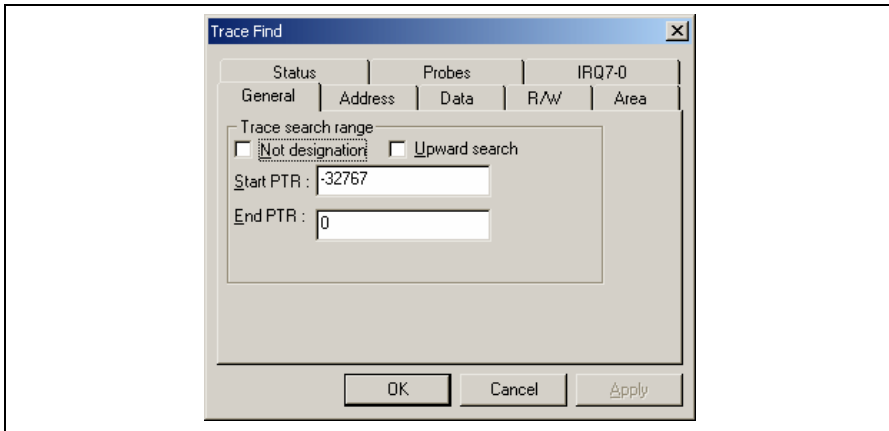

Figure 5.37 [Trace Find] Dialog Box ([General] Page)

[Trace search range]: Sets the range for searching.

[Not designation]: Searches for information that does not match the conditions set in other pages when this box is checked.

[Upward search]: Searches upwards when this box is checked.

[Start PTR]: Enters a PTR value to start a search.

[End PTR]: Enters a PTR value to end a search.

Note: Along with setting the range for searching, PTR values to start and end searching can be set in the [Start PTR] and [End PTR] options, respectively.

(2) [Address] page

Set an address condition.

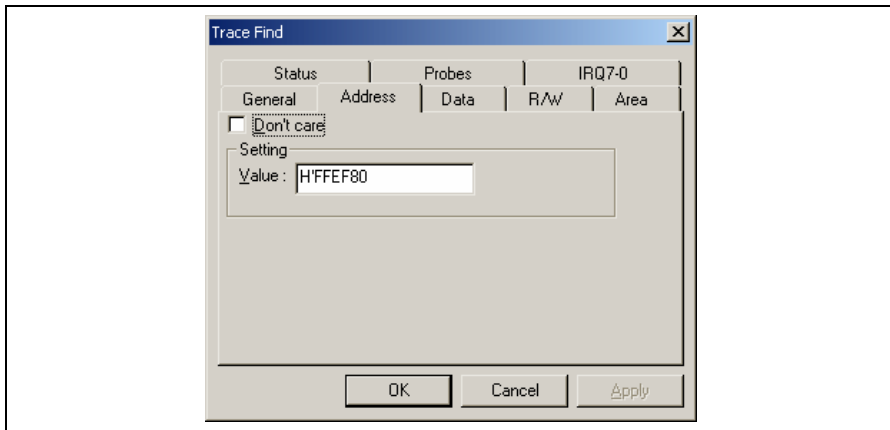

Figure 5.38 [Trace Find] Dialog Box ([Address] Page)

[Don't care]: Detects no address when this box is checked.

[Setting]: Detects the specified address.

[Value]: Enter the address value (not available when [Don't care] has been checked).

(3) [Data] page
Set a data condition.

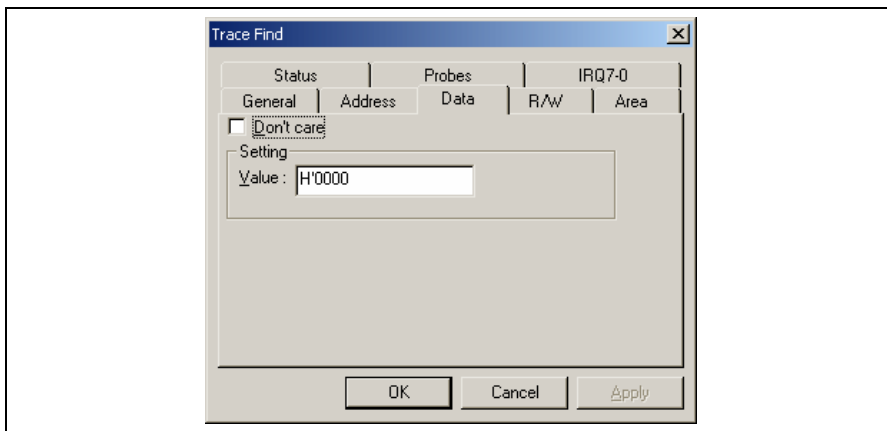

Figure 5.39 [Trace Find] Dialog Box ([Data] Page)

[Don't care]: Detects no data when this box is checked.

[Setting]: Detects the specified data.

[Value]: Enter the data value (not available when [Don't care] has been checked).

(4) [R/W] page

Select the type of access cycles.

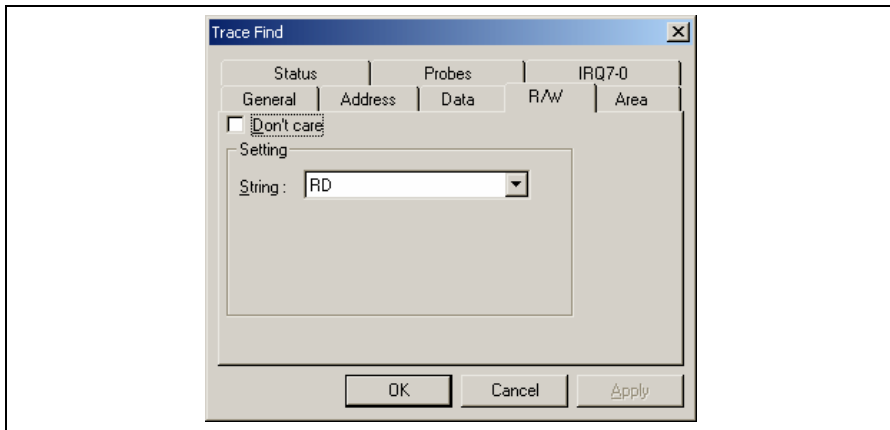

Figure 5.40 [Trace Find] Dialog Box ([R/W] Page)

[Don't care]: Detects no read/write condition when this box is checked.

[Setting]: Detects the specified read/write condition.

[String]: Select a read/write condition (not available when [Don't care] has been checked).

RD: Read cycle

WR: Write cycle

(5) [Area] page

Select the area being accessed. The selection is not available when a time stamp is acquired.

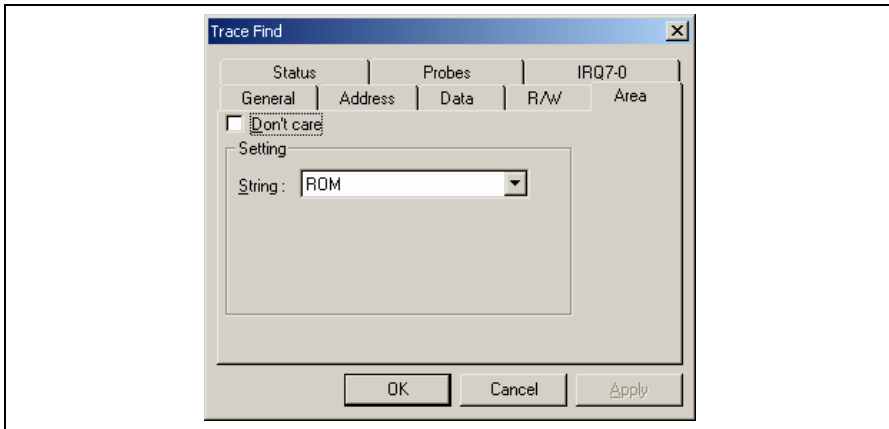

Figure 5.41 [Trace Find] Dialog Box ([Area] Page)

[Don't care]: Detects no area condition when this box is checked.

[Setting]: Detects the specified area condition.

[String]: Select an area condition (not available when [Don't care] has been checked).

Note: Available areas vary according to the emulator in use. For details, refer to section 5.7.4, Signals to Indicate Bus States and Areas.

(6) [Status] page

Select the status of a bus. The selection is not available when a time stamp is acquired.

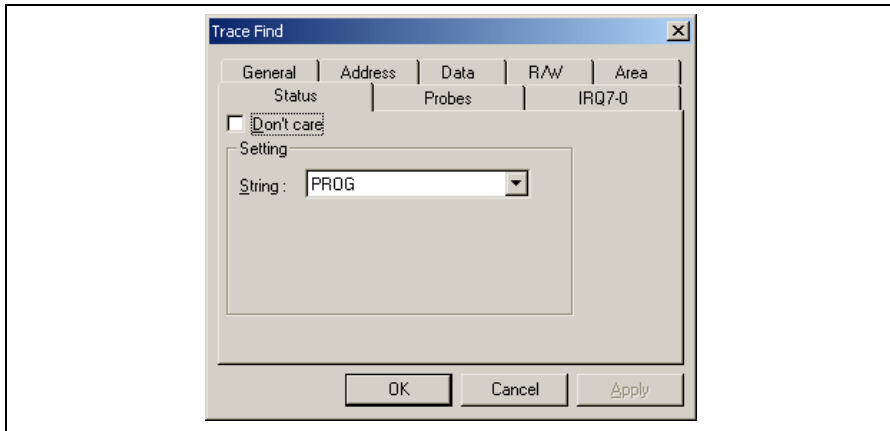

Figure 5.42 [Trace Find] Dialog Box ([Status] Page)

[Don't care]: Detects no bus condition when this box is checked.

[Setting]: Detects the specified bus condition.

[String]: Select a bus condition (not available when [Don't care] has been checked).

Note: Available bus conditions vary according to the emulator in use. For details, refer to section 5.7.4, Signals to Indicate Bus States and Areas.

(7) [Probes] page

Select the status of four probe signals. The selection is not available when a time stamp is acquired.

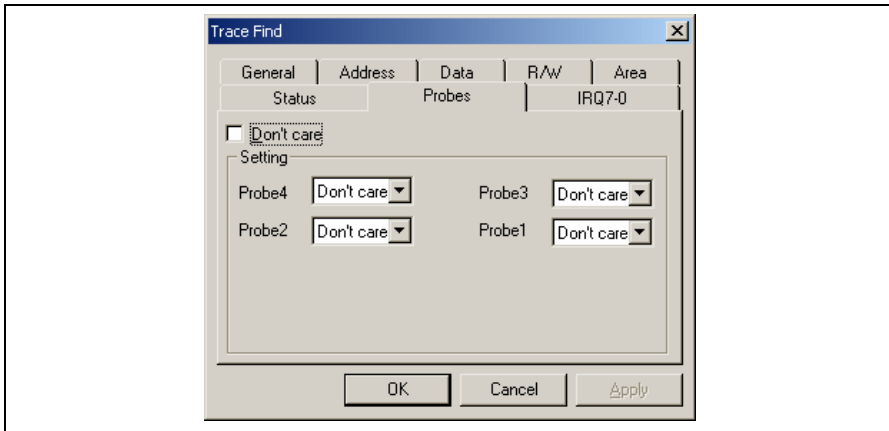

Figure 5.43 [Trace Find] Dialog Box ([Probes] Page)

[Don't care]: Detects no probe signal condition when this box is checked.

[Setting]: Detects the specified probe signal condition.

[Probe4] to [Probe1]: Select probe conditions (not available when [Don't care] has been checked).

Don't care: Detects no selected probe condition.

High: The status of the probe signal is high.

Low: The status of the probe signal is low.

(8) [IRQ7-0] page

Select the status of IRQ signals. The selection is not available when a time stamp is acquired.

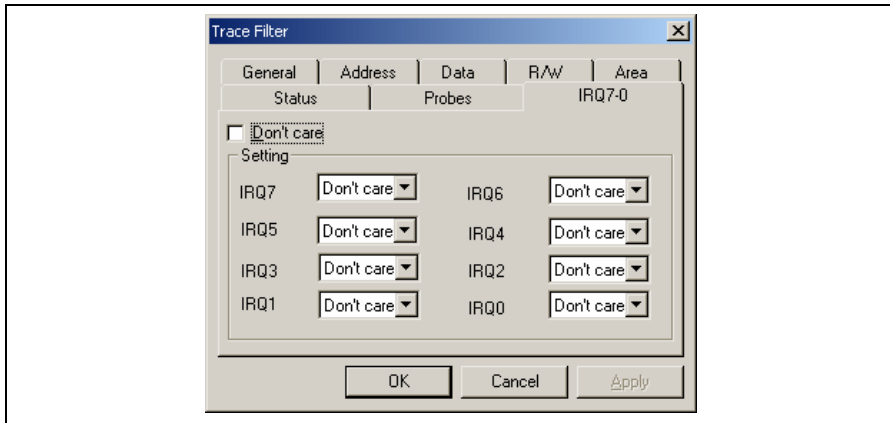

Figure 5.44 [Trace Find] Dialog Box ([IRQ7-0] Page)

[Don't care]: Detects no IRQ input condition when this box is checked.

[Setting]: Detects the specified IRQ input condition.

[IRQ7] to [IRQ0]: Select IRQ input conditions (not available when [Don't care] has been checked).

Don't care: Detects no selected IRQ input condition.

High: The status of the IRQ input is high.

Low: The status of the IRQ input is low.

(9) [Timestamp] page

Specify the time stamp value for bus cycles. The specification is not available when a time stamp is acquired.

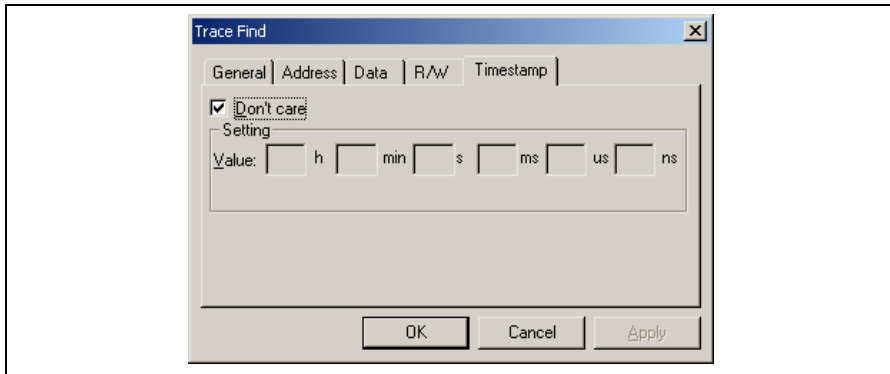

Figure 5.45 [Trace Find] Dialog Box ([Timestamp] Page)

[Don't care]: Detects no time stamp value when this box is checked.

[Setting]: Detects the specified time stamp value. (Every field must be filled in.)

[Value]: Enter the time stamp value.

The format is as follows:

hour: h, minute: min, second: s, millisecond: ms, microsecond: us, nanosecond: ns

(Not available when [Don't care] has been checked.)

5.8.5 Clearing the Trace Information

Select [Clear] from the popup menu to empty the trace buffer that stores the trace information. If several [Trace] windows are open, all [Trace] windows will be cleared as they all access the same buffer.

5.8.6 Saving the Trace Information in a File

Select [Save...] from the popup menu to open the [Save As] file dialog box, which allows the user to save the information displayed in the [Trace] window as a text file. A range can be specified based on the [PTR] number (saving the complete buffer may take several minutes). Note that this file cannot be reloaded into the [Trace] window.

Note: In filtering of trace information, the range to be saved cannot be selected. All the trace information displayed in the [Trace] window after filtering will be saved. Select a filtering range on the [General] page in the [Trace Filter] dialog box if you want to save the selected range. For details on the filtering function, refer to section 5.8.12, Extracting Records from the Acquired Information.

5.8.7 Viewing the [Editor] Window

The [Editor] window corresponding to the selected trace record can be displayed in the following two ways:

- Select a trace record and choose [View Source] from the popup menu.
- Double-click a trace record

The [Editor] or [Disassembly] window opens and the selected line is marked with a cursor.

5.8.8 Trimming the Source

Choose [Trim Source] from the popup menu to remove the white space from the left side of the source.

When the white space is removed, a check mark is shown to the left of the [Trim Source] menu. To restore the white space, choose [Trim Source] while the check mark is shown.

5.8.9 Acquiring a Snapshot of the Trace Information

A snapshot can be acquired when you need to check the trace information during execution of the user program. This is useful for checking time stamping or probe input signals. To acquire a snapshot of trace information, select [Snapshot] from the popup menu. Trace acquisition is temporarily stopped to display a record of the latest trace information, and then restarted. A snapshot of trace information is only acquired during execution of the user program.

5.8.10 Temporarily Stopping Trace Acquisition

To temporarily stop trace acquisition during execution of the user program, select [Halt] from the popup menu. This stops trace acquisition and updates the trace display. Use this method to check the trace information without stopping execution of the user program.

5.8.11 Restarting Trace Acquisition

To restart trace acquisition being stopped during execution of the user program, select [Restart] from the popup menu.

5.8.12 Extracting Records from the Acquired Information

Use the filtering function to extract the records you need from the acquired trace information. The filtering function allows the trace information acquired by hardware to be filtered by software. Unlike the settings made in the [Trace Acquisition] dialog box for acquiring trace information by conditions, changing the settings for filtering several times to filter the acquired trace information allows easy extraction of necessary information, which is useful for analysis of data. The content of the trace buffer will not be changed even when the filtering function is used. Acquiring useful information as much as possible by the [Trace Acquisition] settings improves the efficiency in analysis of data because the capacity of the trace buffer is limited.

Use the filtering function in the [Trace Filter] dialog box. To open the [Trace Filter] dialog box, select [Filter...] from the popup menu.

The [Trace Filter] dialog box has the following pages:

Table 5.6 [Trace Filter] Dialog Box Pages

Page	Description
[General]	Selects the range for filtering.
[Address]	Sets address conditions.
[Data]	Sets data conditions.
[R/W]	Selects the type of access cycles.
[Area]	Selects the area being accessed (not available when a time stamp is acquired).
[Status]	Sets the status of a bus (not available when a time stamp is acquired).
[Probes]	Selects the states of four probe signals (not available when a time stamp is acquired).
[IRQ7-0]	Selects the states of eight IRQ input signals (not available when a time stamp is acquired).
[Timestamp]	Specifies the time stamp value for bus cycles (only available when a time stamp is acquired).

Note: Items other than [General], [Address], [Data], [R/W], [Area], [Status], [Probes], and [Timestamp] vary according to the emulator in use. For details, refer to section 8, Software Specifications Specific to This Product or the online help.

Set filtering conditions and then press the [OK] button. This starts filtering according to the conditions. Clicking the [Cancel] button closes the [Trace Filter] dialog box, which holds the settings at the time when the dialog box was opened.

In filtering, only the trace information that satisfies one or more filtering conditions set in the above pages will be displayed in the [Trace] window.

Filtering conditions can be changed several times to analyze data because the content of the trace buffer is not changed by filtering.

(1) [General] page

Set the range for filtering.

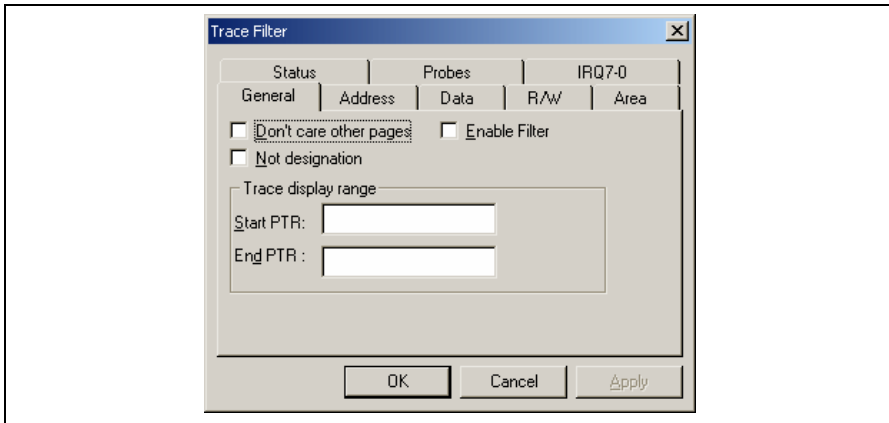

Figure 5.46 [Trace Filter] Dialog Box ([General] Page)

[Don't care other pages]: Only selects the cycle number when this box is checked. Other options become invalid.

[Enable Filter]: Enables the filter when this box is checked.

[No]: Filters information that does not match the conditions set in those pages when this box is checked.

[Trace display range]: Sets the range for filtering.

[Start PTR]: Enters a PTR value to start filtering.

[End PTR]: Enters a PTR value to end filtering.

Note: Along with setting the range for filtering, PTR values to start and end filtering can be set in the [Start PTR] and [End PTR] options, respectively.

(2) [Address] page
Set address conditions.

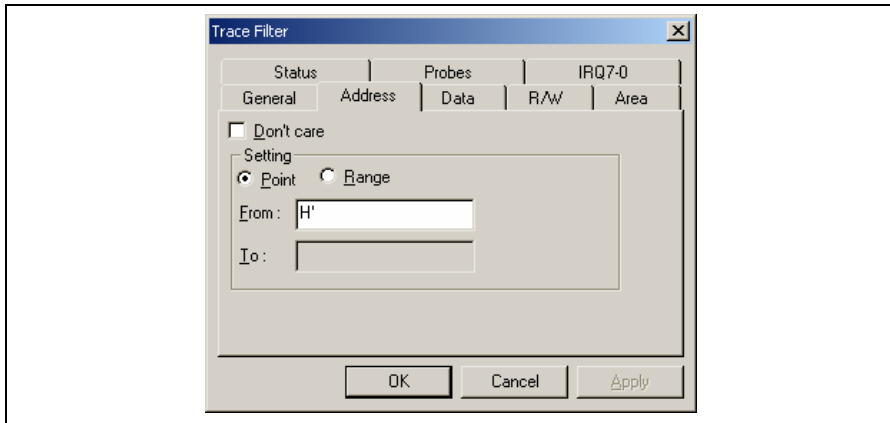

Figure 5.47 [Trace Filter] Dialog Box ([Address] Page)

[Don't care]: Detects no address when this box is checked.

[Setting]: Detects the specified address.

[Point]: Specifies a single address (not available when [Don't care] has been checked).

[Range]: Specifies an address range (not available when [Don't care] has been checked).

[From]: Enter a single address or the start of the address range (not available when [Don't care] has been checked).

[To]: Enter a single address or the end of the address range (only available when [Range] has been selected).

Note: Along with setting the address range, the start and end of the address range can be set in the [From] and [To] options, respectively.

(3) [Data] page
Set a data condition.

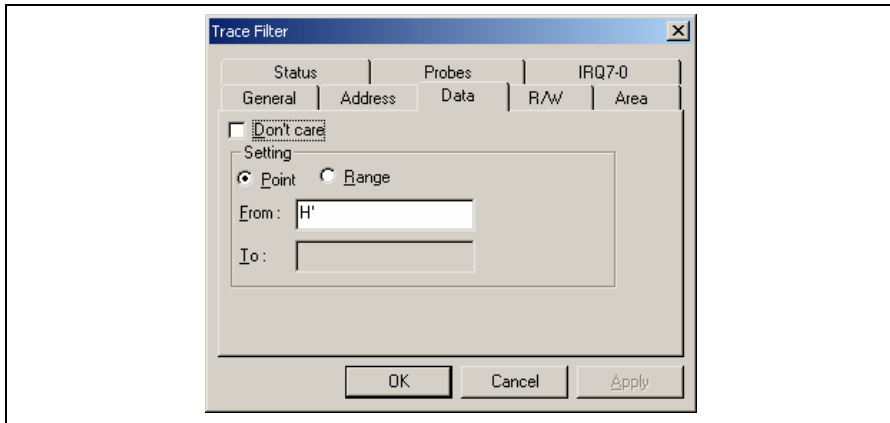

Figure 5.48 [Trace Filter] Dialog Box ([Data] Page)

[Don't care]: Detects no data when this box is checked.

[Setting]: Detects the specified data.

[Point]: Specifies single data (not available when [Don't care] has been checked).

[Range]: Specifies a data range (not available when [Don't care] has been checked).

[From]: Enter single data or the minimum value of the data range (not available when [Don't care] has been checked).

[To]: Enter the maximum value of the data range (only available when [Range] has been selected).

Note: Along with setting the data range, the minimum and maximum values can be set in the [From] and [To] options, respectively.

(4) [R/W] page

Select the type of access cycles.

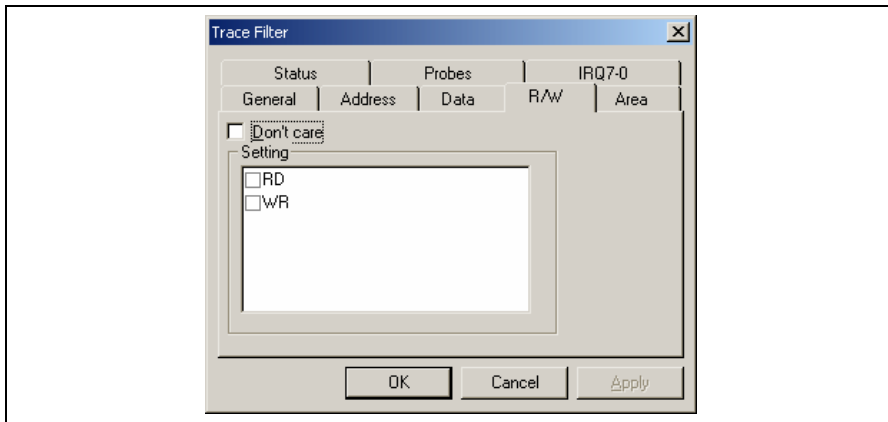

Figure 5.49 [Trace Filter] Dialog Box ([R/W] Page)

[Don't care]: Detects no read/write condition when this box is checked.

[Setting]: Detects the specified read/write condition.

RD: Detects read cycles when this box is checked (not available when [Don't care] has been checked).

WR: Detects write cycles when this box is checked (not available when [Don't care] has been checked).

(5) [Area] page

Select the area being accessed. The selection is not available when a time stamp is acquired.

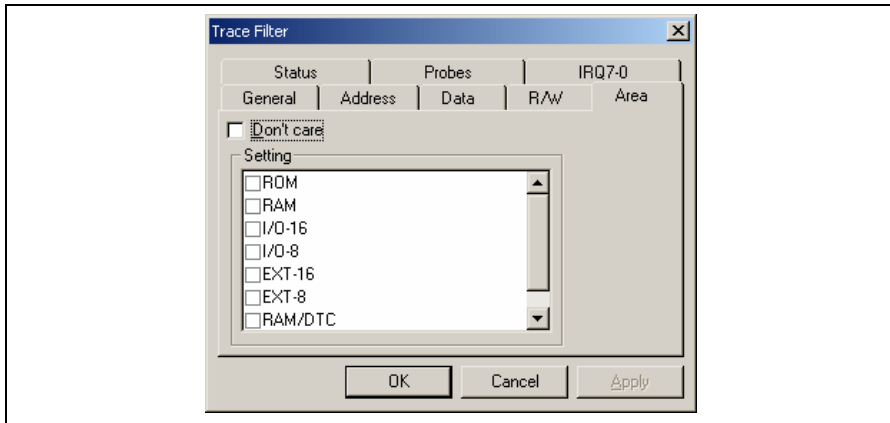

Figure 5.50 [Trace Filter] Dialog Box ([Area] Page)

[Don't care]: Detects no area condition when this box is checked.

[Setting]: Detects the specified area condition (not available when [Don't care] has been checked).

Note: Available area conditions vary according to the emulator in use. For details, refer to section 5.7.4, Signals to Indicate Bus States and Areas.

(6) [Status] page

Select the status of a bus. The selection is not available when a time stamp is acquired.

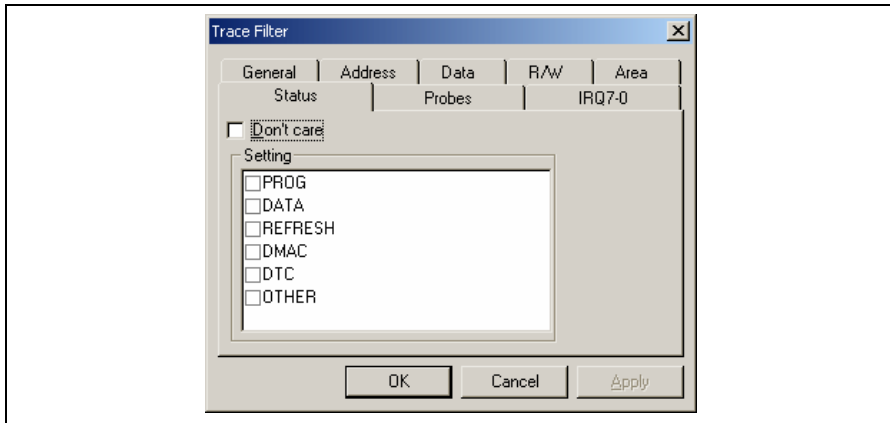

Figure 5.51 [Trace Filter] Dialog Box ([Status] Page)

[Don't care]: Detects no bus condition when this box is checked.

[Setting]: Detects the specified bus condition (not available when [Don't care] has been checked).

Note: Available bus conditions vary according to the emulator in use. For details, refer to section 5.7.4, Signals to Indicate Bus States and Areas.

(7) [Probes] page

Select the status of four probe signals. The selection is not available when a time stamp is acquired.

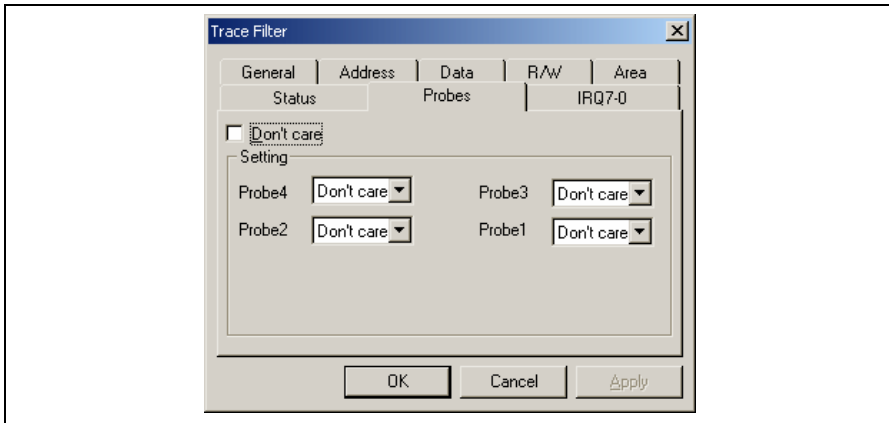

Figure 5.52 [Trace Filter] Dialog Box ([Probes] Page)

[Don't care]: Detects no probe signal condition when this box is checked.

[Setting]: Detects the specified probe signal condition.

[Probe4] to [Probe1]: Select probe conditions (not available when [Don't care] has been checked).

Don't care: Detects no selected probe condition.

High: The status of the probe signal is high.

Low: The status of the probe signal is low.

(8) [IRQ7-0] page

Select the status of IRQ signals. The selection is not available when a time stamp is acquired.

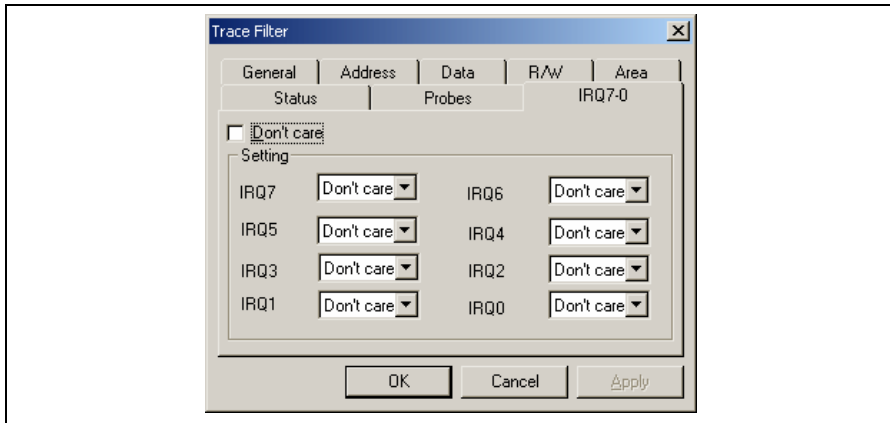

Figure 5.53 [Trace Filter] Dialog Box ([IRQ7-0] Page)

[Don't care]: Detects no IRQ input condition when this box is checked.

[Setting]: Detects the specified IRQ input condition.

[IRQ7] to [IRQ0]: Select IRQ input conditions (not available when [Don't care] has been checked).

Don't care: Detects no selected IRQ input condition.

High: The status of the IRQ input is high.

Low: The status of the IRQ input is low.

(9) [Timestamp] page

Specify the time stamp value for bus cycles. The specification is not available when a time stamp is acquired.

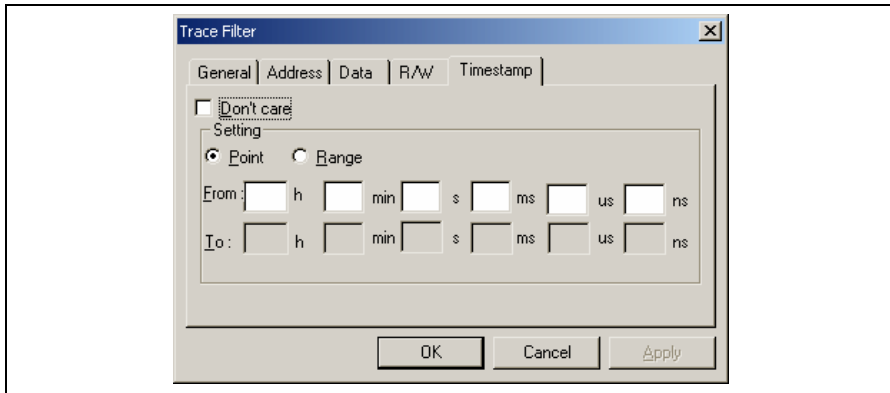

Figure 5.54 [Trace Filter] Dialog Box ([Timestamp] Page)

[Don't care]: Detects no time stamp value when this box is checked.

[Setting]: Detects the specified time stamp value.

[Point]: Specifies a single time stamp (not available when [Don't care] has been checked).

[Range]: Specifies a time stamp range (not available when [Don't care] has been checked).

[From]: Enter a single time stamp value or the minimum value of the time stamp range.
The format is as follows:
hour: h, minute: min, second: s, millisecond: ms, microsecond: us, nanosecond: ns
(Not available when [Don't care] has been checked.)

[To]: Enter the maximum value of the time stamp range.
The format is as follows:
hour: h, minute: min, second: s, millisecond: ms, microsecond: us, nanosecond: ns
(Only available when [Range] has been selected.)

Note: Along with setting the time stamp range, the minimum and maximum time stamp values can be set in the [From] and [To] options, respectively.

5.8.13 Calculating the Difference in Time Stamping

Select [Timestamp Difference...] from the popup menu to calculate the time difference between the two points selected by the result of tracing in acquisition of time stamp information.

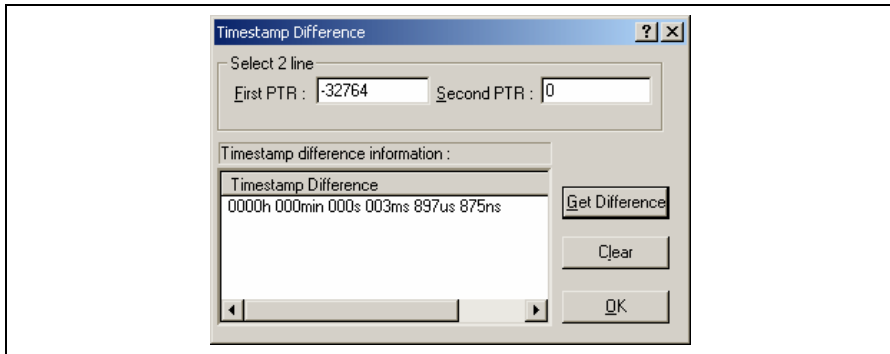

Figure 5.55 [Timestamp Difference] Dialog Box

- [Select 2 line]: Select trace records to calculate the time stamp difference.
- [First PTR]: Specifies the first pointer to measure the difference. The pointer of the line selected on the Trace window is displayed by default.
- [Second PTR]: Specifies the second pointer to measure the difference.
- [Timestamp Difference]: Displays the results of calculation.
- [Get Difference]: Calculates the difference between the specified two points and display its result in the [Timestamp Difference] list.
- [Clear]: Clears all the results in the [Timestamp Difference] list.
- [OK]: Closes the dialog box. All the results in the [Timestamp Difference] list are cleared.

5.8.14 Analyzing Statistical Information

Choose [Statistic] from the popup menu to open the [Statistic] dialog box and analyze statistical information under the specified conditions.

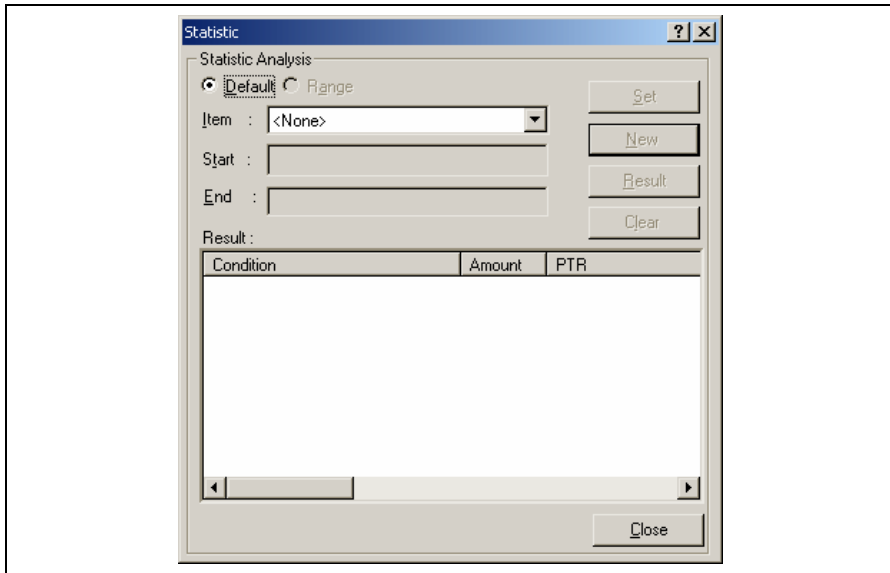

Figure 5.56 [Statistic] Dialog Box

- [Statistic Analysis]: Setting required for analysis of statistical information.
- [Default]: Sets a single input value or character string.
- [Range]: Sets the input value or character string as a range.
- [Item]: Sets the item for analysis.
- [Start]: Sets the input value or character string. To set a range, the start value must be specified here.
- [End]: Specify the end value if a range has been set (only available when [Range] has been selected).
- [Set]: Adds a new condition to the current one.
- [New]: Creates a new condition.
- [Result]: Obtains the result of statistical information analysis.
- [Clear]: Clears all conditions and results of statistical information analysis.
- [Close]: Closes this dialog box. All the results displayed in the [Result] list will be cleared.

This dialog box allows the user to analyze statistical information concerning the trace information. Set the target of analysis in [Item] and the input value or character string by [Start] and [End]. Click the [Result] button after setting a condition by pressing the [New] or [Add] button to analyze the statistical information and display its result in the [Result] list.

Note: In this emulator, only [PTR] can be set as a range. Each of other items must be specified as a character string. In analysis of statistical information, character strings are compared with those displayed in the [Trace] window. Only those that completely match are counted. Note, however, that this test is not case sensitive. The number of blanks will not be cared either.

5.8.15 Extracting Function Calls from the Acquired Trace Information

To extract function calls from the acquired trace information, select [Function Call...] from the popup menu. The [Function Call Display] dialog box will be displayed.

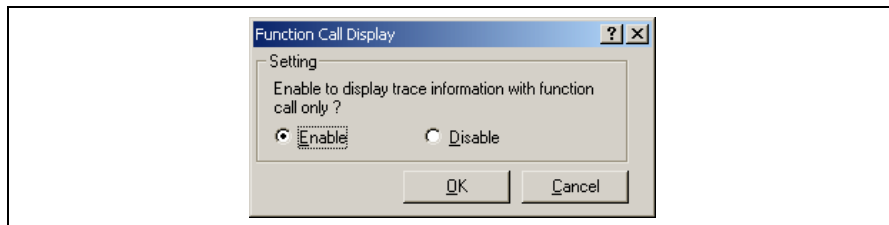

Figure 5.57 [Function Call Display] Dialog Box

[Setting]: Selects whether or not to extract function calls.

[Enable]: Extracts function calls.

[Disable]: Does not extract function calls.

When [Enable] is selected, only the cycles that include function calls are extracted for display from the acquired trace information. The content of the trace buffer is not changed by extraction of function calls. Using this function for the result of the free trace or the trace information that includes function calls allows the user to know the order of function calls.

5.9 Analyzing Performance

Use the performance analysis function to measure the rate of execution time. The performance analysis function does not affect the realtime operation because it measures the rate of execution time in the specified range by using the circuit for measurement of hardware performance included in the emulator.

Select either of the following five modes according to the purpose of measurement.

Table 5.7 Available Measurement Modes

Mode	Description	Purpose
Time Of Specified Range Measurement	Measures the execution time and execution count in the specified range.	Measurement of time taken for processing of functions except for that required for child functions called from the functions.
Start Point To End Point Measurement	Measures the execution time and execution count between the specified addresses.	Measurement of time taken for processing of functions.
Start Range To End Range Measurement	Measures the execution time from a specified range to another specified range.	Measurement of execution time spent from calling of any of sequential subroutines to calling of any of another sequential subroutines in a program that includes subroutines in sequence, such as an assembly program.
Access Count Of Specified Range Measurement	Measures the number of times a specified range is accessed from another specified range.	Measurement of the number of times a global variable is accessed from a specific function.
Called Count Of Specified Range Measurement	Measures the number of times a specified range has called another specified range.	Measurement of the number of times a function is called from a specific function.

Use eight performance channels installed on the circuit for measurement of hardware performance in the emulator for setting of conditions for measurement. Up to eight points can be set.

Note, however, that up to four points can be set in Start Range To End Range Measurement, Access Count Of Specified Range Measurement, or Called Count Of Specified Range Measurement because two sequential points are used for setting a condition in these modes.

Table 5.8 Mode Settings for Measurement

Page	Point							
	1	2	3	4	5	6	7	8
Time Of Specified Range Measurement	0	0	0	0	0	0	0	0
Start Point To End Point Measurement	0	0	0	0	0	0	0	0
Start Range To End Range Measurement	0	—	0	—	0	—	0	—
Access Count Of Specified Range Measurement	0	—	0	—	0	—	0	—
Called Count Of Specified Range Measurement	0	—	0	—	0	—	0	—

Note: 0: Available
 —: Not available

Note: Only one point is used in Time Of Specified Range Measurement and Start Point To End Point Measurement, while two sequential points are used in Start Range To End Range Measurement, Access Count Of Specified Range Measurement, and Called Count Of Specified Range Measurement. The conditions that have been set will be canceled when switching these modes of different types.

5.9.1 Opening the [Performance Analysis] Window

Choose [View -> Performance -> Performance Analysis] or click the [PA] toolbar button  to open the [Select Performance Analysis Type] dialog box.

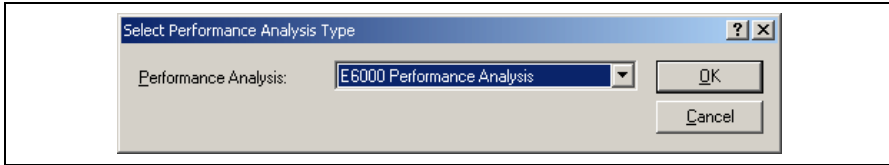

Figure 5.58 [Select Performance Analysis Type] Window

Select [E6000 Performance Analysis] and then click the [OK] button to open the [Performance Analysis] window.

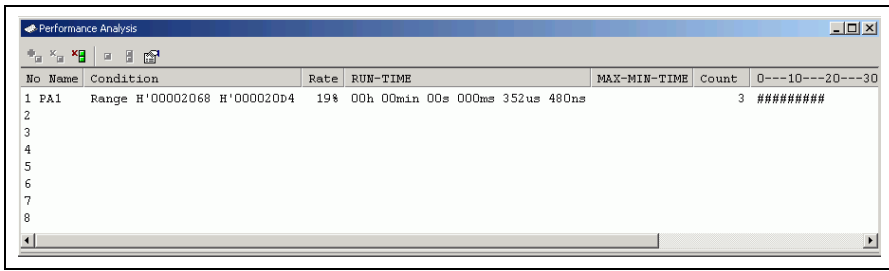

Figure 5.59 [Performance Analysis] Window

This window displays the rate of execution time in the area selected by the user during the last program run in percentages, histogram, or numerical values.

It is possible to hide any column not necessary in the [Performance Analysis] window. Selecting a column you want to hide from the popup menu displayed by clicking the right-hand mouse button on the header column hides that column. To display the hidden column, select the column from the said popup menu again.

5.9.2 Setting Conditions for Measurement

Conditions for measurement can be displayed and changed in the [Performance Analysis] window. Select a point where a condition is to be set, and then select [Set...] from the popup menu to display the [Performance Analysis Properties] dialog box.

Select either from the following five modes as the condition by the [Measurement Method] option:

Table 5.9 Conditions for Measurement (Measurement Method)

[Measurement Method] Option
Time Of Specified Range Measurement
Start Point To End Point Measurement
Start Range To End Range Measurement
Access Count Of Specified Range Measurement
Called Count Of Specified Range Measurement

Set a condition for measurement according to the mode being selected. The parameters to be set depend on the modes.

The [Performance Analysis] window has a support function to enter the address range of a function automatically if the name of the function is entered to set an address range. Entering a function name in the [Input Function Range] dialog box displayed by clicking the [...] button on the [Performance Analysis Properties] dialog box automatically enters the address range of the function.

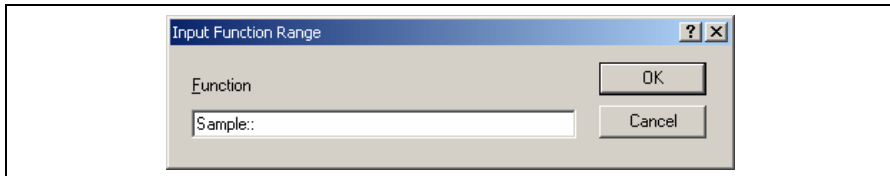

Figure 5.60 [Input Function Range] Window

- Notes:
1. Entering the name of an overload function or a class opens the [Select Function] dialog box. Select a function in this dialog box.
 2. The addresses figured out are just for reference. In some cases, the end address of a function may be different. Check the last instruction of the function in the [Disassembly] window to correct the value set in [End Address] so that it will be the address of the last instruction (in general, the last instruction of a function is a RTS instruction). A label name or an expression can be entered instead of an address value in boxes where an address should be entered.

(1) Time Of Specified Range Measurement

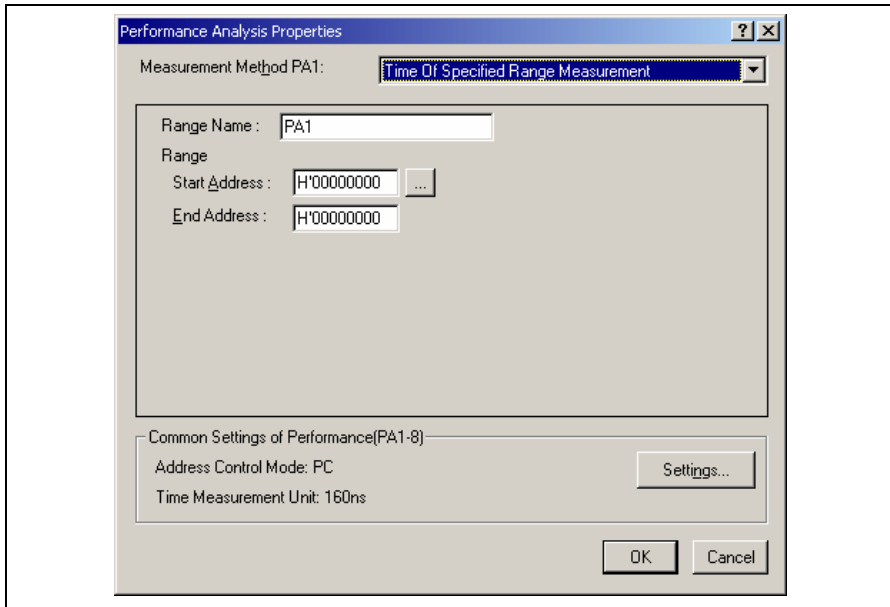

Figure 5.61 Time Of Specified Range Settings

- [Range Name]: The name of the range to be measured
- [Range]: The range for the Time Of Specified Range Measurement
- [Start Address]: Address to start measurement
- [End Address]: Address to end measurement

Measures the execution time and the execution count in the range between the start address and end address. Starts measurement with a detected program prefetch in the range specified between the start and end addresses, and then stops with a detected program prefetch out of the specified range. Measurement can be restarted with a detected program prefetch in the specified range. The execution count is incremented every time the program is prefetched at the end address of the specified range. The execution time measured does not include the time spent while being called from the specified range.

(2) Start Point To End Point Measurement

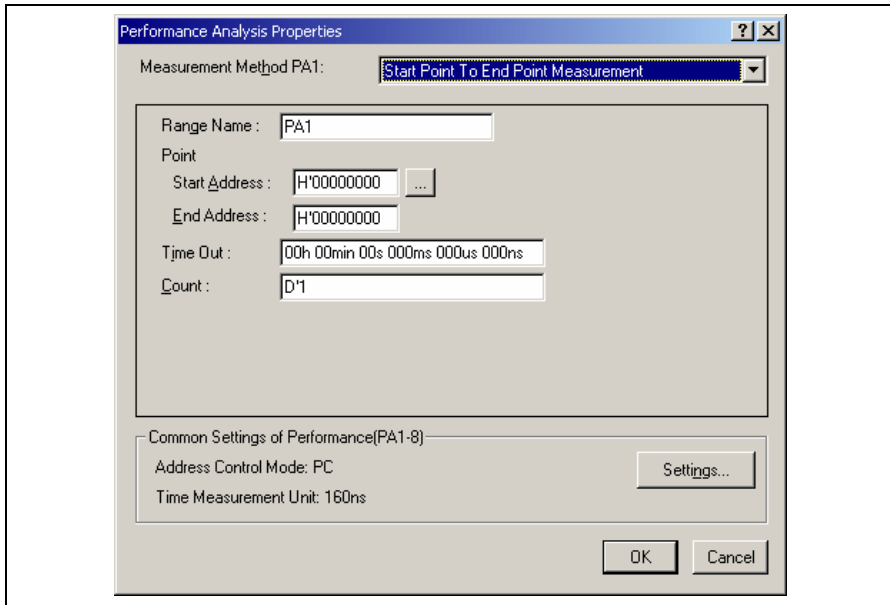

Figure 5.62 Start Point To End Point Measurement Settings

[Range Name]: The name of the range to be measured

[Point]: The range for the Start Point To End Point Measurement

[Start Address]: Address to start measurement

[End Address]: Address to end measurement

[Time Out]: The timeout value to finish measurement. When the minimum time for measurement is 160 ns, 40 ns, or 20 ns, enter the value as follows.
Example: 1h 2min 3s 123ms 456us 789ns

If the CPU operating mode is target, enter a hexadecimal number in 10 digits.
Example: 123456789A

A break occurs every time a value measured in the specified range exceeds the timeout value (not the total time). This is only available for channel 1.

[Count]: The count-up value used in measurement of the execution count. A break occurs every time the execution count exceeds the count-up value. This is only available for channel 1.

Measures the execution time and the execution count in the range between start address and end address. Starts measurement with a detected program prefetch at the start address, and then stops with a detected program prefetch at the end address. The execution count is incremented every time the program is prefetched at the end address of the specified range. The execution time measured includes the time spent while being called from the specified range. When either from one to four points is selected, the maximum and minimum time in the specified range can be measured.

- Notes:
1. When [Time Out] is selected in the Start Point To End Point Measurement mode, the execution time will not be measured correctly.
 2. When [Time Out] and [Count] are selected, satisfaction of either of these options stops execution of the user program (performance break).
 3. Only channel 1 can be used for [Time Out] and [Count]. Use other channels if you do not want to select [Time Out] or [Count] in the Start Point To End Point Measurement mode.

(3) Start Range To End Range Measurement

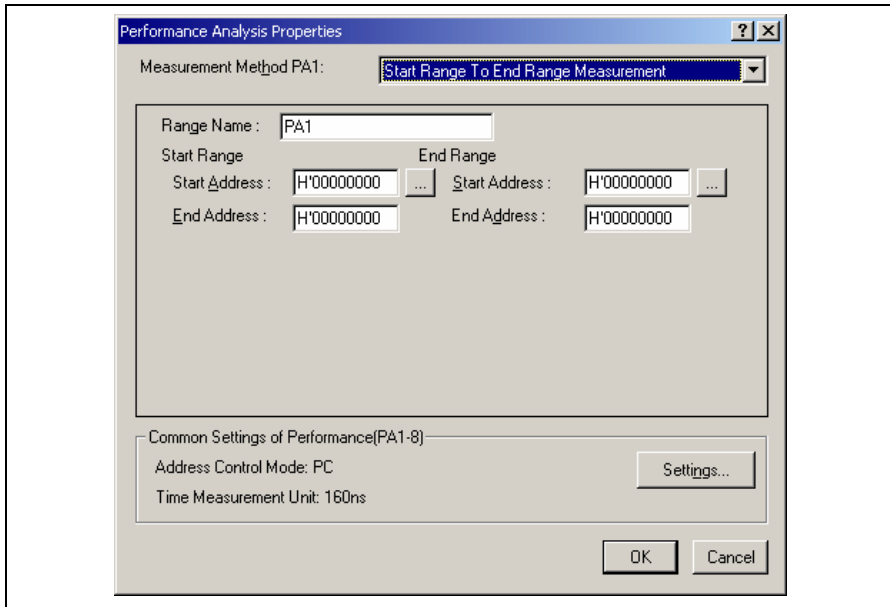

Figure 5.63 Start Range To End Range Measurement Settings

- [Range Name]: The name of the range to be measured
- [Start Range]: The start range for the Start Range To End Range Measurement
- [Start Address]: Start address
- [End Address]: End address
- [End Range]: The end range for the Start Range To End Range Measurement
- [Start Address]: Start address
- [End Address]: End address

Starts measurement with a detected prefetch cycle in the specified start address range, and then stops with a detected prefetch cycle in the specified end address range. The execution count is incremented every time the program passes the end address range.

(4) Access Count Of Specified Range Measurement

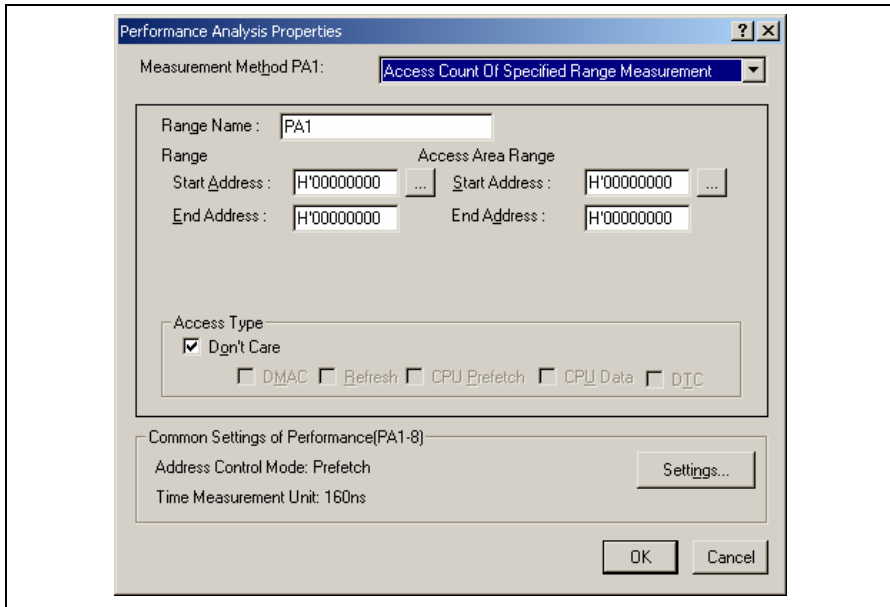

Figure 5.64 Access Count Of Specified Range Measurement Settings

[Range Name]: The name of the range to be measured

[Range]: The range for the Access Count Of Specified Range Measurement

[Start Address]: Start address

[End Address]: End address

[Access Area Range]: The access range for the Access Count Of Specified Range Measurement

[Start Address]: Start address

[End Address]: End address

[Access Type]: The bus cycle on the access range to be measured

Measures the number of times the range specified as the access range is accessed from the range specified by the start and end addresses. The execution count in the range is measured with Time Of Specified Range Measurement mode.

Note: Available bus cycle conditions vary according to the emulator in use. For details, refer to section 5.7.4, Signals to Indicate Bus States and Areas.

(5) Called Count Of Specified Range Measurement

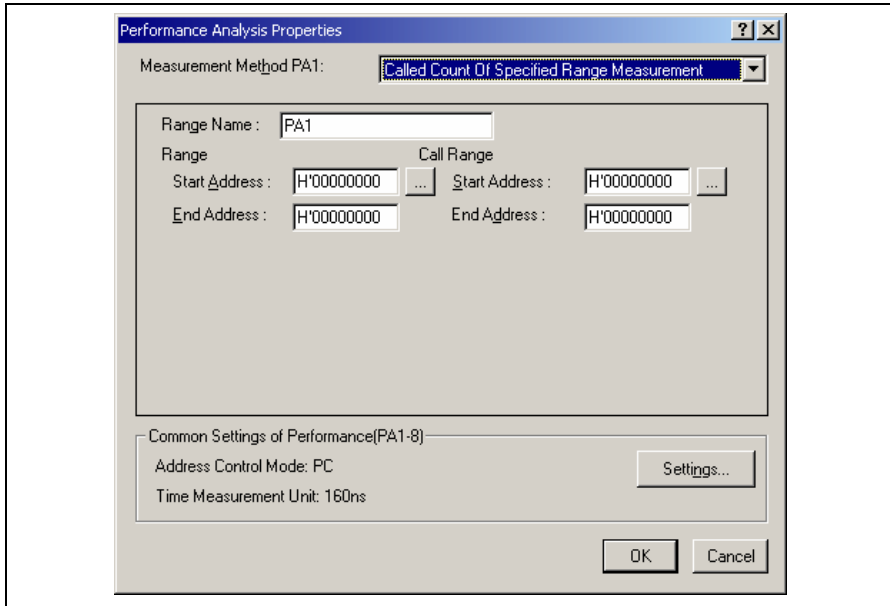

Figure 5.65 Called Count Of Specified Range Measurement Settings

[Range Name]: The name of the range to be measured

[Range]: The range for the Called Count Of Specified Range Measurement

[Start Address]: Start address

[End Address]: End address

[Call Range]: The range for the Called Count Of Specified Range Measurement. As the call range, specify the start and end addresses of the selected subroutine.

[Start Address]: Start address

[End Address]: End address

Measures the number of times the range specified as the call range is called from the range specified by the start and end addresses. The execution time in the specified range can be measured with Time Of Specified Range Measurement mode. As the call range, specify the start and end addresses of the selected subroutine.

5.9.3 Selecting the Address Detection Mode and Resolution

In measurement of hardware performance, there are two types of address detection modes: prefetch address detection mode and PC address detection mode. Select the appropriate address detection mode according to the measurement mode in use. The resolution can also be selected here.

To select an address detection mode and resolution, click the [Settings...] button on the [Performance Analysis Properties] dialog box. The [Common Settings of Performance(PA1-8)] dialog box will be displayed.

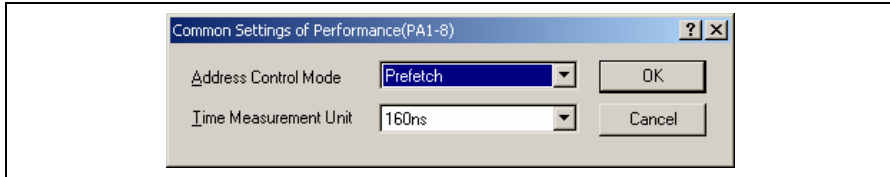

Figure 5.66 [Common Settings of Performance(PA1-8)] Dialog Box

- [Address Control Mode]: Select the method to detect addresses for the rate of execution time.
- PC: PC address detection mode
 - Prefetch: Prefetch address detection mode
- [Time Measurement Unit]: Select the timer resolution to be used for measurement from 160ns, 40ns, 20ns, or Target. The timer for execution time measurement has a 40-bit counter. At 20 ns the maximum time that can be measured is about six hours, and at 160 μ s the maximum time is about two days. When the counter overflows, "Timer Overflow" is displayed as the result of measurement. When Target is selected, the counter is incremented by an input clock. The result of measurement is displayed as 10 digits in hexadecimal.

Select the prefetch address detection mode in Access Count Of Specified Range Measurement, and PC address detection mode in other measurement modes. Otherwise, the result of the measurement will be incorrect.

5.9.4 Starting Performance Data Acquisition

Executing the user program clears the result of previous measurement and automatically starts measuring the rate of execution time according to the conditions that have been set. Stopping the user program displays the result of measurement in the [Performance Analysis] window.

5.9.5 Deleting a Measurement Condition

Select [Reset] from the popup menu with a measurement condition selected to delete the condition.

5.9.6 Deleting All Measurement Conditions

Choose [Reset All] from the popup menu to delete all the conditions that have been set.

Section 6 Tutorial

6.1 Introduction

The following describes the main functions of the emulator by using a tutorial program.

The tutorial program is based on the C++ program that sorts ten random data items in ascending or descending order. The tutorial program performs the following actions:

- The `main` function repeatedly calls the `tutorial` function to repeat sorting.
- The `tutorial` function generates random data to be sorted and calls the `sort` and `tutorial` functions in order.
- The `sort` function enters the array where the random data generated by the `tutorial` function are stored, and sorts them in ascending order.
- The `change` function then sorts the array, which was sorted in ascending order by the `sort` function, in descending order.

The file `tutorial.cpp` contains source code for the tutorial program. The file `Tutorial.abs` is a compiled load module in the Dwarf2 format.

- Notes:
1. After recompilation, the addresses may differ from those given in this section.
 2. This section describes general usage examples for the emulator. For the specifications of particular products, refer to section 8, Software Specifications Specific to This Product, or the online help.
 3. The operation address of `Tutorial.abs` attached to each product differs according to products. Replace the address used in this section with the relevant address in each product after checking that it is placed on the corresponding line of the source program.
 4. In this tutorial, the H8S/2646 E6000 emulator is taken as an example. File paths or the appearance of figures differs according to products.

6.2 Running the High-performance Embedded Workshop

Open a workspace by following the procedure listed in section 4.1.3, Selecting an Existing Workspace.

Select the following directory:

OS installation drive \Workspace\Tutorial\E6000\2646

Note: The file path differs depending on the product. Refer to section 8.2.4, Environment for Execution of the Tutorial Program.

Then select the file indicated below.

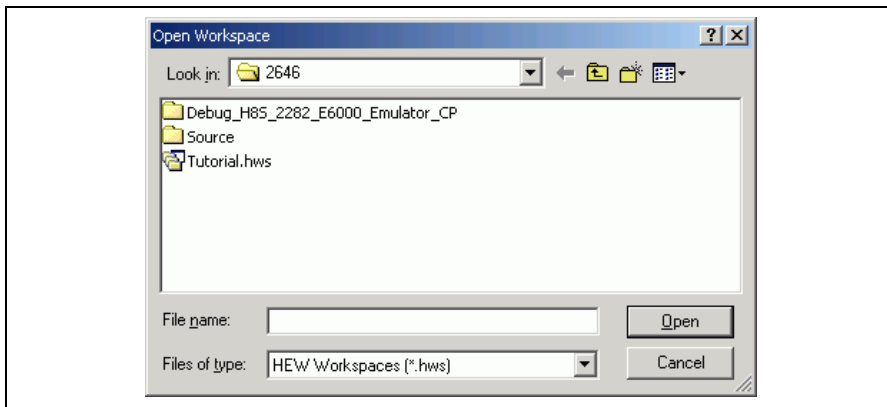

Figure 6.1 [Open Workspace] Dialog Box

Opening this workspace automatically connects the emulator.

6.3 Downloading the Tutorial Program

6.3.1 Downloading the Tutorial Program

Download the object program to be debugged.

- Select [Download module] from the popupmenu opened by clicking the right-hand mouse button on [Tutorial.abs] of [Download modules].

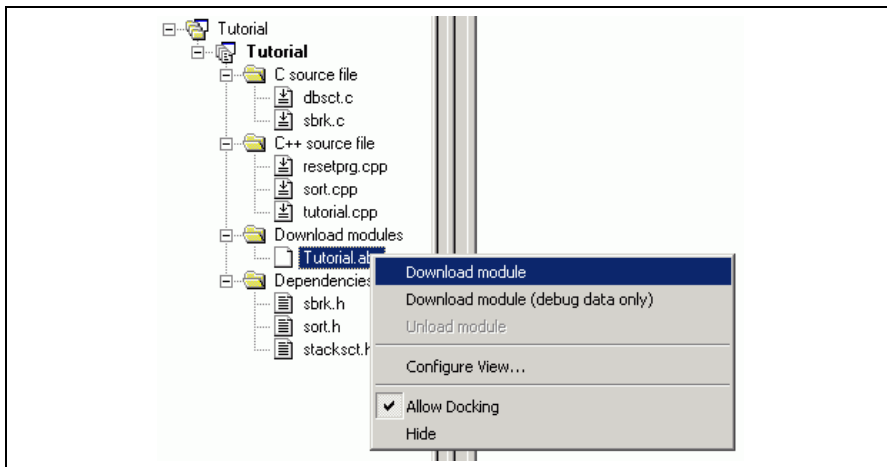

Figure 6.2 Downloading the Tutorial Program

6.3.2 Displaying the Source Program

The High-performance Embedded Workshop allows the user to debug a user program at the source level.

- Double-click [Tutorial.cpp] under [C++ source file].

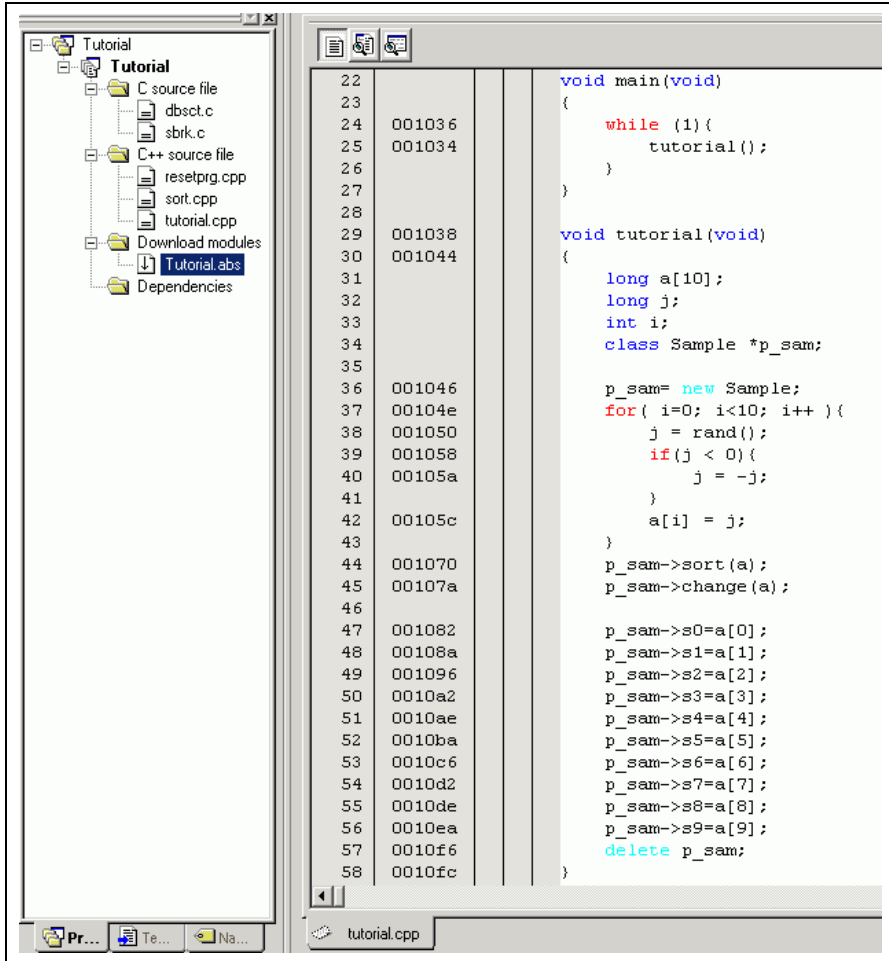

Figure 6.3 [Editor] Window (Displaying the Source Program)

- Select a font and size that are legible if necessary. For details, refer to the High-performance Embedded Workshop user's manual.

Initially the [Editor] window shows the start of the user program, but the user can use the scroll bar to scroll through the user program and look at the other statements.

6.4 Setting a Software Breakpoint

A software breakpoint is a simple debugging function.

The [Editor] window provides a very simple way of setting a software breakpoint at any point in a program. For example, to set a software breakpoint at the `sort` function call:

- Select by double-clicking the [S/W Breakpoints] column on the line containing the `sort` function call.

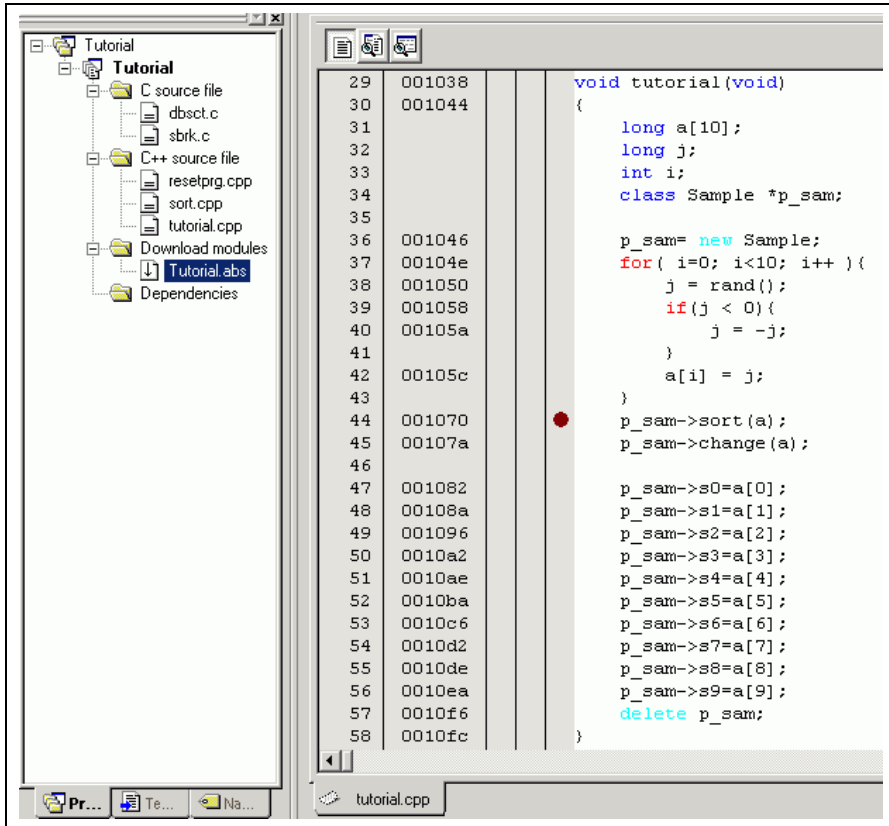

Figure 6.4 [Editor] Window (Setting a Software Breakpoint)

The symbol • will appear on the line containing the `sort` function. This shows that a software breakpoint has been set.

6.5 Setting Registers

Set a value of the program counter before executing the program.

- Select [Registers] from the [CPU] submenu of the [View] menu. The [Register] window is displayed.

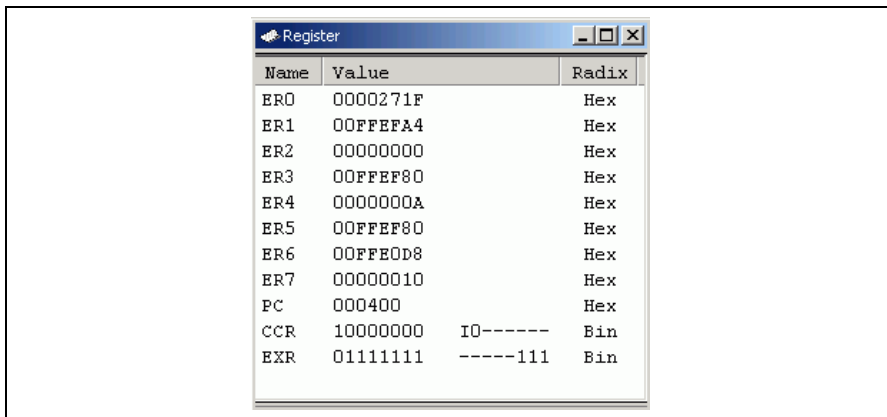

Figure 6.5 [Register] Window

- To change the value of the program counter (PC), double-click the value area in the [Register] window with the mouse. The following dialog box is then displayed, and the value can be changed. Set the program counter to H'00000400 in this tutorial program, and click the [OK] button.

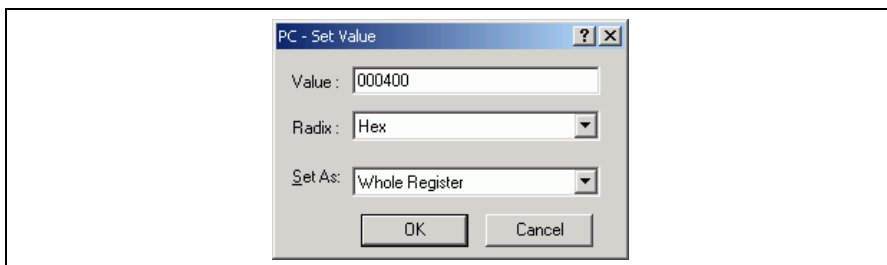

Figure 6.6 [Register] Dialog Box (PC)

6.6 Executing the Program

Execute the program as described in the following:

- To execute the program, select [Go] from the [Debug] menu, or click the [Go] button on the toolbar.

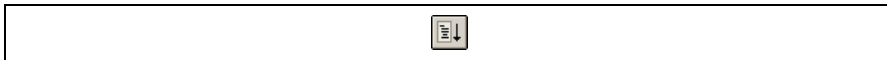

Figure 6.7 [Go] Button

While the program is executing, the current address bus value and the operating state of the MCU are displayed on the status bar.

The program will be executed up to the breakpoint that has been inserted, and an arrow will appear on the [S/W Breakpoints] column in the [Editor] window to show the position that the program has halted, with the message [Break = Software Break] in the status bar.

Note: When the source file is displayed after a break, a path of the source file may be inquired. The location of the source file is as follows:

OS installation drive \Workspace\Tutorial\E6000\2646\Source

The directory mentioned above cannot be specified depending on the version of the software. In such cases, specify the following directory instead.

High-performance Embedded Workshop installation destination directory
\Tools\Renesas\DebugComp\Platform\E6000\2646\Source

The file path differs depending on the product. If necessary, replace \2646 with another name.

```
29 001038 void tutorial(void)
30 001044 {
31 long a[10];
32 long j;
33 int i;
34 class Sample *p_sam;
35
36 p_sam= new Sample;
37 00104e for( i=0; i<10; i++ ){
38 001050     j = rand();
39 001058     if(j < 0){
40 00105a         j = -j;
41     }
42 00105c     a[i] = j;
43 }
44 001070     p_sam->sort(a);
45 00107a     p_sam->change(a);
46
47 p_sam->s0=a[0];
48 00108a p_sam->s1=a[1];
49 001096 p_sam->s2=a[2];
50 0010a2 p_sam->s3=a[3];
51 0010ae p_sam->s4=a[4];
52 0010ba p_sam->s5=a[5];
53 0010c6 p_sam->s6=a[6];
54 0010d2 p_sam->s7=a[7];
55 0010de p_sam->s8=a[8];
56 0010ea p_sam->s9=a[9];
57 0010f6 delete p_sam;
58 0010fc }
```

tutorial.cpp

Figure 6.8 [Editor] Window (Break Status)

The user can see the cause of the break that occurred last time in the [Status] window.

- Select [Status] from the [CPU] submenu of the [View] menu. After the [Status] window is displayed, open the [Platform] sheet, and check the Status of Cause of last break.

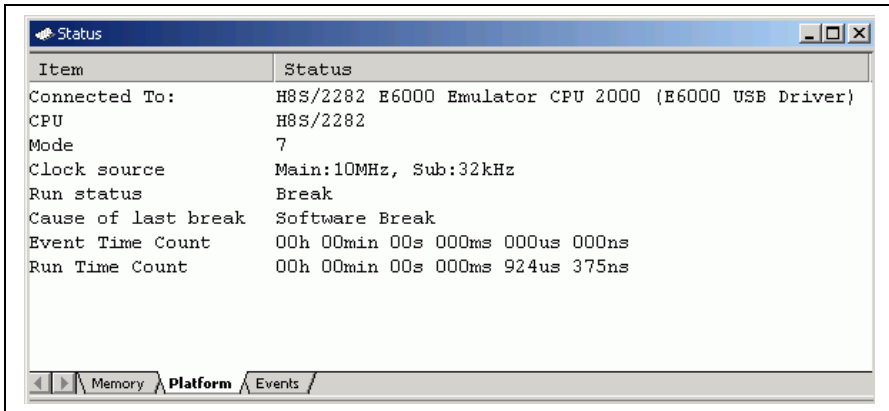

Figure 6.9 [Status] Window

Note: The items that can be displayed in this window differ depending on the product. For the items that can be displayed, refer to section 8, Software Specifications Specific to This Product, or the online help.

6.7 Reviewing Breakpoints

The user can see all the breakpoints set in the program in the [Event] window.

- Select [Eventpoints] from the [Code] submenu of the [View] menu. The [Event] window is displayed. Select the [Breakpoint] sheet.

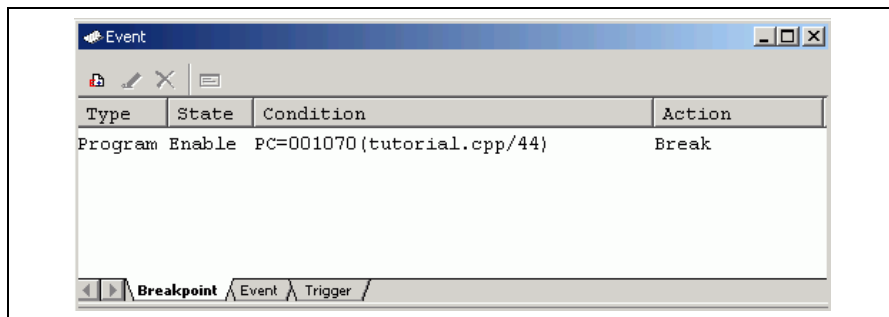

Figure 6.10 [Event] Window

The popup menu, opened by clicking the [Event] window with the right-hand mouse button, allows the user to set or change breakpoints, define new breakpoints, and delete, enable, or disable breakpoints.

6.8 Referring to Symbols

The [Label] window can be used to display the information on symbols in modules.

Select [Label] from the [Symbol] submenu of the [View] menu. The [Label] window is displayed so that the user can refer to the addresses of symbols in modules.

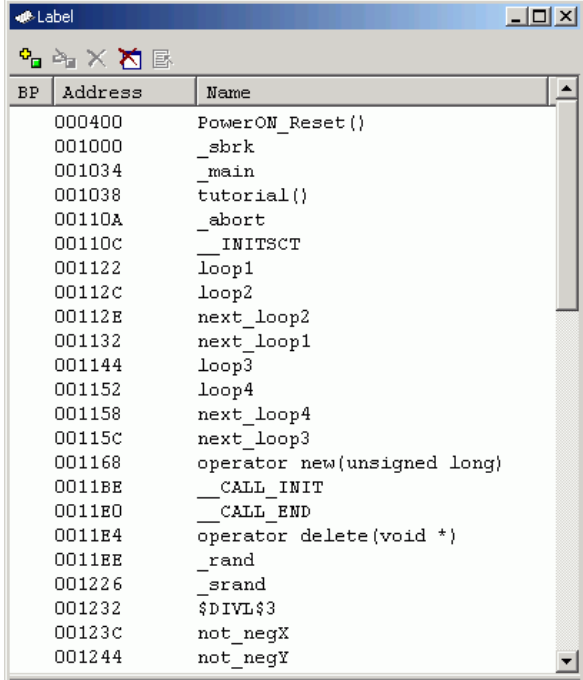

The screenshot shows a window titled "Label" with a standard Windows-style title bar and menu icons. The window contains a table with three columns: "BP", "Address", and "Name". The table lists various symbols and their corresponding memory addresses.

BP	Address	Name
	000400	PowerON_Reset()
	001000	_sbrk
	001034	_main
	001038	tutorial()
	00110A	_abort
	00110C	_INIT\$CT
	001122	loop1
	00112C	loop2
	00112E	next_loop2
	001132	next_loop1
	001144	loop3
	001152	loop4
	001158	next_loop4
	00115C	next_loop3
	001168	operator new(unsigned long)
	0011BE	__CALL_INIT
	0011E0	__CALL_END
	0011E4	operator delete(void *)
	0011EE	_rand
	001226	_srand
	001232	\$_DIVL\$3
	00123C	not_negX
	001244	not_negY

Figure 6.11 [Label] Window

6.9 Viewing Memory

When the label name is specified, the user can view the memory contents that the label has been registered in the [Memory] window. For example, to view the memory contents corresponding to `_main` in byte size:

- Select [Memory ...] from the [CPU] submenu of the [View] menu or click the [View Memory] toolbar button (🔍) to open the [Display Address] dialog box. Enter `_main` in the [Display Address] edit box.

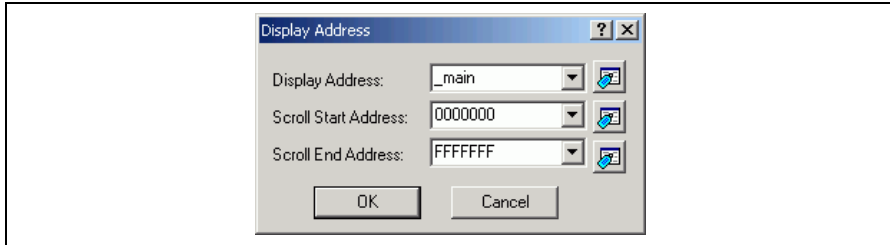

Figure 6.12 [Display Address] Dialog Box

- Click the [OK] button. The [Memory] window showing the selected area of memory is displayed.

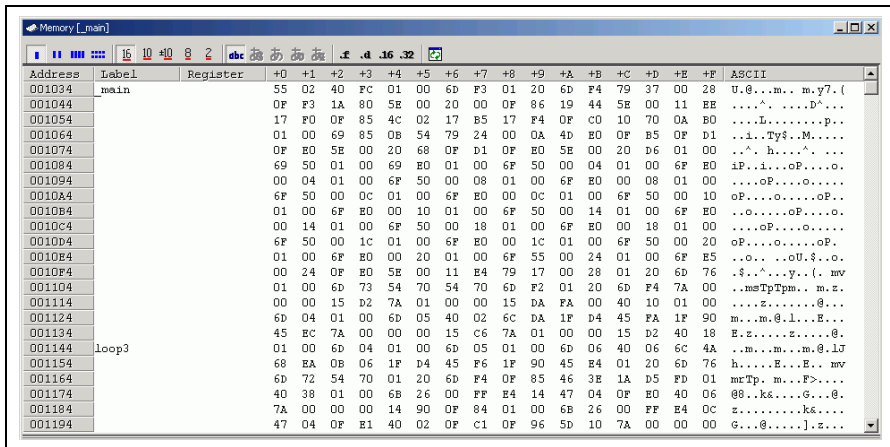

Figure 6.13 [Memory] Window

6.10 Watching Variables

As the user steps through a program, it is possible to watch that the values of variables used in the user program are changed. For example, set a watch on the long-type array `a` declared at the beginning of the program, by using the following procedure:

- Click the left of displayed array `a` in the [Editor] window to position the cursor.
- Select [Instant Watch...] with the right-hand mouse button.

The following dialog box will be displayed.

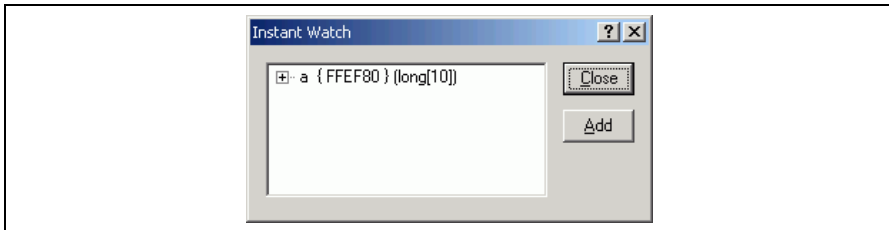

Figure 6.14 [Instant Watch] Dialog Box

- Click the [Add] button to add a variable to the [Watch] window.

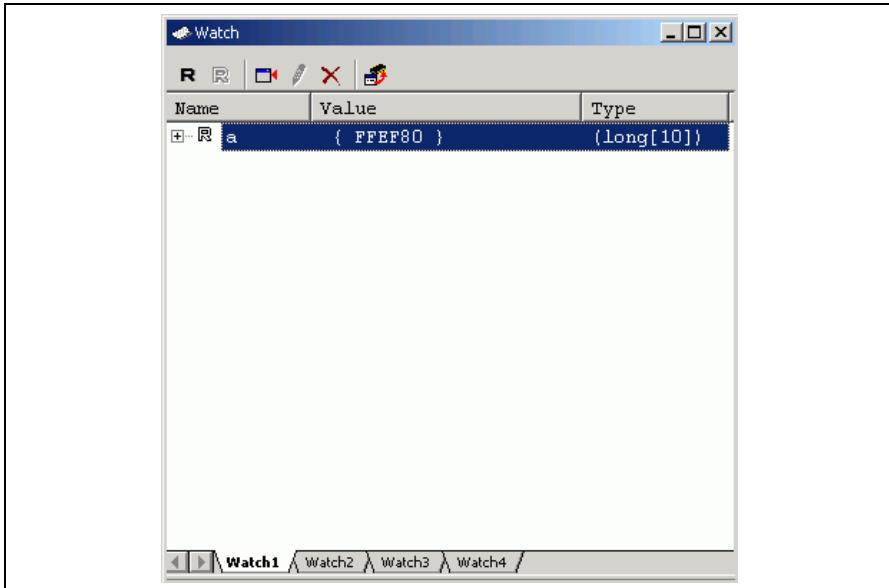

Figure 6.15 [Watch] Window (Displaying the Array)

The user can also add a variable to the [Watch] window by specifying its name.

- Click the [Watch] window with the right-hand mouse button and select [Add Watch...] from the popup menu.

The following dialog box will be displayed.

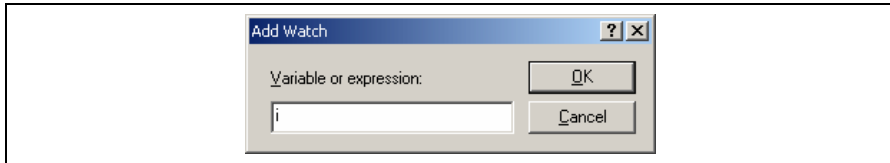

Figure 6.16 [Add Watch] Dialog Box

- Input variable `i` to [Variable or expression] edit box and click the [OK] button.

The [Watch] window will now also show the int-type variable `i`.

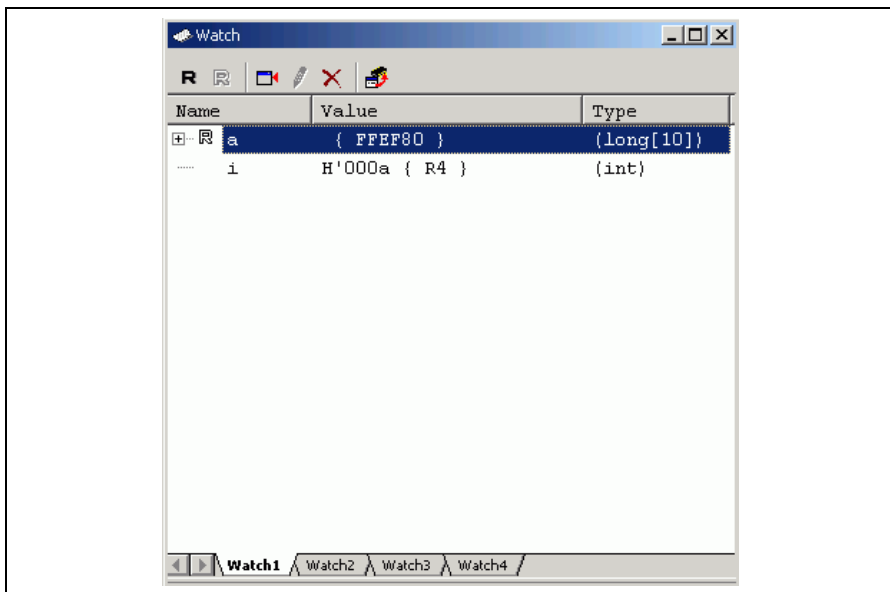

Figure 6.17 [Watch] Window (Displaying the Variable)

The user can click mark '+' at the left side of array a in the [Watch] window to watch all the elements.

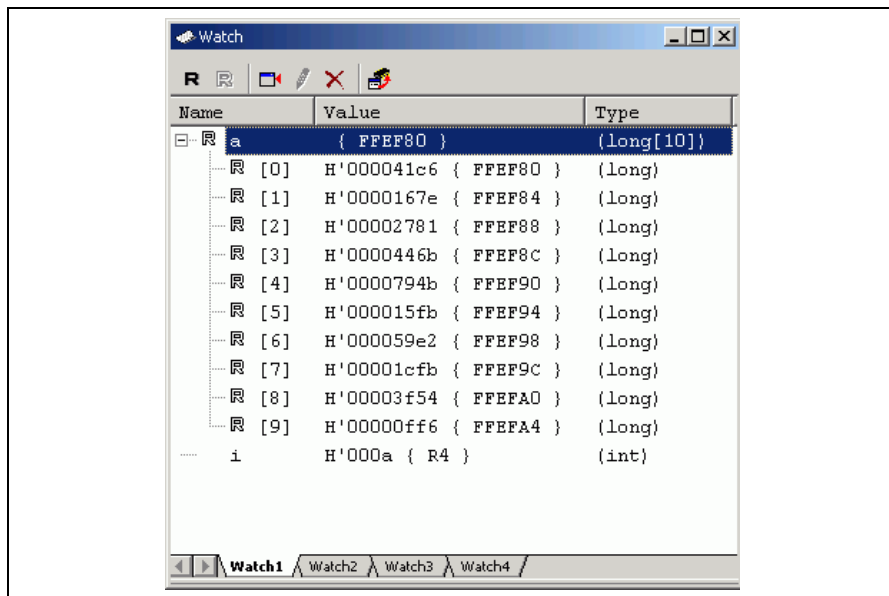

Figure 6.18 [Watch] Window (Displaying Array Elements)

6.11 Displaying Local Variables

The user can display local variables in a function using the [Locals] window. For example, we will examine the local variables in the `tutorial` function, which declares four local variables: `a`, `j`, `i`, and `p_sam`.

- Select [Locals] from the [Symbol] submenu of the [View] menu. The [Locals] window is displayed.

The [Locals] window shows the local variables in the function currently pointed to by the program counter, along with their values. Note, however, that the [Locals] window is initially empty because local variables are yet to be declared.

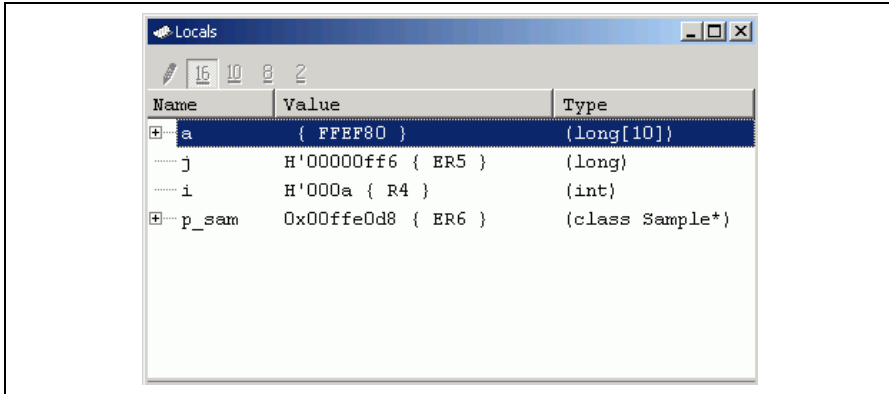

Figure 6.19 [Locals] Window

- Click mark '+' at the left side of array `a` in the [Locals] window to display the elements.
- Refer to the elements of array `a` before and after the execution of the `sort` function, and confirm that random data is sorted in descending order.

6.12 Stepping Through a Program

The High-performance Embedded Workshop provides a range of step menu commands that allow efficient program debugging.

Table 6.1 Step Option

Menu Command	Description
Step In	Executes each statement, including statements within functions.
Step Over	Executes a function call in a single step.
Step Out	Steps out of a function, and stops at the statement following the statement in the program that called the function.
Step...	Steps the specified times repeatedly at a specified rate.

6.12.1 Executing the [Step In] Command

The [Step In] command steps into the called function and stops at the first statement of the called function.

- To step through the `sort` function, select [Step In] from the [Debug] menu, or click the [Step In] button in the toolbar.

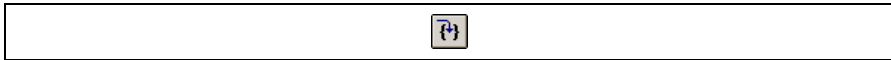

Figure 6.20 [Step In] Button

```

11 002000 Sample::Sample()
12 002006 {
13 00201c     s0=0;
14 002026     s1=0;
15 00202c     s2=0;
16 002032     s3=0;
17 002038     s4=0;
18 00203e     s5=0;
19 002044     s6=0;
20 00204a     s7=0;
21 002050     s8=0;
22 002056     s9=0;
23 002060 }
24
25 002068 void Sample::sort(long *a)
26 002070 {
27     long t;
28     int i, j, k, gap;
29
30     gap = 5;
31     while( gap > 0 ){
32         for( k=0; k<gap; k++){
33             for( i=k+gap; i<10; i=i+gap ){
34                 for( j=i-gap; j>=k; j=j-gap){
35                     if(a[j]>a[j+gap]){
36                         t = a[j];
37                         a[j] = a[j+gap];
38                         a[j+gap] = t;
39                     }
40                     else
41                         break;
42                 }
43             }
44         }
45         gap = gap/2;
46     }
47 }

```

tutorial.cpp sort.cpp

Figure 6.21 [Editor] Window (Step In)

- The highlighted line moves to the first statement of the `sort` function in the [Editor] window.

6.12.2 Executing the [Step Out] Command

The [Step Out] command steps out of the called function and stops at the next statement of the calling statement in the main function.

- To step out of the `sort` function, select [Step Out] from the [Debug] menu, or click the [Step Out] button in the toolbar.



Figure 6.22 [Step Out] Button

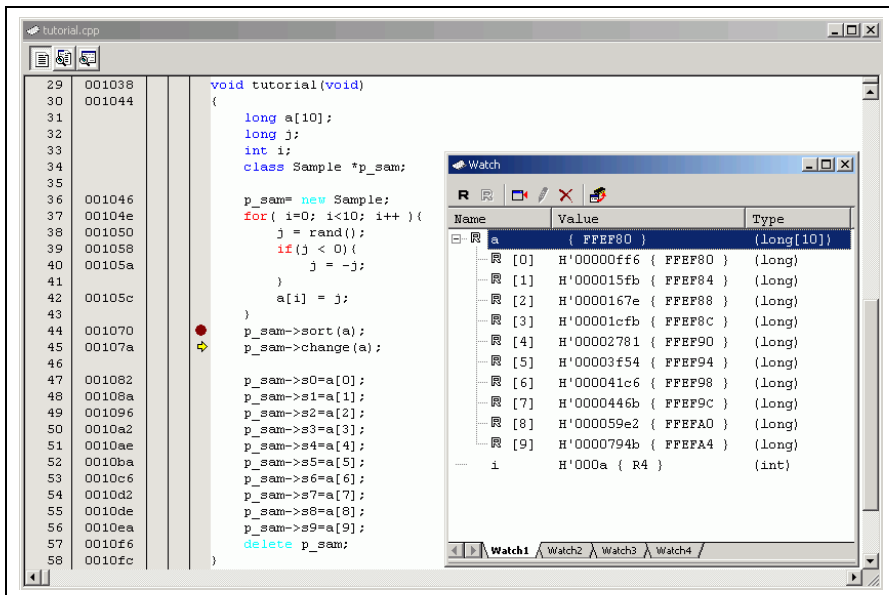

Figure 6.23 [High-performance Embedded Workshop] Window (Step Out)

The data of variable `a` displayed in the [Watch] window is sorted in ascending order.

6.12.3 Executing the [Step Over] Command

The [Step Over] executes a function call as a single step and stops at the next statement of the main program.

- To step through all statements in the change function at a single step, select [Step Over] from the [Debug] menu, or click the [Step Over] button in the toolbar.



Figure 6.24 [Step Over] Button

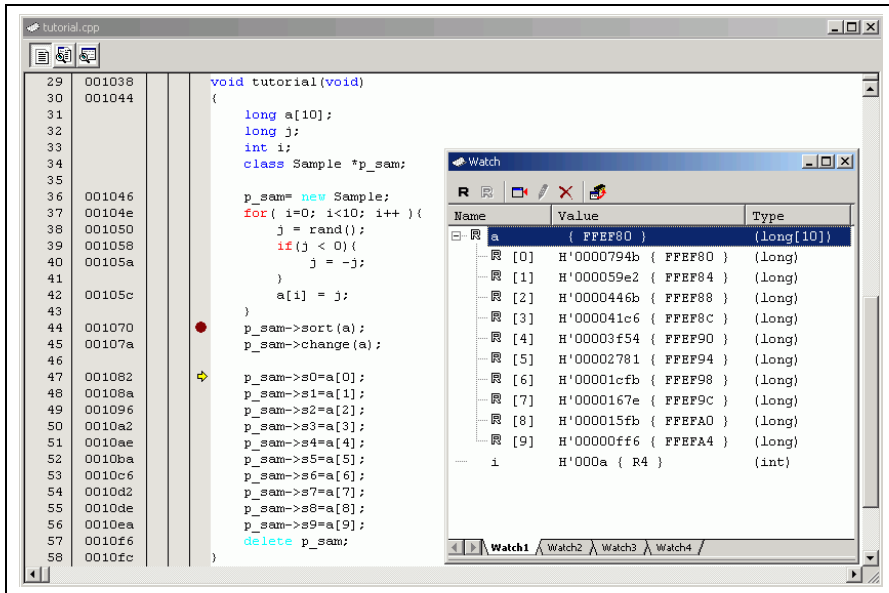

Figure 6.25 [High-performance Embedded Workshop] Window (Step Over)

6.13 Forced Breaking of Program Executions

The High-performance Embedded Workshop can force a break in the execution of a program.

- Cancel all the breaks.
- To execute the remaining sections of the tutorial function, select [Go] from the [Debug] menu or the [Go] button on the toolbar.

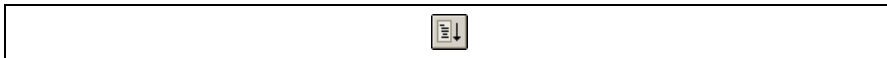

Figure 6.26 [Go] Button

- The program goes into an endless loop. To force a break in execution, select [Halt] from the [Debug] menu or the [Stop] button on the toolbar.

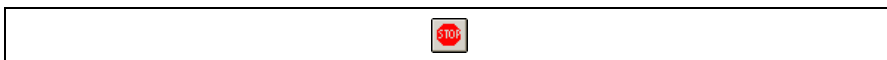

Figure 6.27 [Stop] Button

6.14 Resetting the MCU

Resetting the MCU initializes the internal I/O registers and makes the program counter jump to the address set in the reset vector.

To reset the MCU, select [Reset CPU] from the [Debug] menu or the [Reset CPU] button on the toolbar.

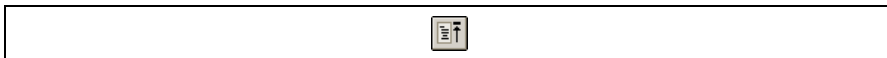

Figure 6.28 [Reset CPU] Button

To execute the program from the reset vector, select [Reset Go] from the [Debug] menu or the [Reset Go] button on the toolbar.

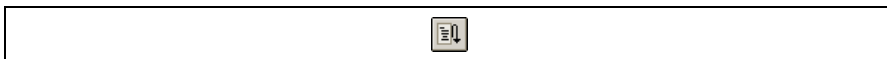

Figure 6.29 [Reset Go] Button

Note: This tutorial program is executable from the reset vector.

6.15 Break Function

The emulator's break functions are of two types: software breaks and breaks at event points. software breakpoints and event points are set in the High-performance Embedded Workshop's [Event] window.

An overview and setting of the break function are described below.

6.15.1 Software Break Function

The emulator can set up to 256 software breakpoints.

- Select [Eventpoints] from the [Code] submenu of the [View] menu. The [Event] window is displayed.
- Select the [Breakpoint] sheet.

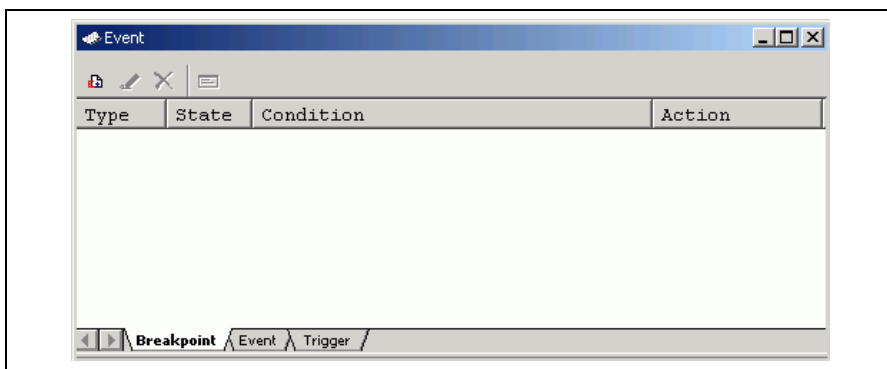

Figure 6.30 [Event] Window (Before Setting a Software Breakpoint)

- Click the [Event] window with the right-hand mouse button and select [Add...] from the popup menu.
- The [Breakpoint/Event Properties] dialog box is displayed.

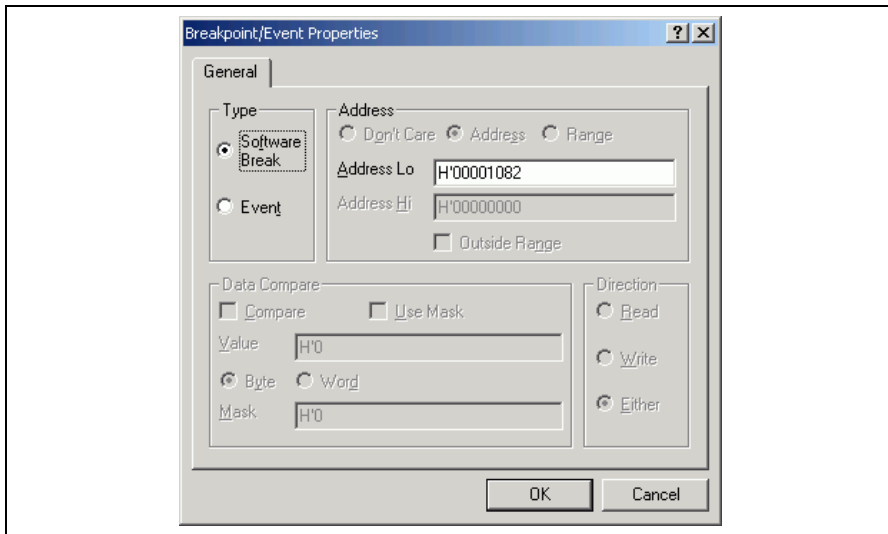

Figure 6.31 [Breakpoint/Event Properties] Dialog Box

- Check the [Software Break] radio button in the [Type] group box.
- Use the [Editor] window to refer to the address on the line that has 'p_sam->s0=a[0];' within the tutorial function and enter this address in the [Address Lo] edit box of the [Address] group box. In this example, enter **H'00001082**.

Note: This dialog box differs according to the product. For the items of each product, refer to section 8, Software Specifications Specific to This Product, or the online help.

- Click the [OK] button.

The software breakpoint that has been set is displayed in the [Event] window.

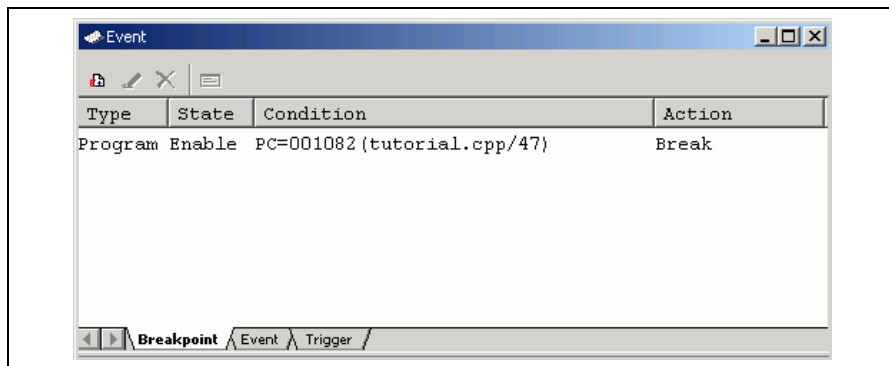

Figure 6.32 [Event] Window (Software Breakpoint Setting)

Note: The items that can be displayed in this window differ depending on the product. For the items that can be displayed, refer to section 8, Software Specifications Specific to This Product, or the online help.

- Close the [Event] window.
- To stop the tutorial program at the breakpoint, select [Reset Go] from the [Debug] menu.

The program runs until it stops at the breakpoint that has been set.

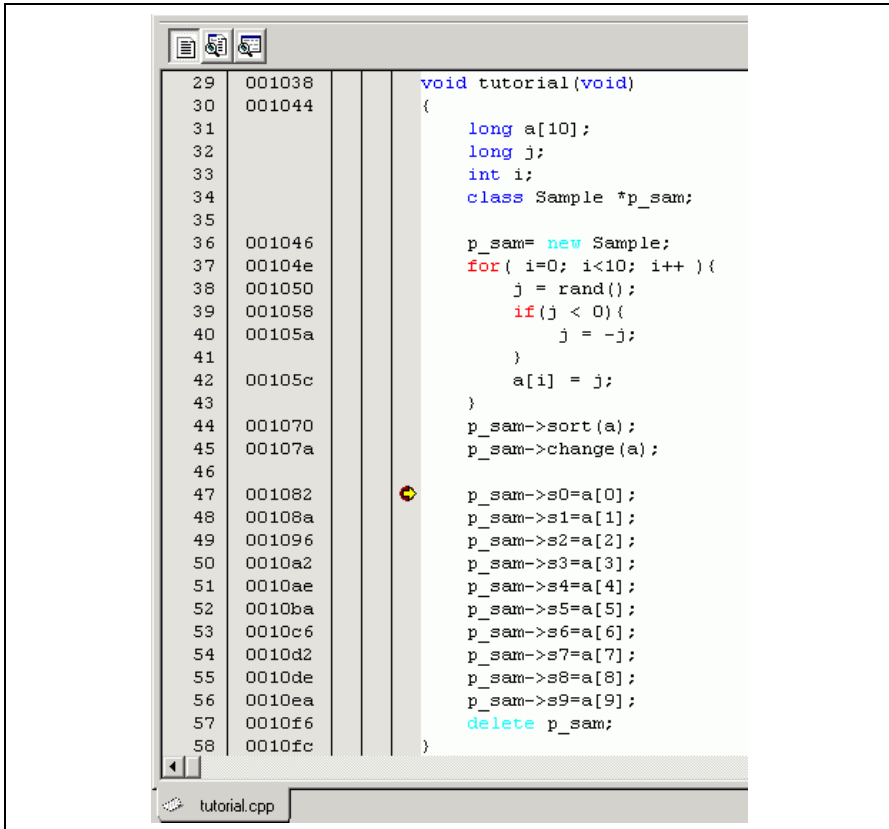
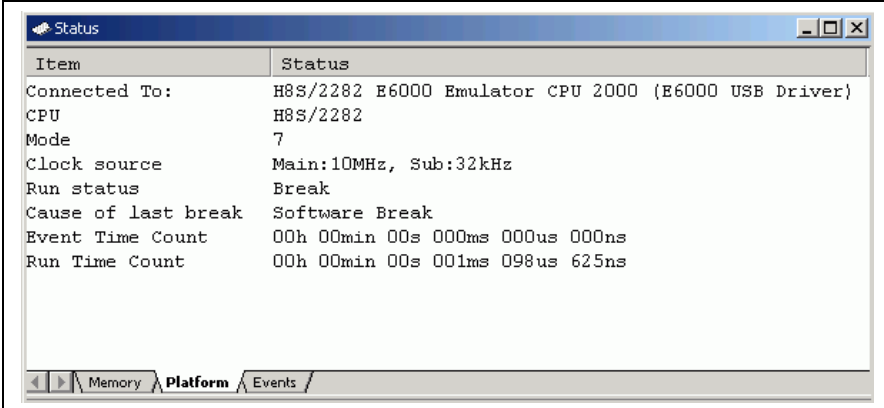

Figure 6.33 [Editor] Window at Execution Stop (Software Break)

The [Status] window displays the following contents:



The screenshot shows a window titled "Status" with a table of system information. The table has two columns: "Item" and "Status". The data is as follows:

Item	Status
Connected To:	H8S/2282 E6000 Emulator CPU 2000 (E6000 USB Driver)
CPU	H8S/2282
Mode	7
Clock source	Main:10MHz, Sub:32kHz
Run status	Break
Cause of last break	Software Break
Event Time Count	00h 00min 00s 000ms 000us 000ns
Run Time Count	00h 00min 00s 001ms 098us 625ns

At the bottom of the window, there are three tabs: "Memory", "Platform" (which is selected), and "Events".

Figure 6.34 Displayed Contents of the [Status] Window (Software Break)

Note: The items that can be displayed in this window differ depending on the product. For the items that can be displayed, refer to section 8, Software Specifications Specific to This Product, or the online help.

6.15.2 Breaking Execution at Event Points

Setting up of an event point on event channel 1 (Ch1) such that a break is triggered when the event point's conditions have been satisfied five times is explained as an example of the use of event points.

- Select [Eventpoints] from the [Code] submenu of the [View] menu. The [Event] window is displayed.
- The breakpoint that has been previously set must be deleted. Click the [Breakpoints] window with the right-hand mouse button and select [Delete All] from the popup menu to delete all the breakpoints that have been set.
- Click the [Event] tab.

Up to 12 event points (eight event channels and four range channels) can be set up as independent conditions. In this example, we are setting the condition for event channel 1.

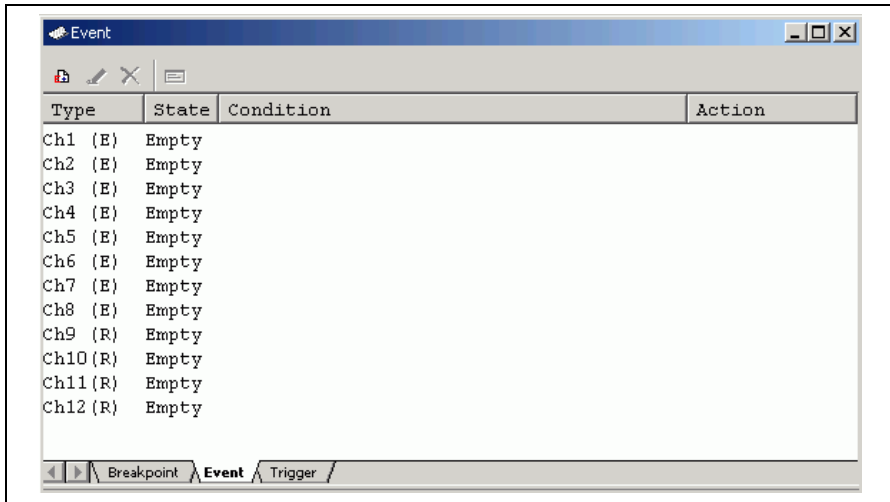

Figure 6.35 [Event] Window (Event Channel 1 [Ch1])

- Select the line for Ch1 in the [Event] window. Double-click on this line that is highlighted.
- The [Breakpoint/Event Properties] dialog box is displayed.
- Make the following settings in the boxes on the [General] page:
 - Select the [Event] radio button in the [Type] group box.
 - Select the [Address] radio button in the [Address] group box. Then use the [Editor] window to refer to the address on the line that has 'a[i]=j;' within the tutorial function and enter this address in the [Address Lo] edit box. In this example, enter `H'0000105c`.
- Enter `D'5` as the number of times the event condition is to be satisfied in the [Required number of event occurrences] edit box on the [Action] page.

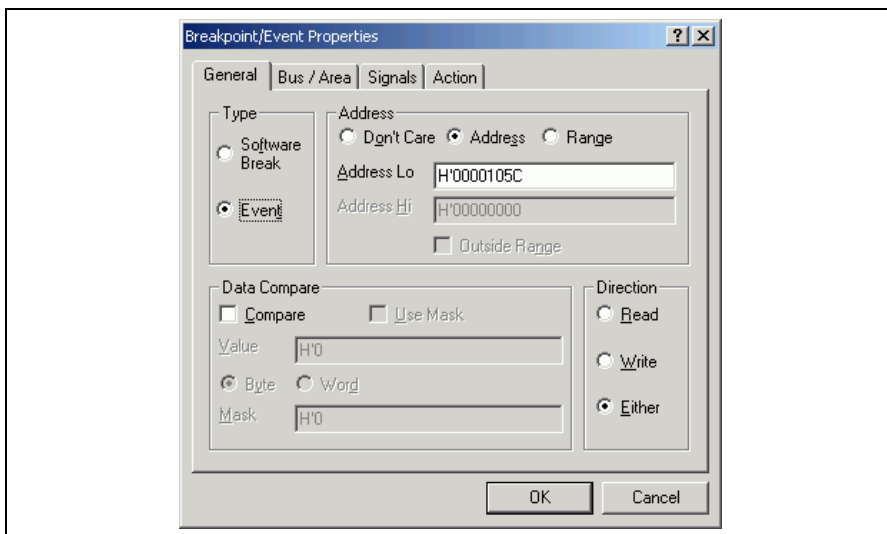

Figure 6.36 [General] Page ([Breakpoint/Event Properties] Dialog Box)

- Click the [OK] button. The [Event] window is displayed, as shown below.

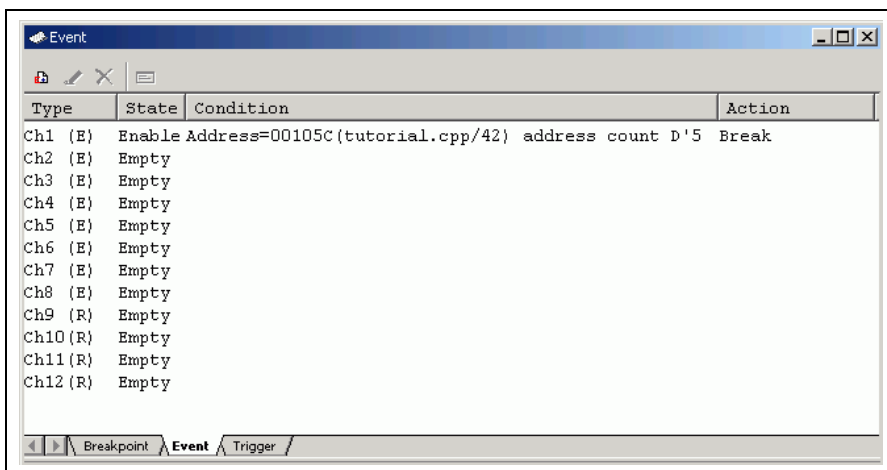
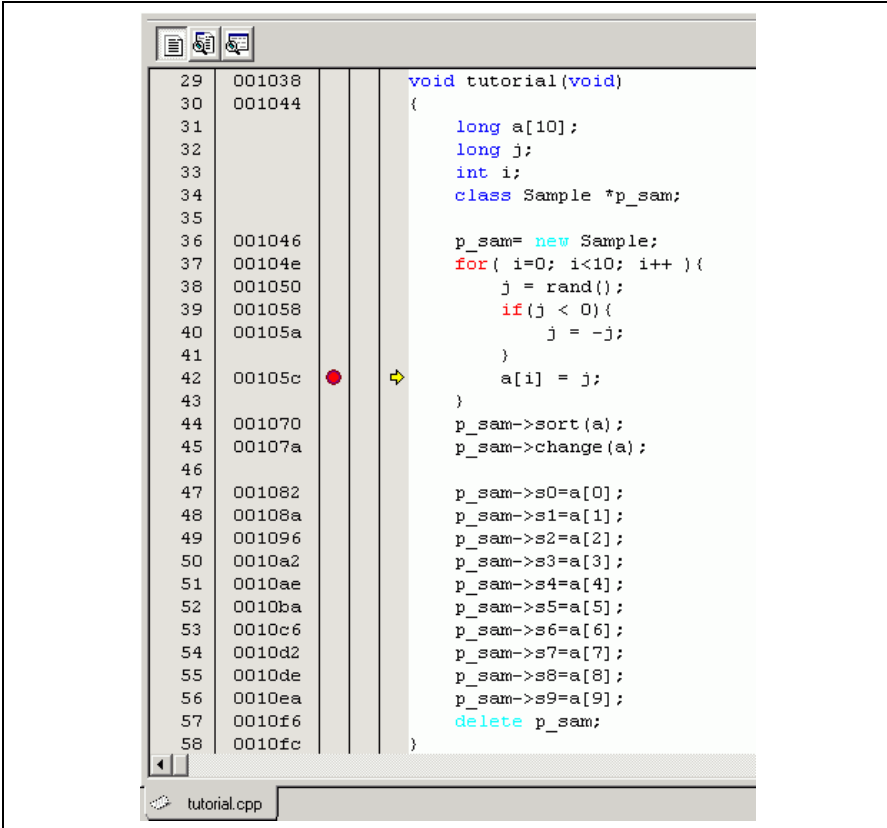

Figure 6.37 [Event] Window (Setting Completed)

Note: The items that can be displayed in this window differ depending on the product. For the items that can be displayed, refer to section 8, Software Specifications Specific to This Product, or the online help.

Select [Reset Go] from the [Debug] menu to stop the tutorial program at breakpoints.

The program runs then stops at the condition specified under Ch1.



```
29 001038 void tutorial(void)
30 001044 {
31     long a[10];
32     long j;
33     int i;
34     class Sample *p_sam;
35
36 001046     p_sam= new Sample;
37 00104e     for( i=0; i<10; i++ ){
38 001050         j = rand();
39 001058         if(j < 0){
40 00105a             j = -j;
41
42 00105c             a[i] = j;
43         }
44 001070     p_sam->sort( a);
45 00107a     p_sam->change( a);
46
47 001082     p_sam->s0=a[0];
48 00108a     p_sam->s1=a[1];
49 001096     p_sam->s2=a[2];
50 0010a2     p_sam->s3=a[3];
51 0010ae     p_sam->s4=a[4];
52 0010ba     p_sam->s5=a[5];
53 0010c6     p_sam->s6=a[6];
54 0010d2     p_sam->s7=a[7];
55 0010de     p_sam->s8=a[8];
56 0010ea     p_sam->s9=a[9];
57 0010f6     delete p_sam;
58 0010fc }
```

Figure 6.38 [Editor] Window at Execution Stop

The [Status] window displays the following contents.

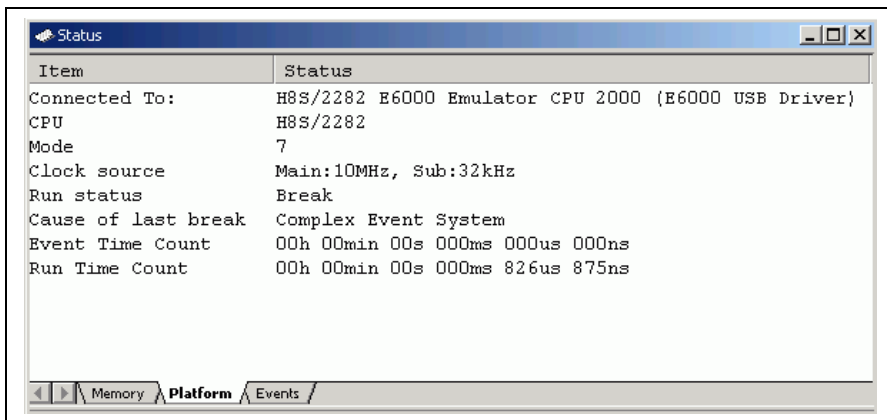

Figure 6.39 Displayed Contents of the [Status] Window

Refer to the [Watch] window for the value of variable *i*. The value is 4, indicating that the break occurred after the condition had been satisfied five times.

Note: The items that can be displayed in this window differ depending on the product. For the items that can be displayed, refer to section 8, Software Specifications Specific to This Product, or the online help.

Remove the event point. Clicking the right-hand mouse button on the [Event] window displays a popup menu. Select [Remove All] from this menu to remove all event points.

6.16 Trace Functions

The trace functions of the emulator use the realtime trace buffer, which is able to store the information on up to 32,768 bus cycles. The content of this buffer, which is constantly updated during execution, is displayed in the [Trace] window.

Select [Trace] from the [Code] submenu of the [View] menu to display the [Trace] window.

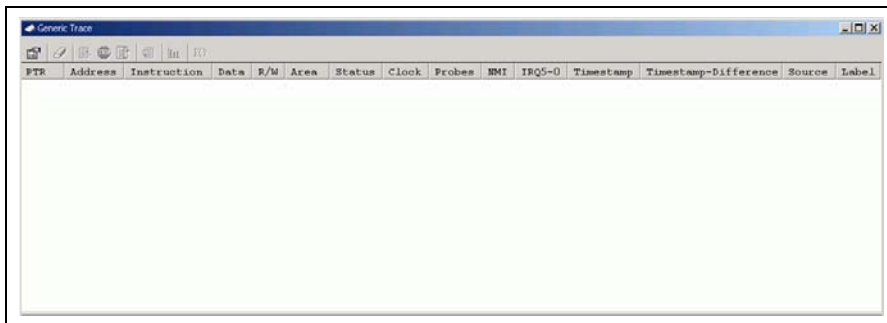

Figure 6.40 [Trace] Window

When trace information is displayed in the [Trace] window, clicking the right-hand mouse button on the [Trace] window displays a popup menu. Select [Clear] from this menu to clear the trace information.

The following sections give an overview of the trace functions and methods for setting them.

6.16.1 Displaying a Trace (when Time Stamping is not Available)

The method used to specify an address as an event condition for the tracing of read/write cycles and display the trace is described below.

- (1) Clicking the right-hand mouse button on the [Trace] window displays a popup menu. Select [Acquisition...] from this menu to display the [Trace Acquisition] dialog box.

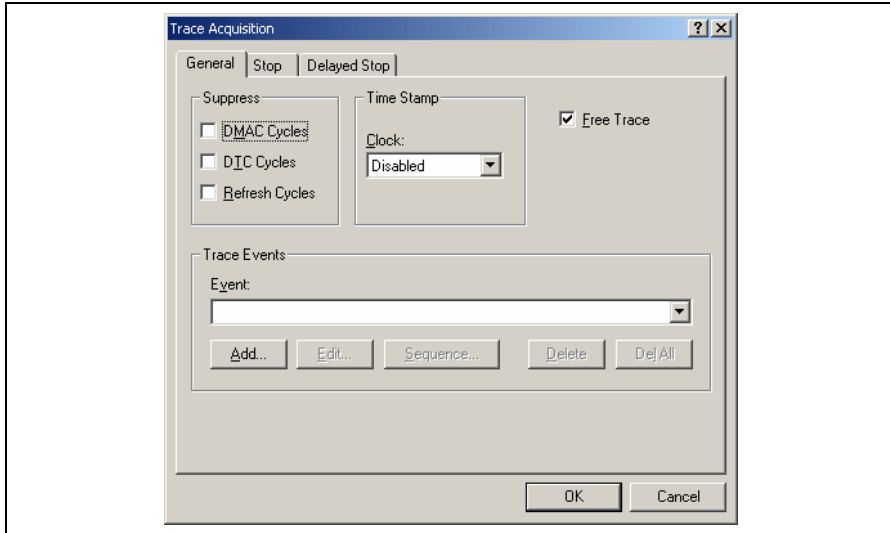

Figure 6.41 [Trace Acquisition] Dialog Box

- (2) Register an address as an event condition for trace acquisition. Click the [Add...] button in the [Trace Events] group box on the [General] page to display the [Breakpoint/Event Properties] dialog box.

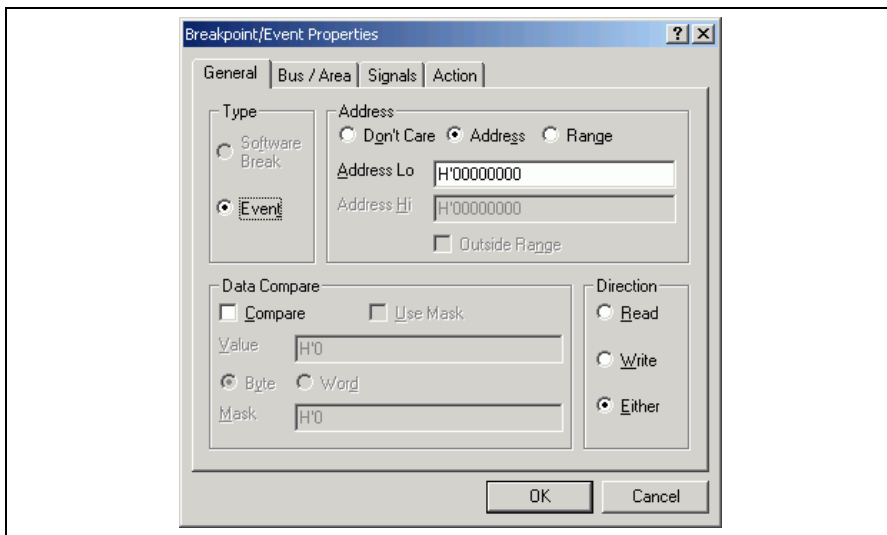

Figure 6.42 [Breakpoint/Event Properties] Dialog Box

- (3) Use the [Editor] window to refer to the address on the line that has 'a[i]=j;' within the tutorial function and enter this address in the [Address Lo] edit box of the [Address] group box on the [General] page of the [Breakpoint/Event Properties] dialog box. In this example, enter `H'0000105C`. This address has thus been set. Click the [OK] button to close the [Breakpoint/Event Properties] dialog box.

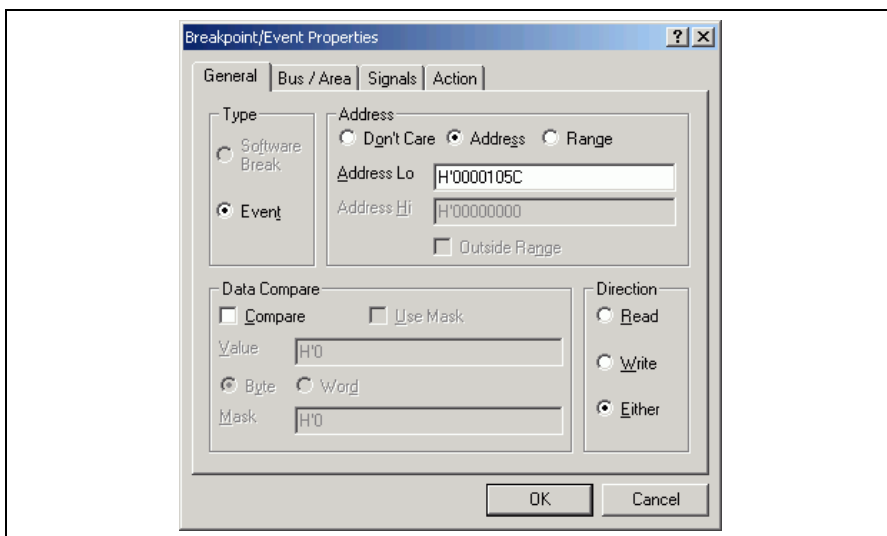

Figure 6.43 [Breakpoint/Event Properties] Dialog Box (after Setting an Event)

- (4) The event that has been set is now displayed in the [Event] combo box of the [Trace Events] group box on the [General] page of the [Trace Acquisition] dialog box.

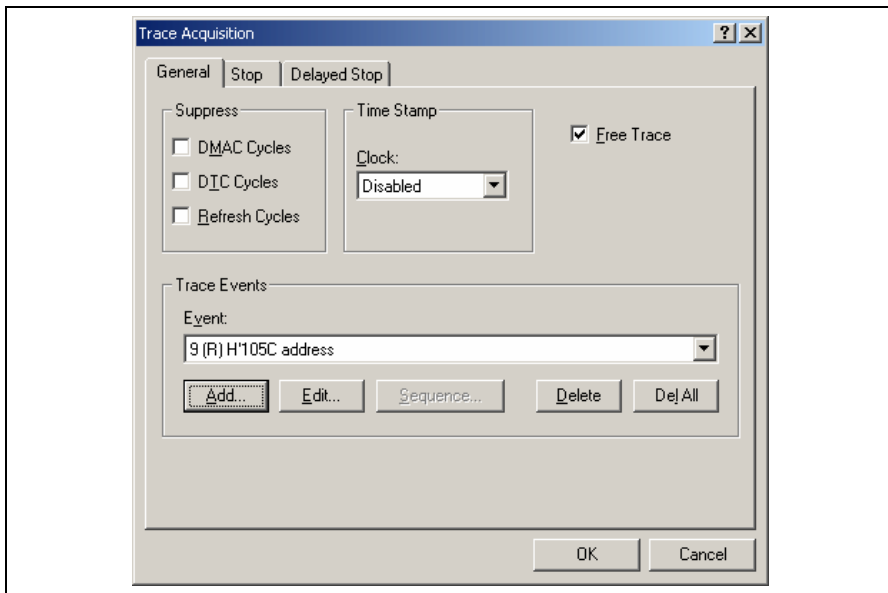

Figure 6.44 [Trace Acquisition] Dialog Box (Adding an Event)

- (5) To enable the event condition that has been set, uncheck the [Free Trace] check box on the [General] page. This will add pages [1] to [4] to the [Trace Acquisition] dialog box.

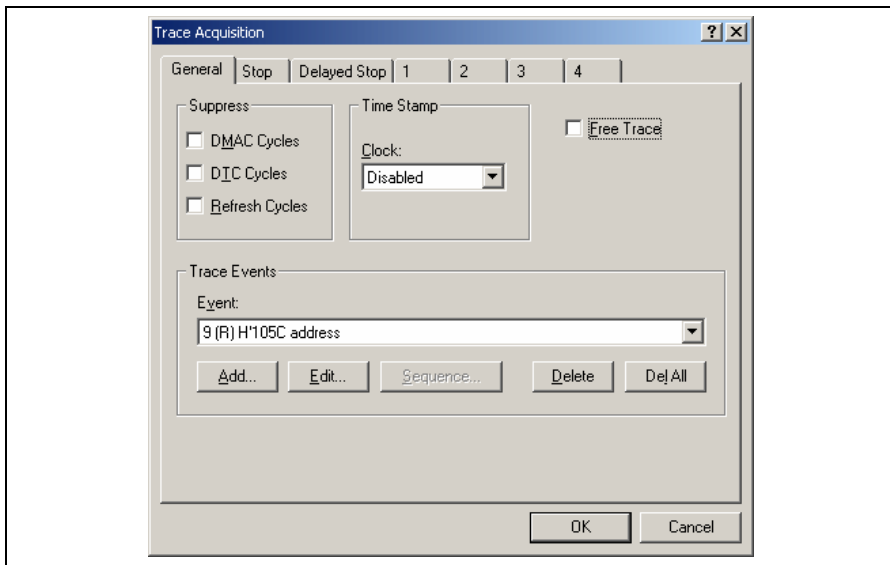

Figure 6.45 [Trace Acquisition] Dialog Box (Pages Added)

(6) Select page [1] and click the [Range] radio button in the [Conditions] group box. This will display the [Range Event] combo box and the [Edit...] button.

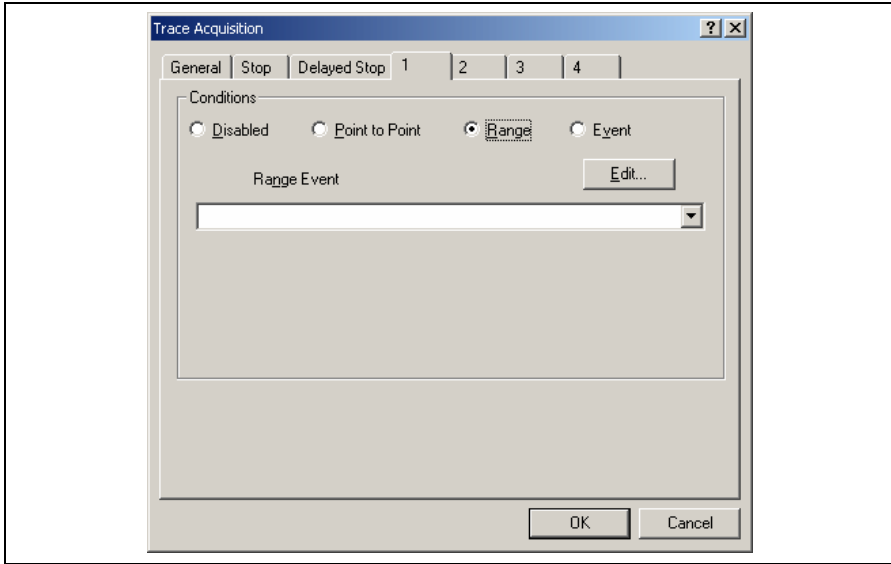

Figure 6.46 [Trace Acquisition] Dialog Box (Displaying Page [1])

- (7) Select the event you have registered from the [Range Event] combo box. The event is now enabled. Click the [OK] button to complete the trace setting.

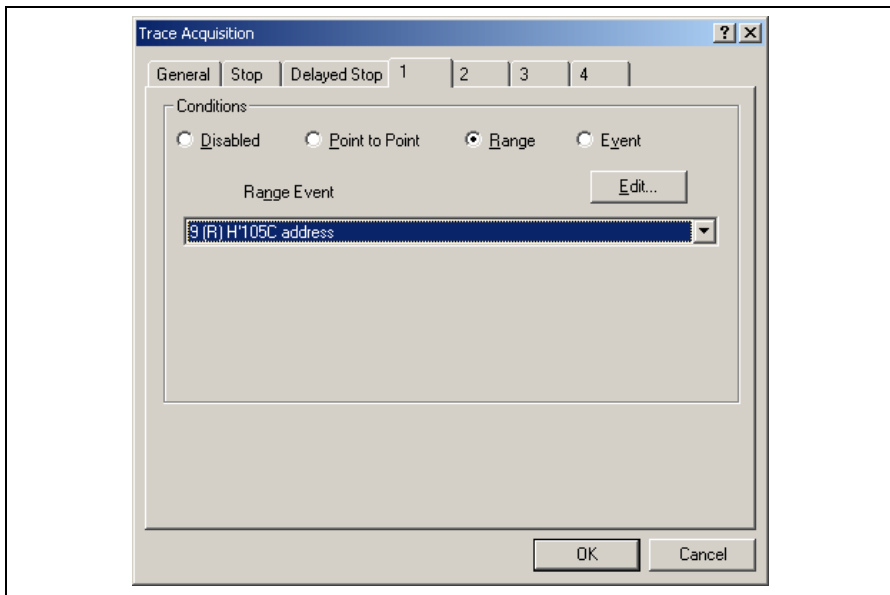

Figure 6.47 [Trace Acquisition] Dialog Box (Setting Completed)

- (8) Make the setting such that the break occurs after the instruction at the address on the line that has 'a[i]=j;' within the tutorial function (**H'000105C** in this example) has been executed five times (for details on this, refer to section 6.15.2, Breaking Execution at Event Points).
- (9) Select [Reset Go] from the [Debug] menu. Processing stops when the break condition is satisfied, and the [Trace] window then displays the following content.

PTR	Address	Instruction	Data	R/W	Area	Status	Clock	Probes	NMI	IRQ5-0	Source	Label
-00004	00105c	EXTS.L	ER4	17f4	RD	ROM	PROG	1	1111	1	111111	a[a] = j;
-00003	00105c	EXTS.L	ER4	17f4	RD	ROM	PROG	1	1111	1	111111	a[a] = j;
-00002	00105c	EXTS.L	ER4	17f4	RD	ROM	PROG	1	1111	1	111111	a[a] = j;
-00001	00105c	EXTS.L	ER4	17f4	RD	ROM	PROG	1	1111	1	111111	a[a] = j;
+00000	00105c	EXTS.L	ER4	17f4	RD	ROM	PROG	1	1111	1	111111	a[a] = j;

Figure 6.48 [Trace] Window (Displaying the Result)

If you have trouble viewing a column, drag the header (vertical) bars below the title bar to adjust the width of the column.

- (10) Remove the event points that have been set and clear the trace information. Click the right-hand mouse button on the [Event] window to display a popup menu. Select [Delete All] from this menu to remove all of the event points that have been set. Click the right-hand mouse button on the [Trace] window to display a further popup menu. Select [Clear] from this menu to clear the trace information.

6.16.2 Displaying a Trace (when Time Stamping is Available)

The following procedure is for obtaining and displaying, with time stamps, trace information on cycles of writing to memory locations in the specified address range.

- (1) Clicking the right-hand mouse button on the [Trace] window displays a popup menu. Select [Acquisition...] from this menu to display the [Trace Acquisition] dialog box (see figure 6.41, [Trace Acquisition] dialog box).
- (2) Register the address range for trace acquisition as an event condition. Click the [Add...] button in the [Trace Events] group box on the [General] page to display the [Breakpoint/Event Properties] dialog box (see figure 6.42, [Breakpoint/Event Properties] dialog box).
- (3) Click the [Range] radio button in the [Address] group box on the [General] page of the [Breakpoint/Event Properties] dialog box. Use the [Locals] window to refer to the address on the line where variable `a`, which is defined within the `tutorial` function, is allocated (`H'00FFFEF8` in this example) and enter this address in the [Address Lo] edit box. Then enter an address, which is `H'27` added to that entered in the [Address Lo] edit box (`H'00FFFEFA7` in this example), in the [Address Hi] edit box. This procedure sets the memory range for variable `a` of the `tutorial` function.
- (4) Click the [Write] radio button in the [Direction] group box to set a write cycle for the specified range. This completes the setting of a memory range. Click the [OK] button to close the [Breakpoint/Event Properties] dialog box.

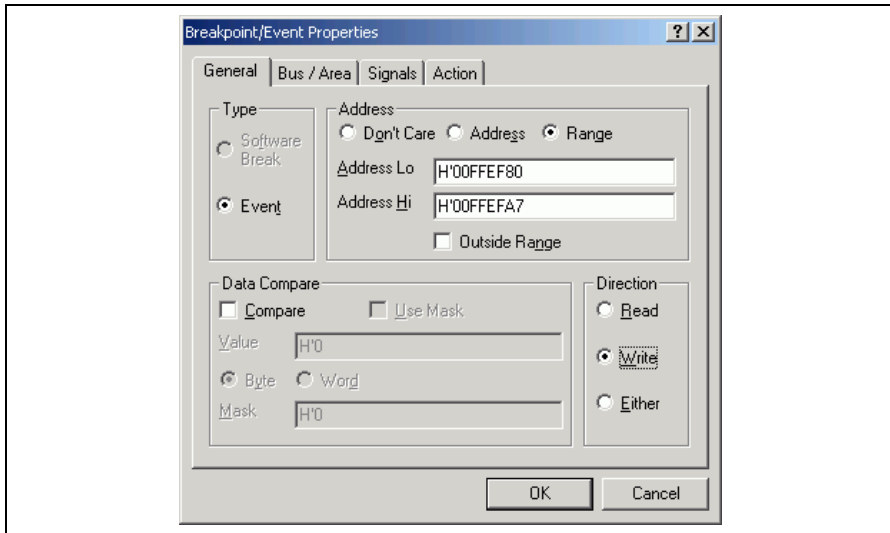

Figure 6.49 [Breakpoint/Event Properties] Dialog Box (after Setting an Event)

- (5) The event that has been set in the [Event] combo box of the [Trace Events] group box on the [General] page of the [Trace Acquisition] dialog box is displayed.

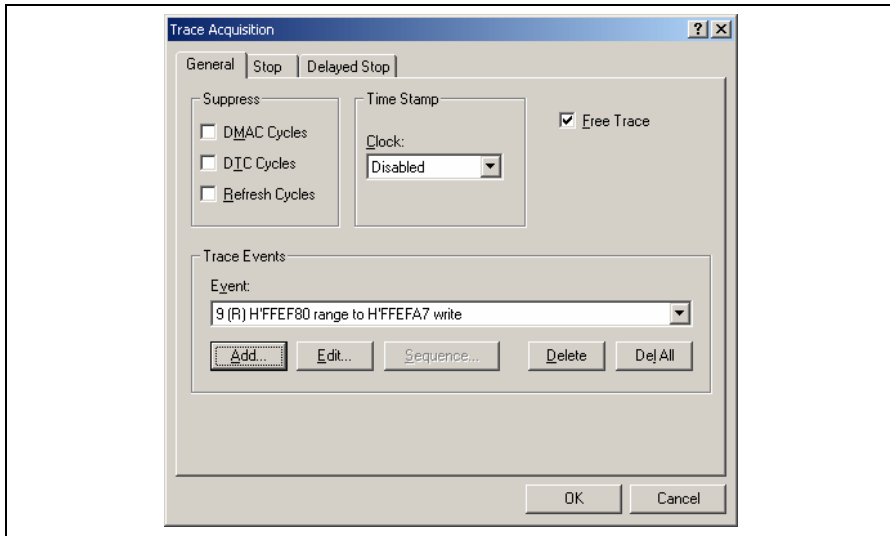

Figure 6.50 [Trace Acquisition] Dialog Box (Adding an Event)

- (6) To enable time stamping, select 125ns from the [Clock] combo box of the [Time Stamp] group box.

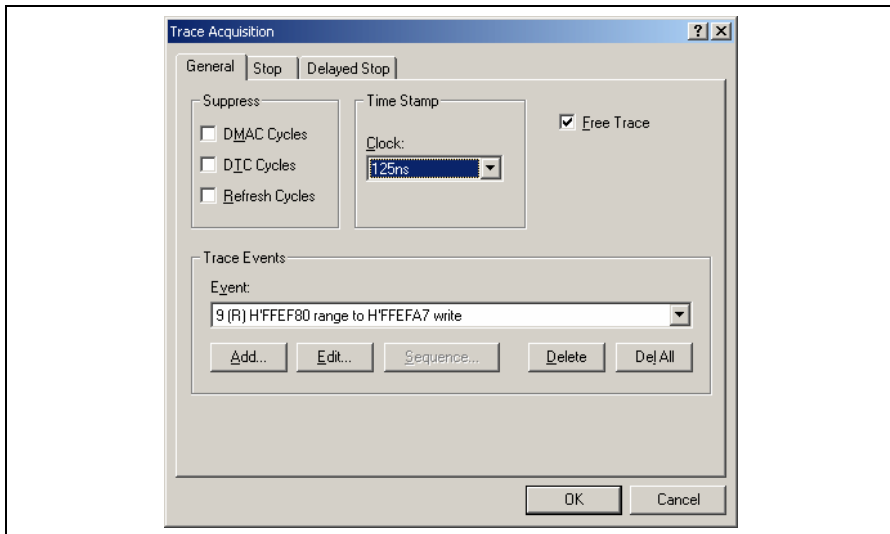

Figure 6.51 [Trace Acquisition] Dialog Box (Time Stamping is Available)

- (7) To enable the event condition that has been set, uncheck the [Free Trace] check box on the [General] page. This will add pages [1] to [4] (see figure 6.45, [Trace Acquisition] dialog box).
- (8) Select page [1] and click the [Range] radio button in the [Conditions] group box. This will display the [Range Event] combo box and the [Edit...] button (see figure 6.46, [Trace Acquisition] dialog box).
- (9) Click the [Range Event] combo box to select the event you have registered. The event is now enabled. Click the [OK] button to complete the trace setting.

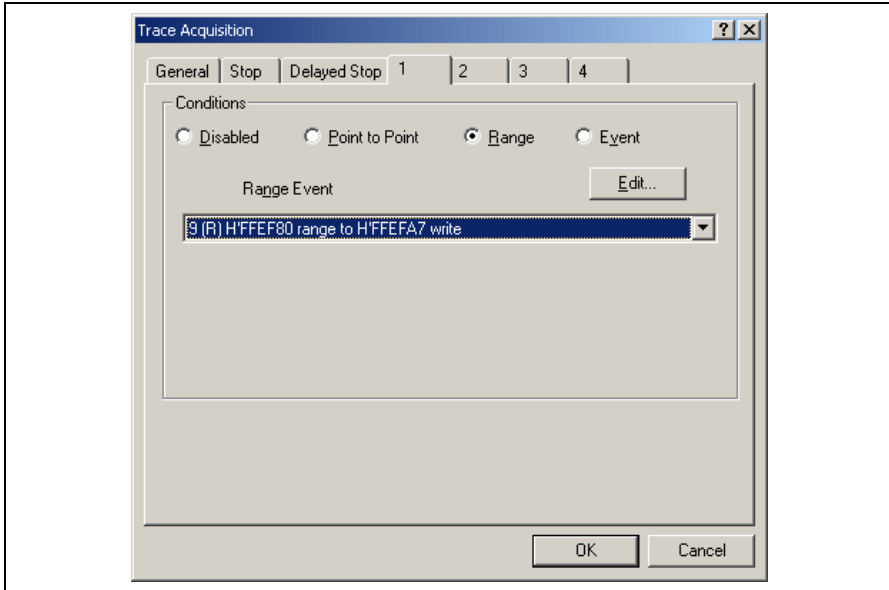

Figure 6.52 [Trace Acquisition] Dialog Box (Setting Completed)

- (10) Make the setting such that the break occurs after the instruction at the address on the line that has 'p_sam->s0=a[0];' within the tutorial function (H'00001082 in this example) (for details on this, refer to section 6.15.1, Software Break Function).

- (11) Select [Reset Go] from the [Debug] menu. Processing stops when the break condition is satisfied, and the [Trace] window then displays the following content.

PTR	Address	I.	Data	R/W	A	S	C	P	K	I	Timestamp	Timestamp-Difference	Source
-00012	ffef8e		41c6	WR							0000h000min000s001ms081us875ns	0000h000min000s000ms000us000ns	
-00011	ffef90		0000	WR							0000h000min000s001ms084us125ns	0000h000min000s000ms002us250ns	
-00010	ffef92		3f54	WR							0000h000min000s001ms084us250ns	0000h000min000s000ms000us125ns	
-00009	ffef94		0000	WR							0000h000min000s001ms086us375ns	0000h000min000s000ms002us125ns	
-00008	ffef96		2781	WR							0000h000min000s001ms086us500ns	0000h000min000s000ms000us125ns	
-00007	ffef98		0000	WR							0000h000min000s001ms088us750ns	0000h000min000s000ms002us250ns	
-00006	ffef9a		1cfb	WR							0000h000min000s001ms088us875ns	0000h000min000s000ms000us125ns	
-00005	ffef9c		0000	WR							0000h000min000s001ms091us000ns	0000h000min000s000ms002us125ns	
-00004	ffef9e		167e	WR							0000h000min000s001ms091us125ns	0000h000min000s000ms000us125ns	
-00003	ffefa0		0000	WR							0000h000min000s001ms093us375ns	0000h000min000s000ms002us250ns	
-00002	ffefa2		15fb	WR							0000h000min000s001ms093us375ns	0000h000min000s000ms000us000ns	
-00001	ffefa4		0000	WR							0000h000min000s001ms095us625ns	0000h000min000s000ms002us250ns	
+00000	ffefa6		0ff6	WR							0000h000min000s001ms095us750ns	0000h000min000s000ms000us125ns	

Figure 6.53 [Trace] Window (Displaying the Result)

If you have trouble viewing a column, drag the header (vertical) bars below the title bar to adjust the width of the column.

- (12) Remove the event points that have been set and clear the trace information. Clicking the right-hand mouse button on the [Breakpoints] window displays a popup menu. Select [Delete All] from this menu to remove all the event points that have been set. Clicking the right-hand mouse button on the [Trace] window displays a further popup menu. Select [Clear] from this menu to clear the trace information. To disable time stamping, select Disabled in the [Clock] combo box of the [Time Stamp] group box on the [General] page of the [Trace Acquisition] dialog box.

6.16.3 Statistics

The number of times the internal RAM has been written to can be included in the acquired trace information.

- (1) Make the setting such that a break occurs at the address on the line that has 'p_sam->s0=a[0];' within the tutorial function (**H'00001082** in this example) (for details on this, refer to section 6.15.1, Software Break Function).
- (2) Select [Reset Go] from the [Debug] menu. Processing stops when the break condition is satisfied, and the [Trace] window then displays trace information.
- (3) Select [Statistic...] from the popup menu that is displayed when you click the right-hand mouse button on the [Trace] window. A message box appears, indicating that the trace data is being loaded, and the [Statistic] dialog box will be displayed.

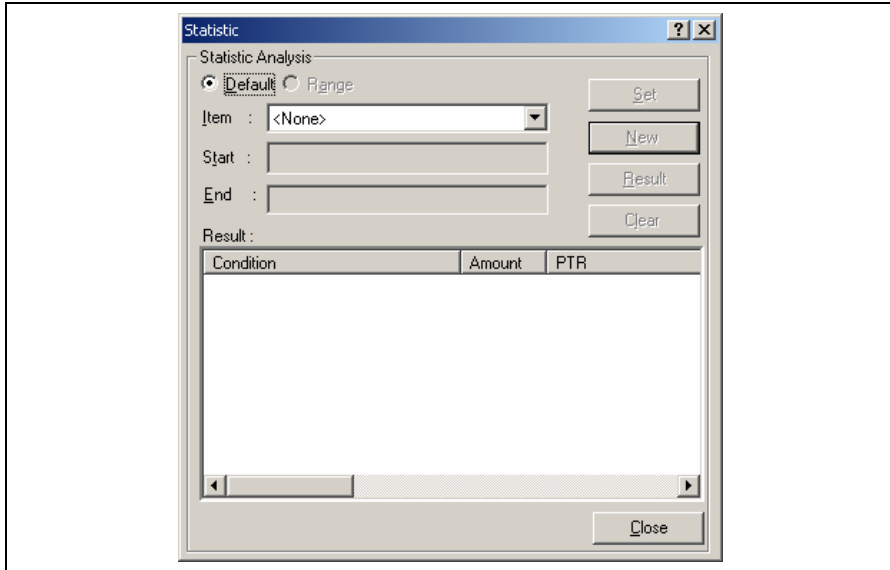

Figure 6.54 [Statistic] Dialog Box

- (4) Select R/W in the [Item] combo box and enter WR in the [Start] edit box. After that, click the [New] button. “R/W=WR” is now displayed in the [Condition] column of the [Result] list box.

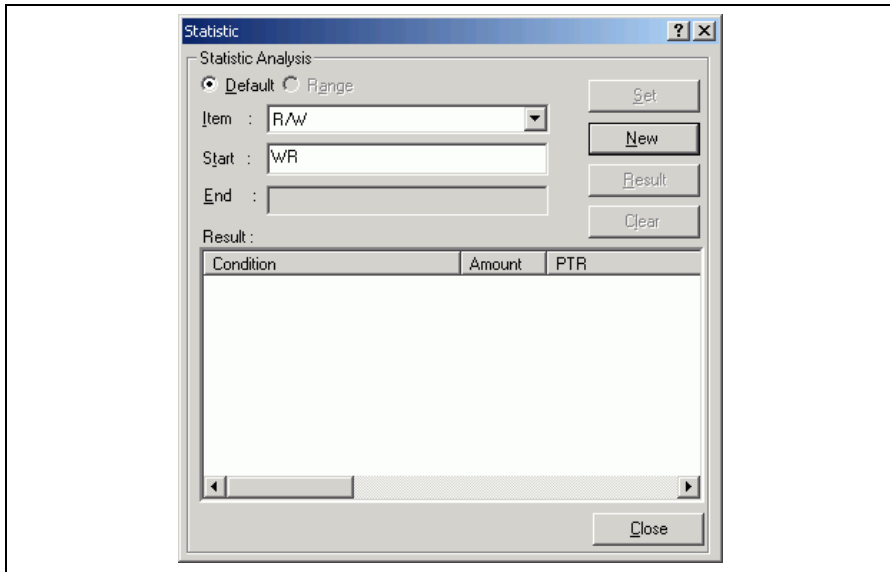

Figure 6.55 [Statistic] Dialog Box (New Condition)

- (5) Then, select Area from the [Item] combo box and enter RAM in the [Start] edit box. After that, click the [Add] button; the new condition is now added to the “R/W=WR” display in the [Condition] column of the [Result] list box, so that it now shows “R/W=WR & Area=RAM”. This completes setting of the condition.

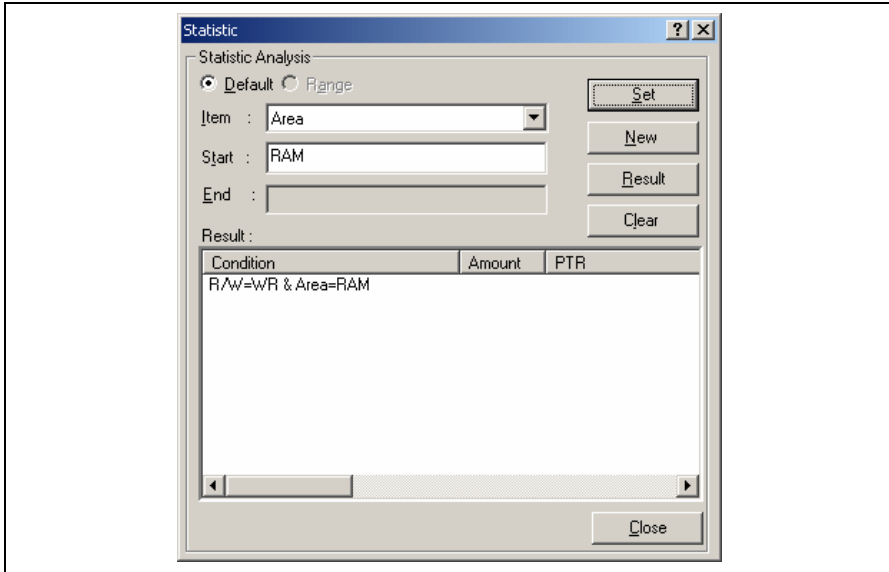

Figure 6.56 [Statistic] Dialog Box (Condition Added)

- (6) To start statistical analysis of the specified condition, press the [Result] button. The number of write operations that satisfy the condition and the PTR values will be displayed.

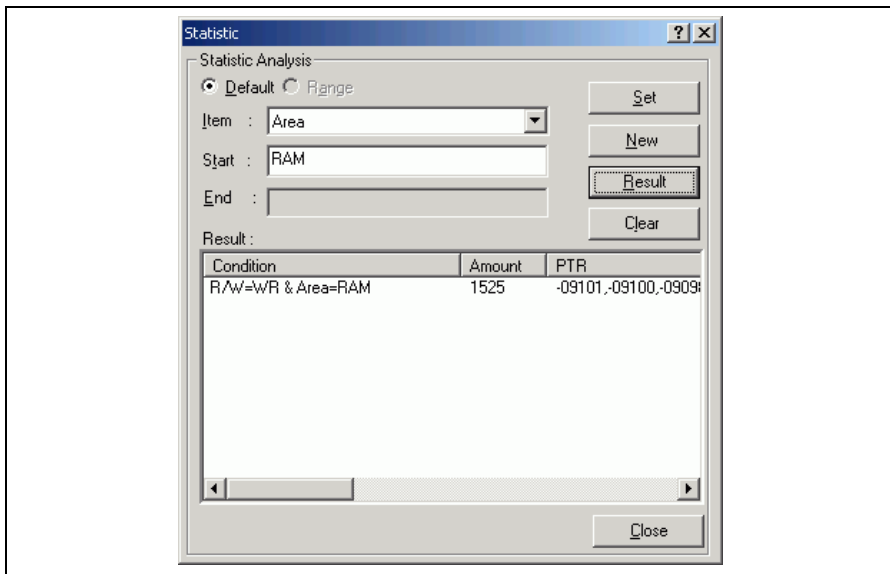

Figure 6.57 [Statistic] Dialog Box (Result of Analysis)

- (7) Click the [Close] button to close the [Statistic] dialog box.
- (8) Remove the event points that have been set and clear the trace information. Clicking the right-hand mouse button on the [Event] window displays a popup menu. Select [Delete All] from this menu to remove all the event points that have been set. Clicking the right-hand mouse button on the [Trace] window displays a further popup menu. Select [Clear] from this menu to clear the trace information.

6.16.4 Function Calls

This mechanism is used to only collect trace information on the function calls.

- (1) Make the setting such that a break occurs at the address on the line that has 'p_sam->s0=a[0];' within the tutorial function (**H'00001082** in this example) (for details on this, refer to section 6.15.1, Software Break Function).
- (2) Select [Reset Go] from the [Debug] menu. Processing stops when the break condition is satisfied, and the [Trace] window then displays trace information.
- (3) Select [Function Call...] from the popup menu displayed by clicking the right-hand mouse button on the [Trace] window. The [Function Call Display] dialog box will be displayed.

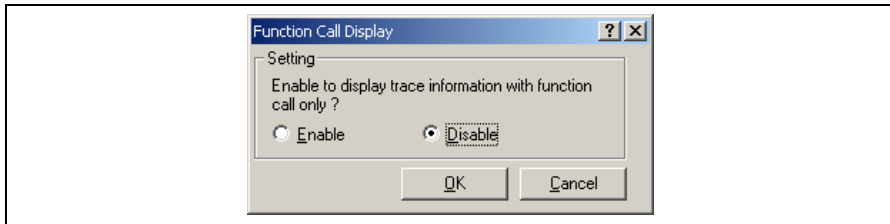

Figure 6.58 [Function Call Display] Dialog Box

- (4) Click the [Enable] radio button and then the [OK] button. Only the information on function calls is now displayed in the [Trace] window (the [Label] column's right-side boundary has been moved to the left in the [Trace] window to show the function calls).

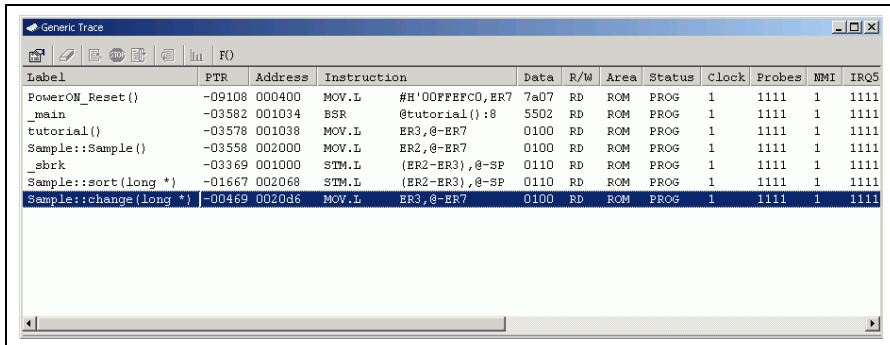

Figure 6.59 [Trace] Window (Function Calls)

- (5) To return the display in the [Trace] window to its previous state, follow the procedure in (3) to display the [Function Call Display] dialog box. Click the [Disable] button and then the [OK] button.
- (6) Remove the event points that have been set and clear the trace information. Clicking the right-hand mouse button on the [Breakpoints] window displays a popup menu. Select [Delete All] from this menu to remove all the event points that have been set. Clicking the right-hand mouse button on the [Trace] window displays a further popup menu. Select [Clear] from this menu to clear the trace information.

6.17 Stack Trace Function

The emulator uses the information on the stack to display the function call history.

Notes: 1. This function can be used only when the load module that has the Dwarf2-type debugging information is loaded. Such load module is supported in H8S, H8/300 C/C++ compiler V4.0 or later.

2. For details on the stack trace function, refer to the online help.

- Double-click the [Editor] column in the `sort` function and set a software breakpoint.

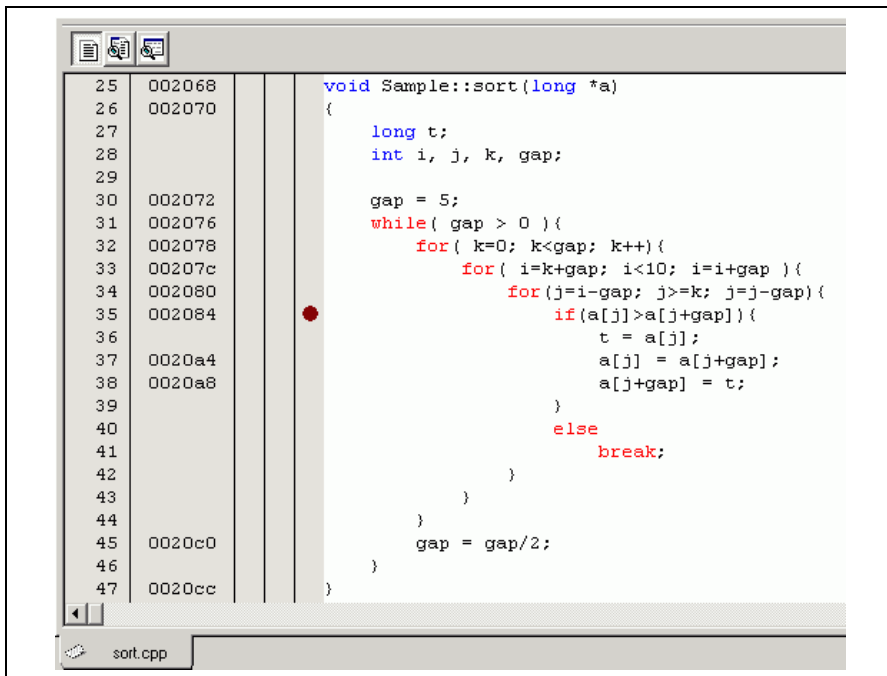

Figure 6.60 [Editor] Window (Software Breakpoint Setting)

- Select [Reset Go] from the [Debug] menu.
- After the break in program execution, select [Stack Trace] from the [Code] submenu of the [View] menu to open the [Stack Trace] window.

Kind	Name	Value
F	Sample::sort(long *)	{ 002084 }
F	tutorial()	{ 00107A }
F	main()	{ 001036 }
F	PowerON_Reset()	{ 00041E }

Figure 6.61 [Stack Trace] Window

Figure 6.61 shows that the position of the program counter is currently at the selected line of the `sort()` function, and that the `sort()` function is called from the `tutorial()` function.

To remove the software breakpoint, double-click the [Editor] column in the `sort` function again.

6.18 Performance Measurement Function

Performance measurement by the emulator is in the following modes:

- Time Of Specified Range Measurement
- Start Point To End Point Measurement
- Start Range To End Range Measurement
- Access Count Of Specified Range Measurement
- Called Count Of Specified Range Measurement

In this tutorial, we describe the Time Of Specified Range Measurement.

6.18.1 Time Of Specified Range Measurement

(1) Select [Performance Analysis] from the [Performance] submenu of the [View] menu to display the [Select Performance Analysis Type] dialog box.

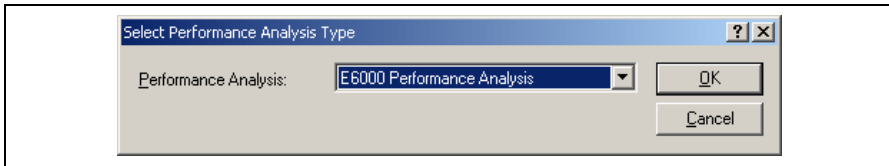

Figure 6.62 [Select Performance Analysis Type] Dialog Box

(2) Select "E6000 Performance Analysis" from the [Performance Analysis] combo box in the [Select Performance Analysis Type] dialog box and click the [OK] button. The [Performance Analysis] window will be displayed.

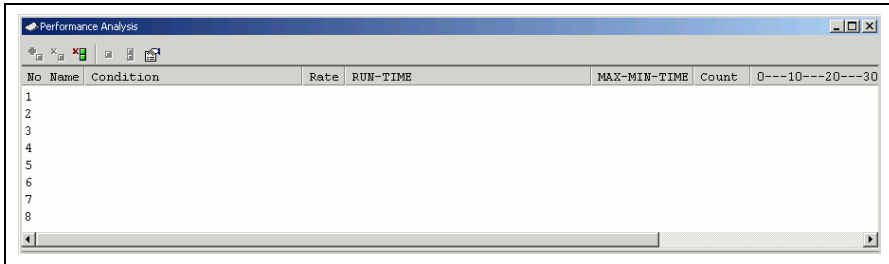

Figure 6.63 [Performance Analysis] Window

- (3) Select the line of the [Performance Analysis] window that has 1 in its [No] column and click the right-hand mouse button to display a popup menu. Select [Set...] from this popup menu to display the [Performance Analysis Properties] dialog box.

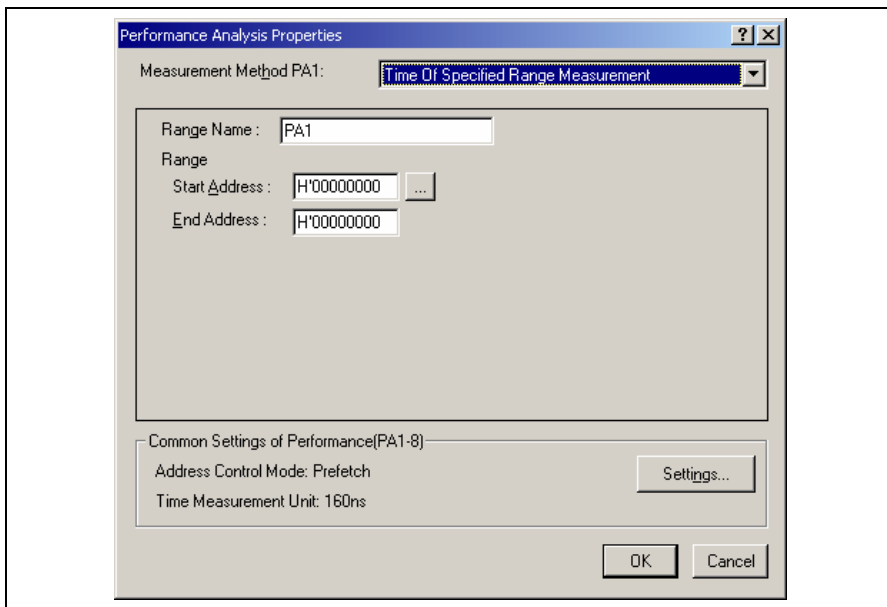

Figure 6.64 [Performance Analysis Properties] Dialog Box

- (4) Select Time Of Specified Range Measurement from the [Measurement Method PA1] combo box.
(5) The parameter settings are as follows.

- Enter "sort" in the [Range Name] edit box.
- Click the [...] button to the right of the [Start Address] edit box to display the [Input Function Range] dialog box. Enter the function name "Sample::sort(long *)" in the [Function] edit box of this dialog box and then click the [OK] button. The corresponding addresses for the function "Sample::sort(long *)" will now be set in the [Start Address] and [End Address] edit boxes.

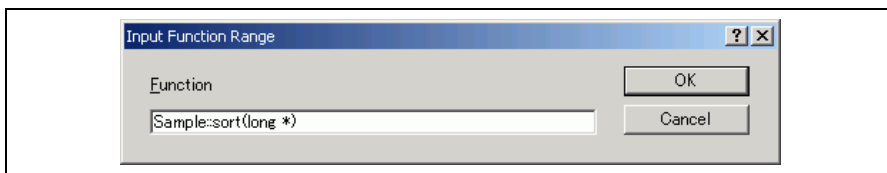

Figure 6.65 [Input Function Range] Dialog Box

Note: The addresses figured out in the [Input Function Range] dialog box are just for reference. In some cases, the end address of a function may be different. Check the last instruction of the function in the [Disassembly] window to correct the value set in [End Address] so that it will be the address of the last instruction (in general, the last instruction of a function is a RTS instruction). A label name or an expression can be entered instead of an address value in boxes where an address should be entered.

- (6) Click the [Settings...] button in the [Common Settings of Performance(PA1-8)] group box to display the [Common Settings of Performance(PA1-8)] dialog box. Select [PC] from the [Address Control Mode] combo box and then click the [OK] button. PC is now displayed in the [Address Control Mode] text field of the [Common Setting of Performance(PA1-8)] dialog box.

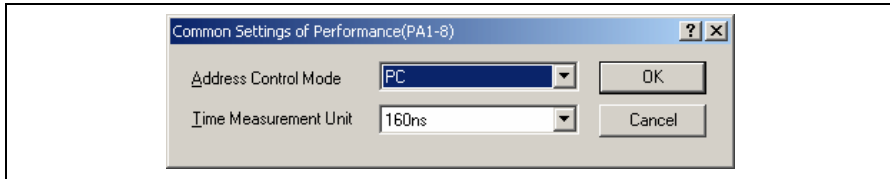

Figure 6.66 [Common Setting of Performance(PA1-8)] Dialog Box

- (7) Click the [OK] button to display the content that has been set for line 1 of the [No] column in the [Performance Analysis] window. This completes the settings for a Time Of Specified Range Measurement.

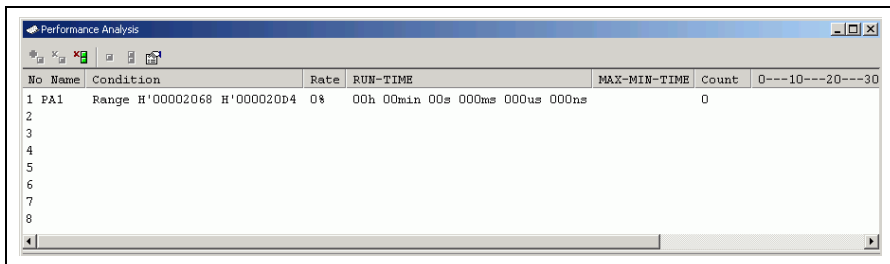

Figure 6.67 [Performance Analysis] Dialog Box (Setting Completed)

- (8) Set an event point at the address on the line that has 'p_sam->change(a);' within the tutorial function (H'0000107 in this example) so that a break occurs when the specified sort function has been executed three times (refer to section 6.15.2, Breaking Execution at Event Points).
- (9) Select [Reset Go] from the [Debug] menu. Processing stops when the break condition is satisfied, and the [Performance Analysis] window then displays the information shown below. The value shown in the [Count] column is 3, which indicates that the sort function has been executed three times and the execution time.

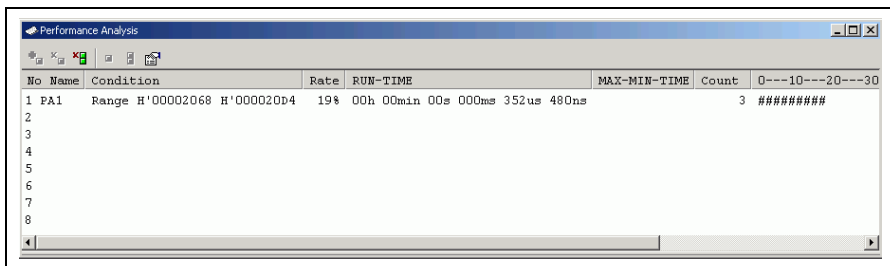

Figure 6.68 [Performance Analysis] Dialog Box (Displaying the Result)

- (10) Delete the setting for performance analysis and remove the event point. Click the right-hand mouse button on the [Performance Analysis] window to display a popup menu. Select [Reset All] from this popup menu to delete all of the settings. Clicking the right-hand mouse button on the [Event] window also displays a popup menu. Select [Delete All] from this popup menu to remove all the event points that have been set.

6.19 Monitor Function

The emulator allows monitoring of the content of specified addresses in memory during execution of the user program. In this example, we monitor the content of the address range where variable `a` of the `tutorial` function is stored.

- (1) Select the [CPU] submenu from the [View] menu. Then selecting [Monitor Setting...] from the [Monitor] submenu displays the [Monitor Setting] dialog box.

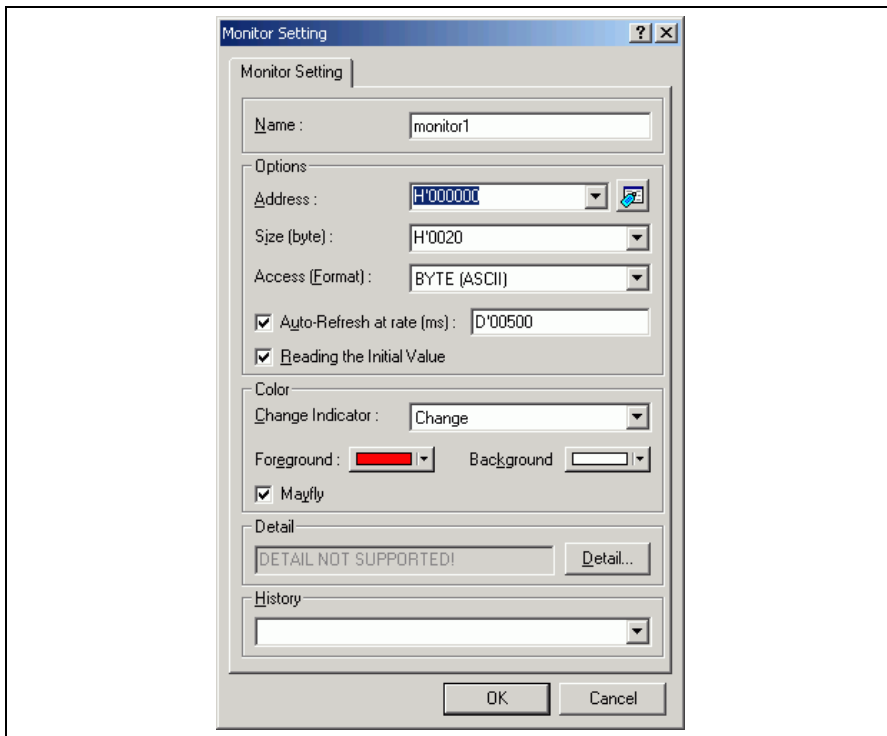

Figure 6.69 [Monitor Setting] Dialog Box

(2) Set the items in the [Monitor Setting] dialog box as follows:

- Enter monitor1 in the [Name] edit box.
- Set the parameters in the [Options] group box as follows:
 - (a) Use the [Locals] window to refer to the address on the line where variable a, which is defined within the tutorial function, is allocated and enter this address in the [Address] edit box. In this example, enter **H'00FFEF80**.
 - (b) Enter **H'50** in the [Size] edit box.
 - (c) Select **BYTE (HEX)** from the [Access] combo box.
 - (d) Check the [Auto-refresh at rate] check box and enter **D'00500**.
 - (e) Check the [Reading the Initial Value] check box.
- Set the parameters in the [Color] group box as follows:
 - (a) Select **Change** from the [Change Indicator] combo box.
 - (b) Select **red** and **white** in the [Foreground] and [Background] combo boxes, respectively.
 - (c) Check the [Mayfly] check box.

Note: Depending on the operating system in use, the foreground and background colors may not be selectable.

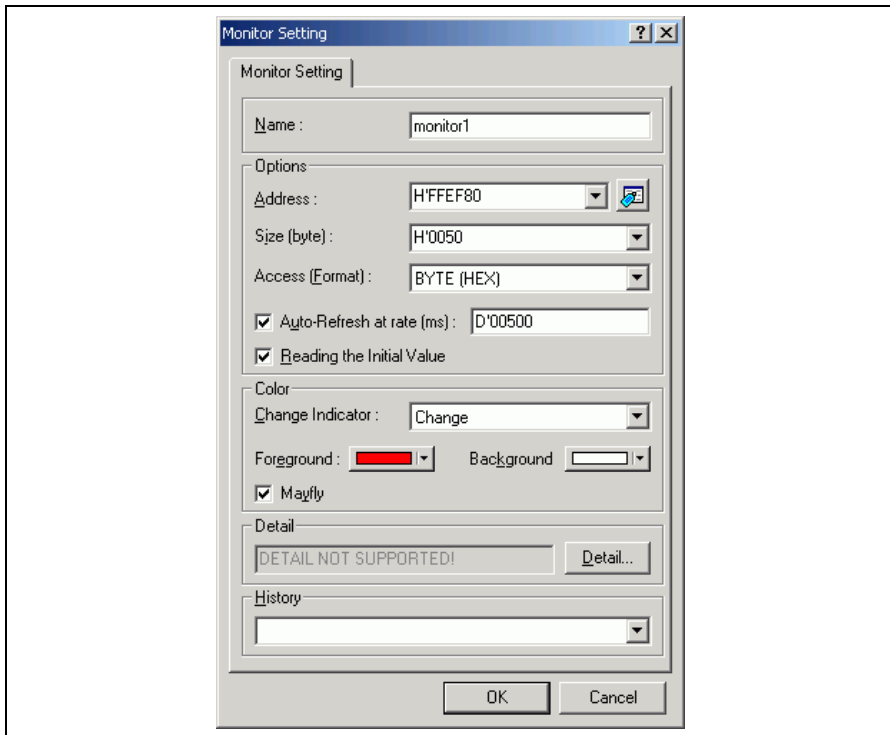

Figure 6.70 [Monitor Setting] Dialog Box (Setting Completed)

(3) Click the [OK] button to open the [Monitor] window.

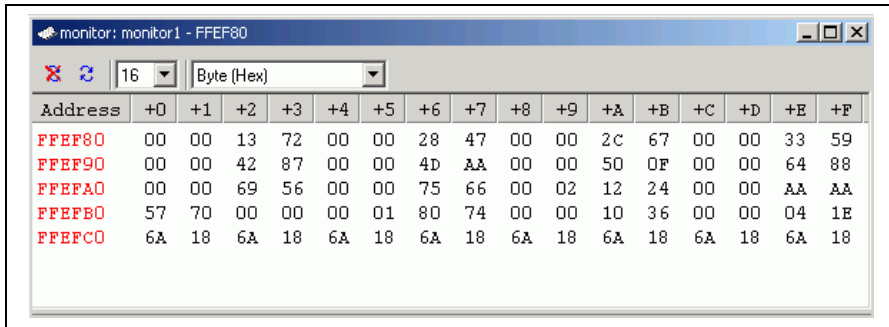

Figure 6.71 [Monitor] Window

(4) Select [Reset Go] from the [Debug] menu. When the content of the address range changes with execution, the updated values are red (i.e. the color that was selected in the [Foreground] and [Background] combo boxes). Values will be displayed in black if they have not been updated or a certain period of time has elapsed since the last update.

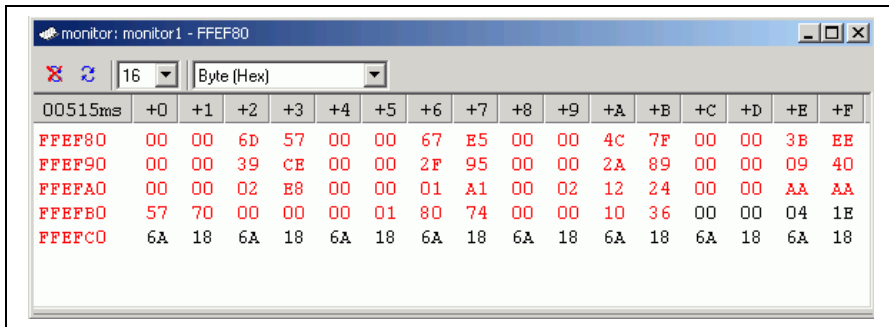

Figure 6.72 [Monitor] Window (during Execution)

(5) After you have finished checking the states in the [Monitor] window, select [Halt Program] from the [Debug] menu to halt the program's execution.

6.20 What Next?

This tutorial has described the major features of the emulator and the use of the High-performance Embedded Workshop.

Sophisticated debugging can be carried out by using the emulation functions that the emulator offers. This provides for effective investigation of hardware and software problems by accurately isolating and identifying the conditions under which such problems arise.

Section 7 Hardware Specifications Specific to This Product

This section describes the hardware specifications on the H8/3664 E6000 emulator.

7.1 H8/3664 E6000 Emulator Specifications

The H8/3664 E6000 emulator supports the system development using the following microcomputers:

- H8/3664 group
- H8/3664N
- H8/3672 group
- H8/3687 group
- H8/3687N
- H8/3694 group
- H8/3694N
- H8/36014 group
- H8/36057 group
- H8/36037 group
- H8/36024 group
- H8/36049 group
- H8/36902 group
- H8/36912 group
- H8/36077 group
- H8/36087 group
- H8/36109 group
- H8/36064 group
- H8/36094 group
- H8/36079 group

7.1.1 Supported Items

For emulation of the H8/36057 group or the H8/36037 group, an expansion I/O board (HS36037EIO61H) is required.

For emulation of the H8/36024 group or the H8/36049 group, an expansion I/O board (HS36024EIO61H) is required.

For emulation of the H8/36109 group, an expansion I/O board (HS36109EIO61H) is required.

For notes on the user cable and the expansion I/O board, refer to the user's manual provided for each of them.

See the development support tool catalog for the MCU type names and packages supported by the E6000 emulator and for the combination of the E6000 user system interface cables and optional boards.

7.1.2 Operating Voltage and Frequency Specifications

Table 7.1 shows the MCU operating voltage and frequency specifications supported by the E6000 emulator. If the emulator is used in an environment that exceeds the operating voltage range and operating frequency range guaranteed for the MCU operation, normal emulator operation is not guaranteed. Note that the operation with low voltage or high frequency is not supported in some MCUs.

Table 7.1 Operating Voltage and Frequency Specifications

No.	MCU Types	Operating Voltage (V)	Operating Frequency (f) (MHz)
1	H8/3664 group (except for H8/3664F)	2.7-5.5	1-10
		4.0-5.5	1-16
2	H8/3664F	3.0-5.5	1-10
	H8/3664N	4.0-5.5	1-16
3	H8/3672 group	3.0-5.5	1-10
		4.0-5.5	1-16
4	H8/3687 group	2.7-5.5	1-10
	H8/3694 group	4.0-5.5	1-20
5	H8/3684F	3.0-5.5	1-10
	H8/3687F		
	H8/3687N		
	H8/3694F	4.0-5.5	1-20
	H8/3694N		
6	H8/36014 group	3.0-5.5	1-10
		4.0-5.5	1-20
7	H8/36024 group	3.0-5.5	1-10
	H8/36049 group	4.0-5.5	1-20
8	H8/36037 group	3.0-5.5	1-10
	H8/36057 group	4.0-5.5	1-20
9	H8/36902 group	2.7-5.5	2-10
	H8/36912 group		
10	H8/36077 group	4.5-5.5	4-20
11	H8/36087 group	3.0-3.6	4-18
12	H8/36109 group	3.0-5.5	4-10
		4.0-5.5	4-20
13	H8/36064 group	3.0-5.5	1-10
		4.0-5.5	1-20
14	H8/36094 group	2.7-5.5	4-10
		4.0-5.5	4-20
15	H8/36079 group	4.5-5.5	4-20
		3.0-3.6	4-16

NOTE

For details on the operating voltage and frequency specifications, refer to the MCU hardware manual.

7.2 User System Interface

All user system interface signals are directly connected to the MCU in the emulator with no buffering except for those listed below which are connected to the MCU through control circuits:

- NMI
- /RES
- OSC1
- X1
- TEST
- V_{cl}

7.2.1 Signal Protection

All user system interface signals are protected from over- or under-voltage by use of diode arrays except for the AVcc.

Pull-up resistors are connected to the port signals except for the analog port signals.

The Vcc pins (except for the AVcc pin) at the head of the user system interface cable are connected together. The emulator monitors the voltage level of the Vcc pins and displays the power-supply status in the [Extended Monitor] window.

If the user system interface cable is not connected to the user system, the UVcc of the MCU is 5 V.

7.2.2 User System Interface Circuits

The interface circuit between the MCU in the emulator and the user system has a signal delay of about 8 ns due to the user system interface cable and it includes pull-up resistors. Therefore, high-impedance signals will be pulled up to the high level. When connecting the E6000 emulator to a user system, adjust the user system hardware to compensate for propagation delays.

Default:

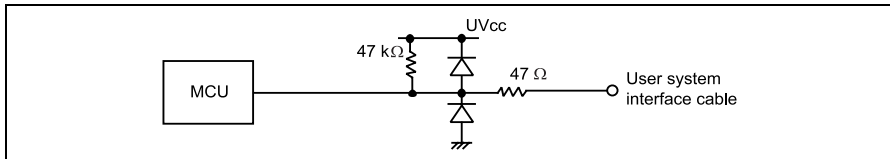

Figure 7.1 Default User System Interface Circuit

/RES and NMI: The NMI signal is input to the MCU through the emulator control circuit. The rising/falling time of the signal must be 8 ns/V or less.

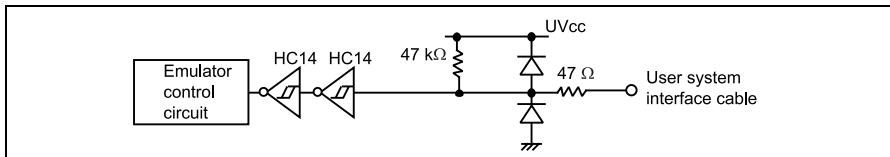

Figure 7.2 User System Interface Circuit for /RES and NMI

PB0 to PB7 (pins used for AN0 to AN7), AVcc and AVss:

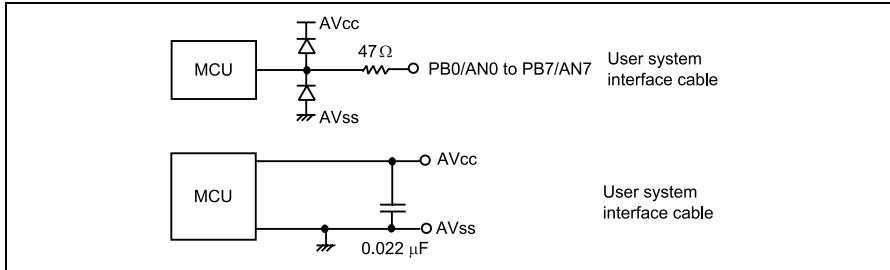

Figure 7.3 User System Interface Circuit for PB0 to PB7, AVcc and AVss Signals

V_{CL} and TEST: When V_{CL} is connected to GND or the TEST pin is connected to the Vcc level, a warning message to indicate that the pin connections are incorrect will be displayed when the emulator is connected. Recheck these pins on the user system.

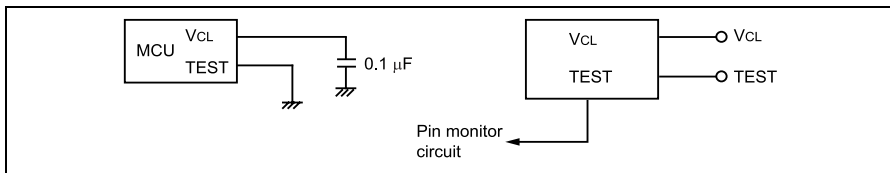

Figure 7.4 V_{CL} and TEST System Interface Circuit

7.3 Differences between MCU and Emulator

When the emulator is turned on or initialized, or the system is reset, there are some differences in the initial values in some of the general registers between the MCU and the emulator as shown in table 7.2.

Table 7.2 Initial Value Differences between MCU and Emulator

Status	Register	E6000 Emulator	MCU
Power-on/ initialized	PC	Reset vector value	Reset vector value
	ER0 to ER6	Undefined	Undefined
	ER7 (SP)	H'10	Undefined
	CCR	The I mask is set to 1 and the other bits are undefined	The I mask is set to 1 and the other bits are undefined
Reset command	PC	Reset vector value	Reset vector value
	ER0 to ER6	Undefined	Undefined
	ER7 (SP)	H'10	Undefined
	CCR	The I mask is set to 1 and the other bits are undefined	The I mask is set to 1 and the other bits are undefined

7.3.1 A/D Converter and D/A Converter

Due to the use of a user system interface cable, there is a slight degradation in the A/D and D/A conversion than that quoted in the Hardware Manual for the MCU being emulated.

7.4 Handling Serial EEPROM Board

WARNING

Always switch OFF the emulator and user system before connecting or disconnecting the serial EEPROM board and make sure that the pin 1 on both sides are correctly aligned. Failure to do so will result in a FIRE HAZARD and will damage the user system and the emulator product or will result in PERSONAL INJURY. The USER PROGRAM will be LOST.

To remove and fasten the emulator cover, take the following steps.

1. Remove four screws from the sides of the emulator station.
2. Pull the emulator cover upward and remove it.
3. Install the serial EEPROM board in the serial EEPROM socket (M1) of the emulator.
4. Close the emulator cover and fasten it with the four screws.

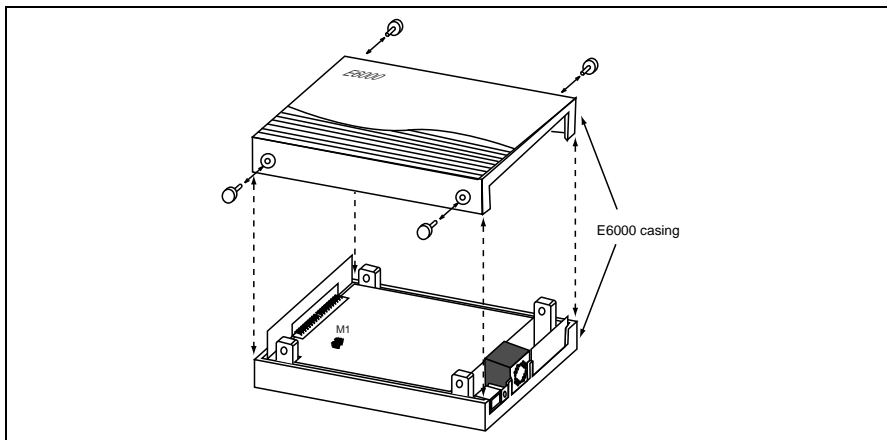

Figure 7.5 Removing and Fastening the Emulator Cover

This emulator includes a serial EEPROM board (HS3664PWB65H) for evaluation of the H8/3664N (on-chip EEPROM). Figure 7.6 shows the installation of this serial EEPROM board. Align pin 1 with pin 1 of serial EEPROM socket (M1) on the emulator. The serial EEPROM board must be installed to evaluate the H8/3664N. When evaluating any other MCU, remove the serial EEPROM board. The slave address code of the serial EEPROM board is always H'00. Note that the slave address code can be rewritten to H'00 to H'07; however, the slave address of this serial EEPROM board must always be H'00 (initial value of H8/3664N on-chip EEPROM). The EEPROM can be programmed up to 100,000 times. If programming exceeds 100,000 times, purchase a new serial EEPROM board (HS3664PWB65H) and change it with the old one.

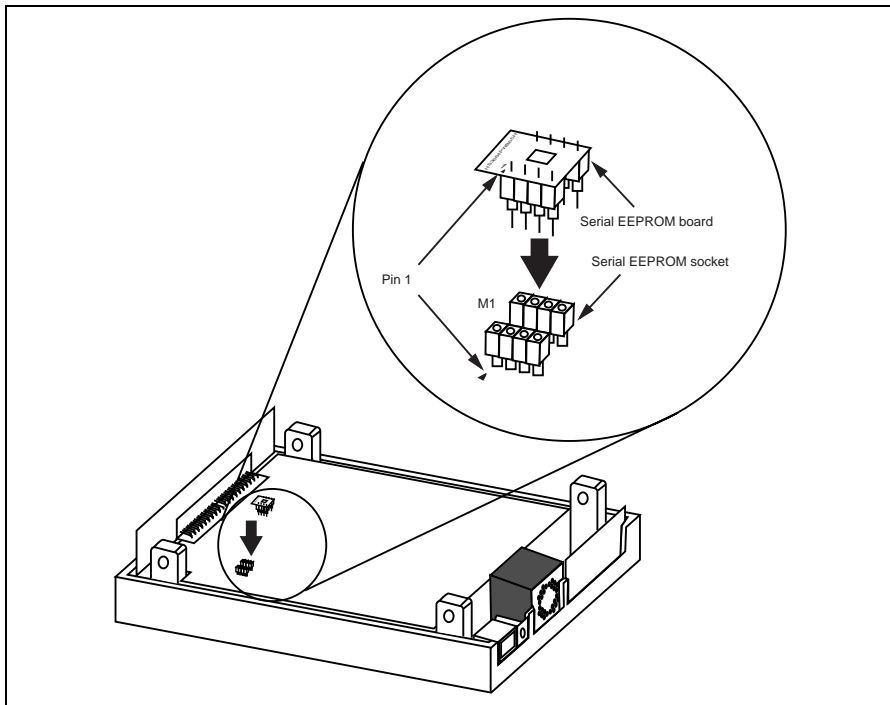

Figure 7.6 Installing Serial EEPROM Board

7.5 Host PC Interface

This emulator (HS3664EPI62H) incorporates a USB interface circuit as the host PC interface. The specifications of this emulator comply with USB 1.1 (full speed) and can also be connected to a USB 2.0 host computer. Connecting the attached USB interface cable to the host computer enables a direct connection between the host computer and the emulator. Thus connection of the USB interface adapter for the E6000 (such as HS6000EIU02H) is no longer necessary. To use a host PC interface other than USB (PCI, PCMCIA, or LAN), prepare a corresponding host PC interface board for the E6000 separately sold and connect it to the emulator. Note, however, that the USB interface will not be available if a PC interface cable is connected to the emulator. To enable the USB interface function, disconnect the PC interface cable from the emulator. The USB interface is also not available with the Windows NT[®] environment.

Section 8 Software Specifications Specific to This Product

This section describes the software specifications of the H8/3664 E6000 emulator.

8.1 Software Specifications of the H8/3664 E6000 Emulator

Information specific to this emulator is given below.

8.1.1 Target Hardware

This emulator software conforms to the H8/3664 E6000 (HS3664EPI61H, HS3664EPI62H) emulator.

8.1.2 Selectable Platforms

The debugging platforms selectable in this emulator are listed below.

Table 8.1 Selectable Target Platforms

Debugging Platform	Remark
H8/3664 E6000 Emulator CPU 300H	For emulation of the MCUs that have the H8/300H CPU as the core without any expansion I/O board in use.
H8/36037 E6000 Emulator CPU 300H	For emulation of the MCUs that have the H8/300H CPU as the core with the expansion I/O board (HS36037EIO61H) in use.
H8/36024 E6000 Emulator CPU 300H	For emulation of the MCUs that have the H8/300H CPU as the core with the expansion I/O board (HS36024EIO61H) in use.
H8/36109 E6000 Emulator CPU 300H	For emulation of the MCUs that have the H8/300H CPU as the core with the expansion I/O board (HS36109EIO61H) in use.

8.1.3 [Configuration Properties] Dialog Box ([General] Page)

Items that can be set in this dialog box are listed below.

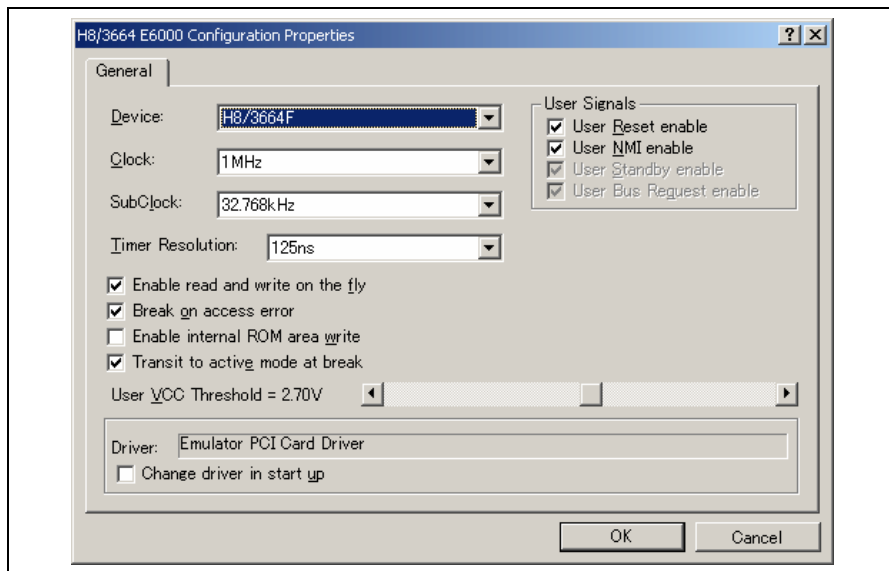

Figure 8.1 [Configuration Properties] Dialog Box ([General] Page)

[General] page

[Device]	Selects the MCU to be emulated. To use an MCU not included in the list, select [Custom] to specify the functions required for this MCU. See the hardware manual for details.
[Clock]	Selects the speed of the MCU's clock.
[SubClock]	Selects the speed of the MCU's sub-clock. (Note that selection is not available when emulating the H8/3672 group, H8/36014 group, H8/36024 group, H8/36902 group, H8/36912 group, or H8/36064 group.)
[Timer Resolution]	<p>Selects the resolution of the timer for use in execution time measurement. The value 20 ns, 125 ns, 250 ns, 500 ns, 1 us, 2 us, 4 us, 8 us, or 16 us can be selected.</p> <p>The timer for execution time measurement has a 40-bit counter.</p> <p>At 20 ns the maximum time that can be measured is about six hours, and at 16 μs the maximum time is about 200 days.</p> <p>When the counter overflows, the maximum time possible for measurement will be displayed with prompt ">" that indicates that the counter has overflowed.</p>
[Enable read and write on the fly]	<p>When this box is checked, it is possible to access the target system memory while the user program is running. Do not check this box if you require realtime emulation.</p> <ul style="list-style-type: none">- When accessing the internal ROM or internal RAM <p>High-performance Embedded Workshop accesses the memory directly as the bus mastership is released to the emulator without breaking the user program. The MCU waits for eight clock cycles in each access.</p> <ul style="list-style-type: none">- When accessing the internal I/O <p>Memory is accessed with breaking the user program. This pause is approximately 378 μs while operating at 16 MHz.</p> <p>When the internal RAM is disabled, an access to this area is not available during the user program execution.</p> <p>Note:</p> <p>When the content of the memory is modified during the user program execution (e.g. modification in the [Memory] window or by the MEMORY_EDIT command), High-performance Embedded Workshop reads the content to update the value.</p> <p>High-performance Embedded Workshop also reads the memory content when the content has been updated by operations such as selecting [Refresh] from the popup menu of the [Memory] window. In this case, the content of memory is read and then updated in each of the windows.</p> <p>To prevent unnecessary reading of the memory content, close the window displaying the memory content (such as the [Memory] or [Disassembly] window) or make the settings so that the content will not be updated.</p> <p>The [Monitor] window, or the [Watch] window that satisfies the conditions listed below displays the memory content. Note that, however, opening these windows does not prevent realtime operation because the method of updating the memory content in these windows is different.</p> <p>Conditions:</p> <ol style="list-style-type: none">1. Registered symbols are only allocated to general-purpose registers.2. Registered symbols are only allocated to the monitor range set by the [Monitor] function (the mark R is colored in blue).3. Registered symbols are comprised of those with the conditions 1 and 2 listed above.

[General] page (cont)

[Break on access error]	When this box is checked, a break (the user program stops) occurs if your program accesses an access-prohibited area or writes to a write-protected area.
[Enable internal ROM area write]	When this box is checked, writing to the internal ROM area is enabled. For the result of writing, see the [Extended Monitor] window.
[Transit to active mode at break]	Checking this box causes the emulator to enter the active mode when a break occurs if the emulator has been in the subactive mode immediately before the occurrence of a break. This allows a break processing by the system clock.
[User VCC Threshold]	Sets the voltage level for the user system. [Down] will be displayed in [User System Voltage] of the [Extended Monitor] window when the actual user VCC of the target system is lower than the specified value.
[User Signals]	When this box is checked, the reset and NMI signals from the user system are enabled.
[Driver]	Displays the E6000 driver that is currently installed.
[Change driver in start up]	When this box is checked, selection of a driver will be available next time the emulator is connected.

The MCUs selectable by the [Device] option and options that depend on the MCUs are listed below. To emulate an MCU with a description in the Expansion Hardware column, connect the correct expansion hardware.

Table 8.2 Environment for the H8/3664 E6000 Emulator CPU 300H Debugging Platform

[Device] Option	[Clock] Option	[SubClock] Option	Expansion Hardware
Custom	The MCU previously selected		
H8/3664	1 MHz	32.768 kHz	None
H8/3663	10 MHz	Target	
H8/3662	16 MHz		
H8/3661	Target		
H8/3660			
H8/3664F			
H8/3664N			
H8/3687			
H8/3686			
H8/3685			
H8/3684			
H8/3683			
H8/3682			
H8/3687F			
H8/3684F			
H8/3687N			
H8/3694			
H8/3693			
H8/3692			
H8/3691			
H8/3690			
H8/3694F			
H8/3694N			
H8/36094			
H8/36093			
H8/36092			
H8/36091			
H8/36090			
H8/36094F			
H8/36014F		Not available	
H8/36012F			
H8/3672F			
H8/3670F			
H8/36912			
H8/36911			
H8/36912F			
H8/36902			
H8/36901			
H8/36900			
H8/36902F			
H8/36064			
H8/36077		32.768 kHz	Target
H8/36087F		Target	
H8/36087			
H8/36086			
H8/36085			
H8/36084			
H8/36083			
H8/36082			
H8/36079			
H8/36078			

Note: Target in [Clock] and [SubClock] is only available when the target system is connected.

Table 8.3 Environment for the H8/36037 E6000 Emulator CPU 300H Debugging Platform

[Device] Option	[Clock] Option	[SubClock] Option	Expansion Hardware
Custom	The MCU previously selected		
H8/36037	1 MHz	32.768 kHz	HS36037EIO61H
H8/36036	10 MHz	Target	
H8/36035	16 MHz		
H8/36034	Target		
H8/36033			
H8/36032			
H8/36037F			
H8/36034F			
H8/36057			
H8/36054			
H8/36057F			
H8/36054F			

Note: Target in [Clock] and [SubClock] is only available when the target system is connected.

Table 8.4 Environment for the H8/36024 E6000 Emulator CPU 300H Debugging Platform

[Device] Option	[Clock] Option	[SubClock] Option	Expansion Hardware
Custom	The MCU previously selected		
H8/36024	1 MHz	Not available	HS36024EIO61H
H8/36022	10 MHz		
H8/36049	16 MHz	32.768 kHz	
H8/36048	Target	Target	
H8/36047			
H8/36049F			

Note: Target in [Clock] and [SubClock] is only available when the target system is connected.

Table 8.5 Environment for the H8/36109 E6000 Emulator CPU 300H Debugging Platform

[Device] Option	[Clock] Option	[SubClock] Option	Expansion Hardware
Custom	The MCU previously selected		
H8/36109F	1 MHz	32.768 kHz	HS36109EIO61H
H8/36109	10 MHz	Target	
H8/36108	16 MHz		
H8/36107	Target		

Note: Target in [Clock] and [SubClock] is only available when the target system is connected.

8.1.4 [Configuration Properties] Dialog Box ([Custom] Page)

Items that can be set in this dialog box are listed below.

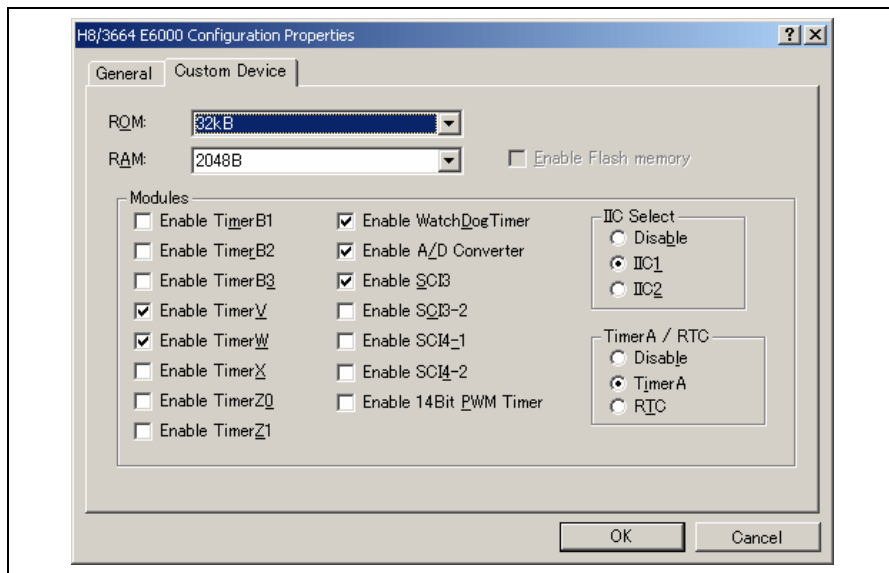

Figure 8.2 [Configuration Properties] Dialog Box ([Custom Device] Page)

[ROM]	<p>Specify the internal ROM area size.</p> <p>8kB: Sets the internal ROM area to be 8 kbytes (H'000000 to H'001FFF).</p> <p>12kB: Sets the internal ROM area to be 12 kbytes (H'000000 to H'002FFF).</p> <p>16kB: Sets the internal ROM area to be 16 kbytes (H'000000 to H'003FFF).</p> <p>24kB: Sets the internal ROM area to be 24 kbytes (H'000000 to H'005FFF).</p> <p>32kB: Sets the internal ROM area to be 32 kbytes (H'000000 to H'007FFF).</p> <p>40kB: Sets the internal ROM area to be 40 kbytes (H'000000 to H'009FFF).</p> <p>48kB: Sets the internal ROM area to be 48 kbytes (H'000000 to H'00BFFF).</p> <p>56kB: Sets the internal ROM area to be 56 kbytes (H'000000 to H'00DFFF).</p>
[RAM]	<p>Specify the internal RAM area size.</p> <p>512B: Sets the internal RAM area to be 512 bytes (H'FFFD80 to H'FFFF7F).</p> <p>1024B: Sets the internal RAM area to be 1024 bytes (H'FFFB80 to H'FFFF7F).</p> <p>1536B: Sets the internal RAM area to be 1536 bytes (H'FFF980 to H'FFFF7F).</p> <p>2048B: Sets the internal RAM area to be 2048 bytes (H'FFF780 to H'FFFF7F).</p> <p>3072B: Sets the internal RAM area to be 3072 bytes (H'FFEC00 to H'FFEFFF and H'FFF780 to H'FFFF7F).</p> <p>4096B: Sets the internal RAM area to be 4096 bytes (H'FFE800 to H'FFEFFF and H'FFF780 to H'FFFF7F).</p> <p>5120B: Sets the internal RAM area to be 5120 bytes (H'FFE400 to H'FFEFFF and H'FFF780 to H'FFFF7F).</p> <p>6144B: Sets the internal RAM area to be 6144 bytes (H'FFE000 to H'FFEFFF and H'FFF780 to H'FFFF7F).</p>

[Modules]

Check this box to validate on-chip peripherals.

Enable TimerB1: Enables timer B1.

Enable TimerB2: Enables timer B2.

Enable TimerB3: Enables timer B3.

Enable TimerV: Enables timer V.

Enable TimerW: Enables timer W.

Enable TimerX: Enables timer X.

Enable TimerZ0: Enables timer Z0.

Enable TimerZ1: Enables timer Z1.

Enable WatchDog Timer: Enables the watchdog timer.

Enable A/D Converter: Enables the A/D converter.

Enable SCI3: Enables SCI3.

Enable SCI3-2: Enables SCI3_2.

Enable SCI4-1: Enables SCI4_1.

Enable SCI4-2: Enables SCI4_2.

Enable 14Bit PWM Timer: Enables the 14-bit pulse width modulator.

IIC Select: Selects whether or not to enable IIC1 or IIC2.

Disable: Disables IIC1 and IIC2.

IIC1: Enables IIC1.

IIC2: Enables IIC2.

TimerA/RTC: Selects whether or not to enable timer A or RTC.

Disable: Disables timer A and RTC.

TimerA: Enables timer A.

RTC: Enables RTC.

8.1.5 Memory Mapping Function

The memory map cannot be changed with this emulator.

8.1.6 [Status] Window

Selecting [View -> CPU -> Status] or clicking the [Status Display] toolbar button displays the [Status] window. The [Status] window has three sheets. This emulator displays the following items.

(1) [Memory] Sheet

Selecting the [Memory] tab on the [Status] window displays this sheet.

Table 8.6 [Memory] Sheet Items

[Item] Column	[Status] Column
Target Device Configuration	Displays memory mapping.
System Memory Resources	Displays the memory resource of the emulator hardware.
Program Name	Displays the program file name.

(2) [Platform] Sheet

Selecting the [Platform] tab on the [Status] window displays this sheet.

Table 8.7 [Platform] Sheet Items

[Item] Column	[Status] Column
Connected To:	Displays emulator name (driver used).
CPU	Displays the target MCU name.
Clock source	Displays the selected clock.
Subclock source	Displays the selected sub-clock.
Run status	Displays the execution status. Break: The user program breaks Running: The user program is running
Cause of last break	Displays the cause of the emulator stopped at a break. If a program breaks in the sub-active state, '(SubActive)' will be displayed after the cause of the break. Ready: User program not executed (immediately after starting the High-performance Embedded Workshop) User Break: Break by the user Software Break: Break by software breakpoint On Chip Break A: Break by On Chip Break Complex Event System: Break by complex event system Stepping Completed: Break by stepping completed Stepping Aborted: Break by stepping aborted ROM Write Access Break: Break by writing to ROM Unused Area Access Break: Break by accessing to a guarded memory Performance Break: Break by Performance Analysis Invalid breakpoint: Break by a break instruction without Software Break
Event Time Count	Displays the measured result of the timer between events.
Run Time Count	Displays the total execution time of the program.

(3) [Events] Sheet

Selecting the [Events] tab on the [Status] window displays this sheet.

Table 8.8 [Events] Sheet Item

[Item] Column	[Status] Column
Resources	Displays the resource information and the information on events such as the breakpoint.

8.1.7 Extended Monitor Function

Selecting [View -> CPU -> Extended Monitor] or clicking the [Extended Monitor] toolbar button displays the [Extended Monitor] window. This emulator displays the following items.

Table 8.9 [Extended Monitor] Window Items

[Item] Column	[Value] Column
User NMI	Displays the status of the NMI pin.
User Reset	Displays the status of the reset pin.
User System Voltage	Displays whether or not the user VCC is equal to or exceeds the value set in [User VCC Threshold] on the [General] page of the [Configuration Properties] dialog box.
User Cable	Displays whether or not the user cable is connected.
Running status	<p>Displays the address bus value in the MCU and the status of the CPU while the user program is running, and the cause of a break while the user program is halted.</p> <p>Break = <Cause of break>: Displays the cause of a break.</p> <p>Address = <Address bus value>: Displays the address bus value during the user program execution. While in subactive mode, '(SubActive)' is displayed after the address bus value.</p> <p>Status = <Status of the CPU>: Displays the status of the CPU.</p> <p>PREFETCH: CPU instruction prefetch cycles DATA: CPU data access cycles SLEEP: Sleep mode STANDBY: Standby mode SUBSLEEP: Subslepp mode</p>
ROM Write	<p>Displays whether or not the ROM has been written to during the user program execution.</p> <p>Once the ROM has been written to, the state is retained until the Configure Platform is set again.</p>
Target Clock	Displays whether or not there is a clock signal to be input from the user system.

Note: In this emulator, the update interval in the [Extended Monitor] window cannot be selected or changed.

8.1.8 Signals to Indicate Bus States and Areas

The following tables show examples of signals to indicate the bus states and areas that can be acquired by the emulator.

Table 8.10 Bus State Signals Acquired by the Emulator

Bus State	Trace Display (Status)	Description
CPU Prefetch	PROG	CPU prefetch cycles
CPU Data	DATA	CPU data access cycles

Table 8.11 Area Signals Acquired by the Emulator

Area	Trace Display (Area)	Description
On-chip ROM	ROM	ROM
On-chip RAM	RAM	RAM
On-chip I/O 16bit	I/O-16	16-bit I/O
On-chip I/O 8bit	I/O-8	8-bit I/O

Note: The signals to indicate bus states and areas are used to set the [Bus/Area] condition of the event point. They can also be acquired as the trace information. The bus state signals are also used to set the condition not to acquire the trace ([Suppress] option) and in the Access Count Of Specified Range Measurement mode for measuring the hardware performance ([Access Type] option).

8.1.9 Monitoring Function

This emulator incorporates the bus monitoring circuit as the standard, which thus allows a use of the monitoring function to update the content of memory without affecting the realtime operation.

8.1.10 Trigger Points

This emulator incorporates the bus monitoring circuit as the standard, which thus allows a use of trigger points that can be set on the [Trigger] sheet in the [Event] window.

8.1.11 Trace Information

Selecting [View -> Code -> Trace] or clicking the [Trace] toolbar button displays the [Trace] window. Trace information that can be acquired by the emulator and trace information items to be displayed are as listed below.

[PTR]	Cycle number in the trace buffer. When the most recent record is record 0, earlier record numbers go backwards (-1, -2, ...). If a delay count has been set, the cycle number where the trace stop condition has been satisfied is record 0. For the cycle (during delay) executed until the trace has stopped, earlier record numbers go forward (+1, +2, ...) the most recent record.
[Address]	Address (6-digit hexadecimal)
[Instruction]	Disassembled code of the executed instruction
[Data]	Data bus value, displayed as 2-digit or 4-digit hexadecimal
[R/W]	Whether access was read (RD) or write (WR)
[Area]	Memory area being accessed; ROM, RAM, or 8- or 16-bit I/O (not available when a time stamp is acquired)
[Status]	Bus status during this cycle; PROG (prefetch) or Data (CPU data access cycle) (not available when a time stamp is acquired)
[Mode]	Operating mode; ACT (active) or SUB (subactive) (not available when a time stamp is acquired)
[Probes]	A 4-bit binary number showing the four probe pins in the order of Probe 4, Probe 3, Probe 2, and Probe 1 from the left (not available when a time stamp is acquired).
[NMI]	Status of the NMI input (not available when a time stamp is acquired)
[Timestamp]	Time stamp of the record. Time stamps start from zero each time the user program is executed. The timer resolution depends on the time stamp clock rate selected in the trace acquisition (only available when a time stamp is acquired).
[Source]	Source program
[Label]	Label information that corresponds to the address (if defined)
[Timestamp-Difference]	Difference from the timestamp value shown on the previous line (only available when a time stamp is acquired)

8.1.12 Searching for a Trace Record

While using the emulator, the [Trace Find] dialog box has the following pages:

Table 8.12 [Trace Find] Dialog Box Pages

Page	Description
[General]	Sets the range for searching.
[Address]	Sets an address condition.
[Data]	Sets a data condition.
[R/W]	Selects the type of access cycles.
[Area]	Selects the area being accessed (not available when a time stamp is acquired).
[Status]	Selects the status of a bus (not available when a time stamp is acquired).
[Probes]	Selects the status of four probe signals (not available when a time stamp is acquired).
[Timestamp]	Specify the time stamp value for bus cycles (only available when a time stamp is acquired).

8.1.13 Trace Filtering Function

While using the emulator, the [Trace Filter] dialog box has the following pages:

Table 8.13 [Trace Filter] Dialog Box Pages

Page	Description
[General]	Selects the range for filtering.
[Address]	Sets address conditions.
[Data]	Sets data conditions.
[R/W]	Selects the type of access cycles.
[Area]	Selects the area being accessed (not available when a time stamp is not acquired).
[Status]	Sets the status of a bus (not available when a time stamp is not acquired).
[Probes]	Selects the states of four probe signals (not available when a time stamp is not acquired).
[Timestamp]	Specifies the time stamp value for bus cycles (only available when a time stamp is acquired).

8.1.14 Reading from and Writing to the EEPROM

With this emulator, users can view and write to memory areas in the EEPROM. This section describes how to look at memory areas and how to fill and move a memory block.

(1) Viewing a Memory Area in the EEPROM

To look at a memory area in the EEPROM, choose [View -> CPU ->EEPROM...] or click the [EEPROM] toolbar button () to open the [EEPROM] window. This will open the [Properties] dialog box shown in figure 8.3.

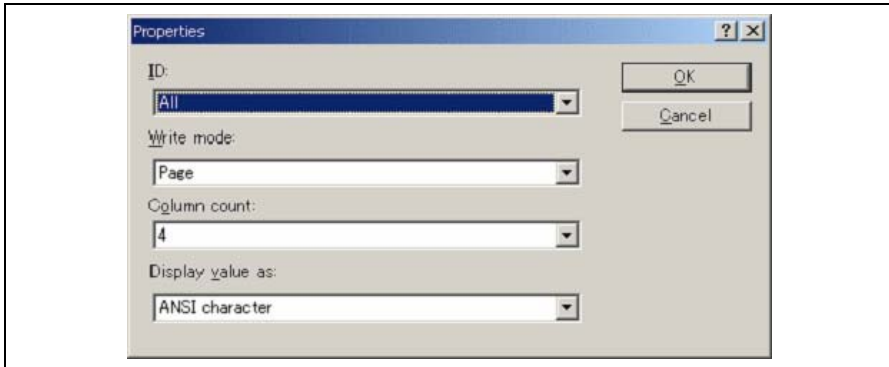

Figure 8.3 [Properties] Dialog Box

Select the range of slave addresses of the EEPROM you wish to display from the [ID] combo box. [All] displays all memory areas in the EEPROM incorporated in the emulator. Select mode to write to memory from the [Write mode] combo box. Then select the number of columns to be displayed in a row from the [Count column] combo box and the format for display of data from the [Display value as] combo box. Click the [OK] button or press the [Enter] key, and the dialog box closes and the [EEPROM] window opens. The display can be scrolled within the range of the selected slave addresses.

The screenshot shows a window titled "[EEPROM]" with a table of memory data. The table has five columns: "ID", "Add...", "8", "10", and "18", plus a "Value" column. The "ID" column lists addresses from 00 000000 to 00 0001E0 in increments of 00 000020. The "Add..." column is empty. The "8", "10", and "18" columns contain hexadecimal values (all shown as FFFFFFFF). The "Value" column contains a series of dots representing the data read from the EEPROM.

ID	Add...	8	10	18	Value
00 000000		FFFFFFFF	FFFFFFFF	FFFFFFFF	FFFFFFFF
00 000020		FFFFFFFF	FFFFFFFF	FFFFFFFF	FFFFFFFF
00 000040		FFFFFFFF	FFFFFFFF	FFFFFFFF	FFFFFFFF
00 000060		FFFFFFFF	FFFFFFFF	FFFFFFFF	FFFFFFFF
00 000080		FFFFFFFF	FFFFFFFF	FFFFFFFF	FFFFFFFF
00 0000A0		FFFFFFFF	FFFFFFFF	FFFFFFFF	FFFFFFFF
00 0000C0		FFFFFFFF	FFFFFFFF	FFFFFFFF	FFFFFFFF
00 0000E0		FFFFFFFF	FFFFFFFF	FFFFFFFF	FFFFFFFF
00 000100		FFFFFFFF	FFFFFFFF	FFFFFFFF	FFFFFFFF
00 000120		FFFFFFFF	FFFFFFFF	FFFFFFFF	FFFFFFFF
00 000140		FFFFFFFF	FFFFFFFF	FFFFFFFF	FFFFFFFF
00 000160		FFFFFFFF	FFFFFFFF	FFFFFFFF	FFFFFFFF
00 000180		FFFFFFFF	FFFFFFFF	FFFFFFFF	FFFFFFFF
00 0001A0		FFFFFFFF	FFFFFFFF	FFFFFFFF	FFFFFFFF
00 0001C0		FFFFFFFF	FFFFFFFF	FFFFFFFF	FFFFFFFF
00 0001E0		FFFFFFFF	FFFFFFFF	FFFFFFFF	FFFFFFFF

Figure 8.4 [EEPROM] Window

The [EEPROM] window has [ID], [Address], [Value], and data columns. The number of data columns is that selected in the [Column count] combo box. Each of the columns is displayed in hexadecimal.

[ID]: Slave address of the EEPROM.

[Address]: Address of the first item in the data columns of this row.

Data: Data is read from the EEPROM, and then converted to the display width.

[Value]: Data displayed in an alternative format.

(2) Viewing a Different Memory Area

To change the memory area displayed in the [EEPROM] window, use the [Properties] dialog box. This box can be opened by choosing [Properties...] from the popup menu.

Select the new slave address value, and click the [OK] button or press the [Enter] key. The dialog box closes and the [EEPROM] window display is updated with the data at the new address.

(3) Modifying the Memory Contents

The memory contents can be modified via the [Edit] dialog box. The contents of the EEPROM are changed in byte or page units, depending on the mode selected in the [Write mode] combo box of the [Properties] dialog box. Move the cursor on the column that you wish to change and select [Edit...] from the popup menu.

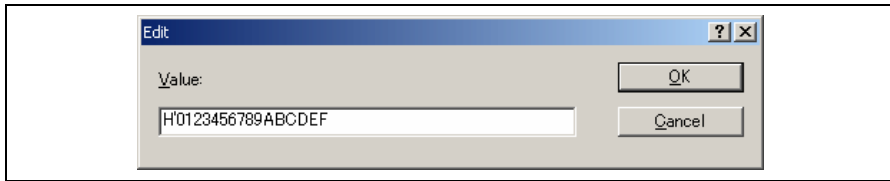

Figure 8.5 [Edit] Dialog Box

A number can be entered in the [Value] field. After you have entered the new number, click the [OK] button or press the [Enter] key. Then the dialog box closes and the new value is written into memory.

The memory contents can also be modified by moving the cursor on a data column and entering the new value in hexadecimal through the keyboard.

(4) Selecting a Memory Range

You can select a range by clicking on the first data column and dragging the mouse to the last column. The selected range is highlighted.

(5) Filling a Memory Area with a Value

A value can be set as the content of a memory address range using the memory fill function.

To fill a memory range with the same value, choose [Fill...] from the popup menu of the [EEPROM] window. The [Fill] dialog box is shown in figure 8.6.

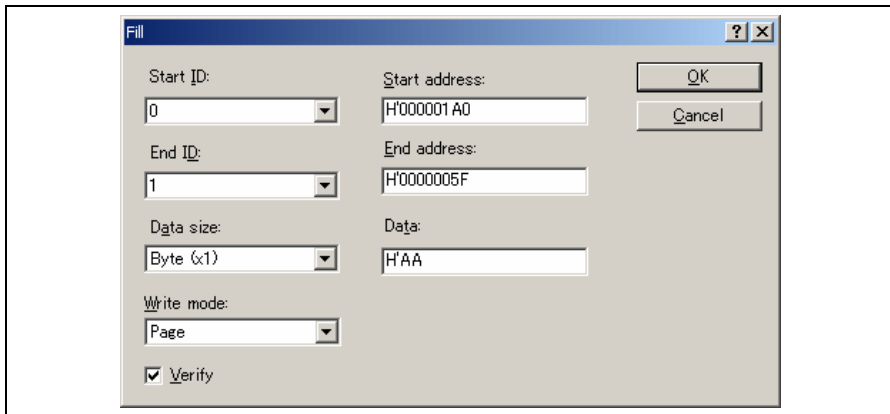

Figure 8.6 [Fill] Dialog Box

If an address range has been selected in the [EEPROM] window, the specified start and end slave addresses and the start and end addresses will be displayed. Select a format from the [Data size] combo box and enter the data value in the [Data] field. Then select a mode for writing from the [Write mode] combo box.

Checking the [Verify] check box allows comparison of memory contents before setting these values. On clicking the [OK] button or pressing the [Enter] key, the dialog box closes and the new value is written into the memory range.

(6) Copying a Memory Area

You can copy a memory area using the memory copy function. The following three types are available:

- From EEPROM to EEPROM
- From EEPROM to normal memory
- From normal memory to EEPROM

(a) From EEPROM to EEPROM

Selecting a memory range and then [Copy...] from the popup menu opens the [Copy] dialog box (figure 8.7). Select the [EEPROM -> EEPROM] toggle button in the [Copy Direction] group box.

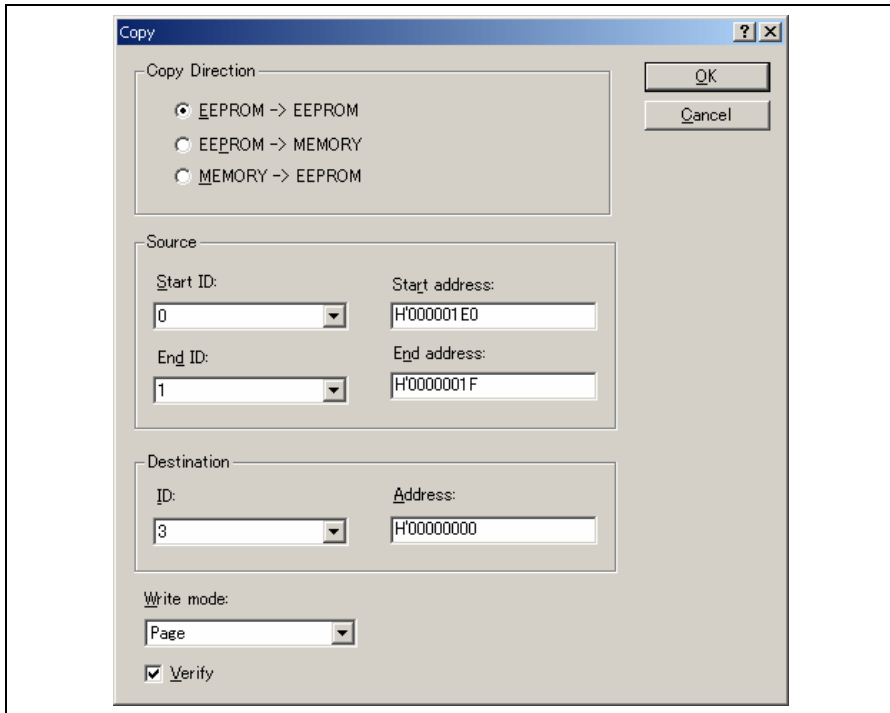

Figure 8.7 [Copy] Dialog Box (EEPROM -> EEPROM)

The start slave address and end slave address as the source selected in the [EEPROM] window will be displayed in the [Start ID] and [End ID] combo boxes. The source start address and end address will be displayed in the [Start address] and [End address] fields. Checking the [Verify] check box enables copying while comparing the copy source and copy destination. The copy unit can be selected in the [Write mode] combo box. As the destination, select the start slave address from the [ID] combo box and enter the start address value in the [Address] field of the [Destination] group box, respectively. Then click the [OK] button or press the [Enter] key. This will close the dialog box and copy the memory block to the new address.

(b) From EEPROM to normal memory

Selecting a memory range and then [Copy...] from the popup menu opens the [Copy] dialog box (figure 8.8). Select the [EEPROM -> MEMORY] toggle button in the [Copy Direction] group box.

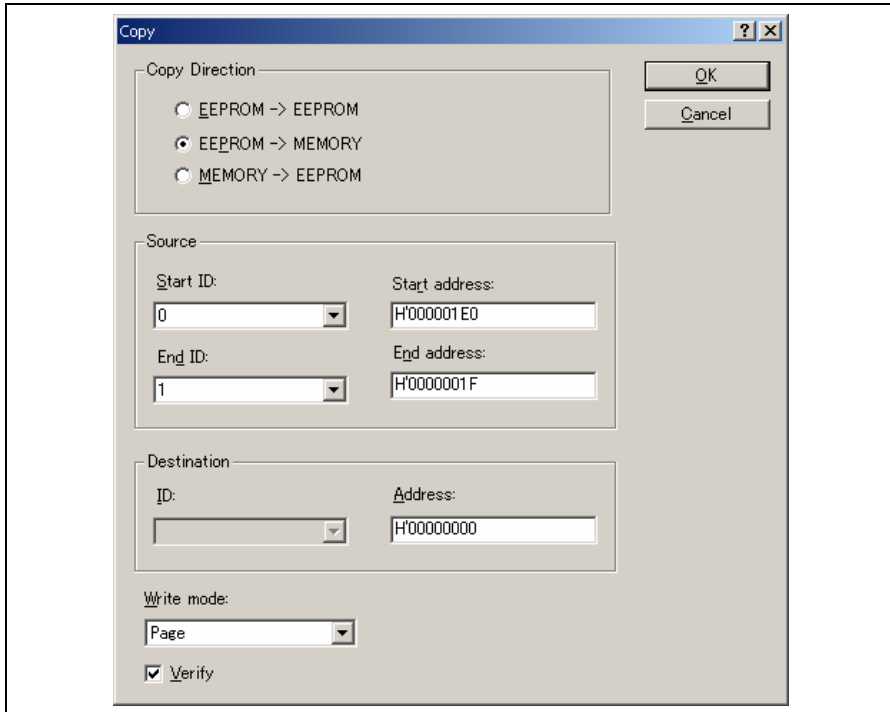

Figure 8.8 [Copy] Dialog Box (EEPROM -> MEMORY)

The start slave address and end slave address as the source selected in the [EEPROM] window will be displayed in the [Start ID] and [End ID] combo boxes. The source start address and end address will be displayed in the [Start address] and [End address] fields. Checking the [Verify] check box enables copying while comparing the copy source and copy destination. The copy unit can be selected in the [Write mode] combo box. Enter the start address value of the destination in normal memory in the [Address] field of the [Destination] group box. Then click the [OK] button or press the [Enter] key. This will close the dialog box and copy the memory block to the specified address in normal memory.

(c) From normal memory to EEPROM

Selecting a memory range and then [Copy...] from the popup menu opens the [Copy] dialog box (figure 8.9). Select the [MEMORY -> EEPROM] toggle button in the [Copy Direction] group box.

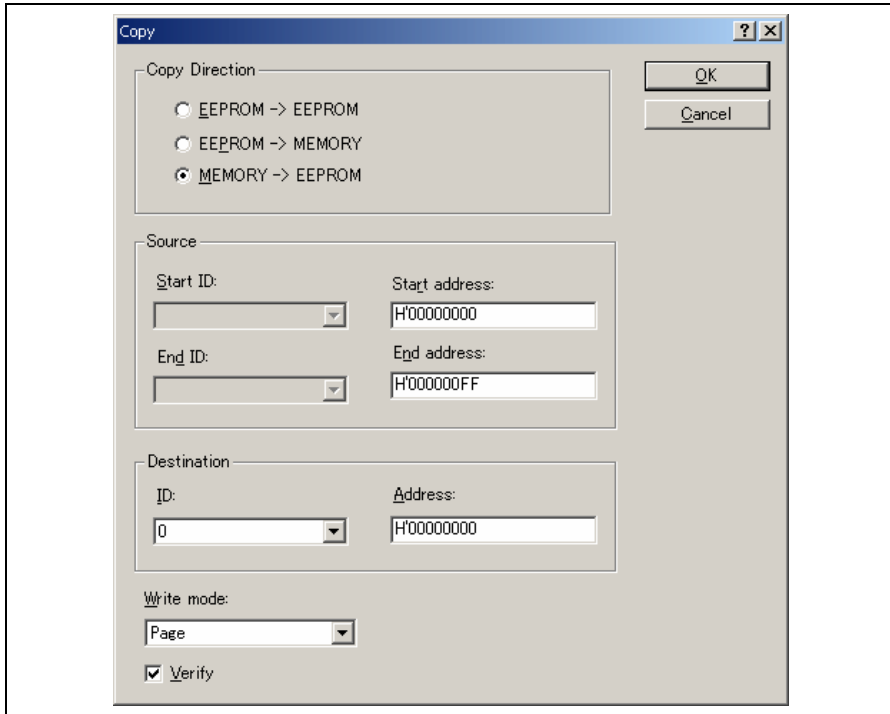

Figure 8.9 [Copy] Dialog Box (MEMORY -> EEPROM)

Enter the source start address and end address in normal memory in the [Start address] and [End address] fields. Checking the [Verify] check box enables copying while comparing the copy source and copy destination. The copy unit can be selected in the [Write mode] combo box. As the destination, select the start slave address from the [ID] combo box and enter the start address value in the [Address] field of the [Destination] group box, respectively. Then click the [OK] button or press the [Enter] key. This will close the dialog box and copy the memory block to the new address.

(7) Disabling Update of the Window Contents

Automatic update of the [EEPROM] window contents, which is performed when user program execution stops or in other cases, can be disabled. This is done by checking [Lock Refresh] in the popup menu.

(8) Updating the Window Contents

The [EEPROM] window contents can be forcibly updated. This is done by checking [Refresh] in the popup menu.

8.2 Notes on Usage of the H8/3664 E6000 Emulator

There are the following notes on usage of the emulator.

8.2.1 I/O Register

In the E6000 emulator, one evaluation chip emulates several types of MCU. Therefore, there are some differences in I/O registers between an actual MCU and the emulator. Note these differences when accessing the I/O registers.

I/O port is in the input state at default. The I/O register contents indicate the emulator port status. When the user system interface cable is not connected, the read value is 1 due to pull-up resistors.

In the emulator, accesses to the following registers for controlling the flash memory are invalid.

- Flash memory control register 1 (FLMCR1: H'FF90)
- Flash memory control register 2 (FLMCR2: H'FF91)
- Flash memory power control register (FLPWCR: H'FF92)
- Block register 1 (EBR1: H'FF93)
- Flash memory enable register (FENR: H'FF9B)

Note: The addresses indicate the lower 16 bits.

(1) Warnings that Apply to H8/3664 Group Programming

- (a) The description given in the hardware manual is “Initial value: 1. Reserved. These bits are always read as 1”. However, the description in the emulator manual is “Always specify 0. These bits are always read as the specified values”.

Table 8.14 Differences between the H8/3664 Group Products (1)

Target Address	Register Name	Bits
H'FFE0	Port mode register 1	3 and 2

- (b) The description given in the hardware manual is “Initial value: 0. Reserved. These bits are always read as 0”. However, the description in the emulator manual is “Always specify 0. These bits are always read as the specified values”.

Table 8.15 Differences between the H8/3664 Group Products (2)

Target Address	Register Name	Bits
H'FFE1	Port mode register 5	7 and 6
H'FFF9	Module standby control register 1	7

- (c) The description given in the hardware manual is “Reserved”. However, the description in the emulator manual is “Always specify 0. These bits are always read as the specified values”.

Table 8.16 Differences between the H8/3664 Group Products (3)

Target Address	Register Name	Bits
H'FFE2	Port mode register 3	7 to 3
H'FFF5	Interrupt enable register 2	7 to 5
H'FFFA	Module standby control register 2	7 to 0
H'FFFB	Module standby control register 3	0

(2) Warnings that Apply to H8/3672 Group Programming

- (a) The description given in the hardware manual is “Initial value: 1. Reserved. These bits are always read as 1”. However, the description in the emulator manual is “Always specify 0. These bits are always read as the specified values”.

Table 8.17 Differences between the H8/3672 Group Products (1)

Target Address	Register Name	Bits
H'FFE0	Port mode register 1	3

- (b) The description given in the hardware manual is “Initial value: 0. Reserved. These bits are always read as 0”. However, the description in the emulator manual is “Always specify 0. These bits are always read as the specified values”.

Table 8.18 Differences between the H8/3672 Group Products (2)

Target Address	Register Name	Bits
H'FFE0	Port mode register 1	6 and 5
H'FFF1	System control register 2	6, 1, and 0
H'FFF2	Interrupt edge select register 1	7, 2 and 1
H'FFF4	Interrupt enable register 1	6, 2 and 1
H'FFF9	Module standby control register 1	7

- (c) The description given in the hardware manual is “Reserved”. However, the description in the emulator manual is “Always specify 0. These bits are always read as the specified values”.

Table 8.19 Differences between the H8/3672 Group Products (3)

Target Address	Register Name	Bits
H'FFE2	Port mode register 3	7 to 3
H'FFF5	Interrupt enable register 2	7 to 5
H'FFFA	Module standby control register 2	7 to 0
H'FFFB	Module standby control register 3	0

Table 8.20 Differences between the Evaluation Chip and the H8/3664, H8/3672 Group Products

	Address	Register	Bit 7	Bit 6	Bit 5	Bit 4	Bit 3	Bit 2	Bit 1	Bit 0
H8/3660 (Evaluation chip)	H'FFE0	PMR1	IRQ3	IRQ2	IRQ1	IRQ0	TXD2	PWM	TXD	TMOW
	H'FFE1	PMR5	POF57	POF56	WKP5	WKP4	WKP3	WKP2	WKP1	WKP0
	H'FFE2	PMR3	POF27	POF26	POF25	POF24	POF23	—	—	—
	H'FFF1	SYSCR2	SMSSEL	LSON	DTON	MA2	MA1	MA0	SA1	SA0
	H'FFF2	IEGR1	NMIEG	—	—	—	IEG3	IEG2	IEG1	IEG0
	H'FFF4	IENR1	IENDT	IENTA	IENWP	—	IEN3	IEN2	IEN1	IEN0
	H'FFF5	IENR2	IENB3	IENB2	IENB1	—	—	—	—	—
	H'FFF9	MSTCR1	MSTS4	MSTIIC	MSTS3	MSTAD	MSTWD	MSTTW	MSTTV	MSTTA
	H'FFFA	MSTCR2	MSTS3_2	MSTTB3	MSTTB2	MSTTB1	MSTTX	—	MSTTZ0	MSTPWM
	H'FFFB	MSTCR3	—	—	—	—	—	—	—	MSTS4_2

	Address	Register	Bit 7	Bit 6	Bit 5	Bit 4	Bit 3	Bit 2	Bit 1	Bit 0
H8/3664	H'FFE0	PMR1	IRQ3	IRQ2	IRQ1	IRQ0	—	—	TXD	TMOW
	H'FFE1	PMR5	—	—	WKP5	WKP4	WKP3	WKP2	WKP1	WKP0
	H'FFE2	—	—	—	—	—	—	—	—	—
	H'FFF1	SYSCR2	SMSSEL	LSON	DTON	MA2	MA1	MA0	SA1	SA0
	H'FFF2	IEGR1	NMIEG	—	—	—	IEG3	IEG2	IEG1	IEG0
	H'FFF4	IENR1	IENDT	IENTA	IENWP	—	IEN3	IEN2	IEN1	IEN0
	H'FFF5	—	—	—	—	—	—	—	—	—
	H'FFF9	MSTCR1	—	MSTIIC	MSTS3	MSTAD	MSTWD	MSTTW	MSTTV	MSTTA
	H'FFFA	—	—	—	—	—	—	—	—	—
	H'FFFB	—	—	—	—	—	—	—	—	—

	Address	Register	Bit 7	Bit 6	Bit 5	Bit 4	Bit 3	Bit 2	Bit 1	Bit 0
H8/3672	H'FFE0	PMR1	IRQ3	—	—	IRQ0	—	—	TXD	—
	H'FFE1	PMR5	POF57	POF56	WKP5	WKP4	WKP3	WKP2	WKP1	WKP0
	H'FFE2	—	—	—	—	—	—	—	—	—
	H'FFF1	SYSCR2	SMSSEL	—	DTON	MA2	MA1	MA0	—	—
	H'FFF2	IEGR1	—	—	—	—	IEG3	—	—	IEG0
	H'FFF4	IENR1	IENDT	—	IENWP	—	IEN3	—	—	IEN0
	H'FFF5	—	—	—	—	—	—	—	—	—
	H'FFF9	MSTCR1	—	—	MSTS3	MSTAD	MSTWD	MSTTW	MSTTV	—
	H'FFFA	—	—	—	—	—	—	—	—	—
	H'FFFB	—	—	—	—	—	—	—	—	—

(3) Warnings that Apply to H8/3687, H8/36077, H8/36079 Group Programming

- (a) The description given in the hardware manual is “Initial value: 0. Reserved. These bits are always read as 1, and cannot be modified”. However, the description in the emulator manual is “Always specify 0. These bits are always read as the specified values”.

Table 8.21 Differences between the H8/3687 Group Products (1)

Target Address	Register Name	Bits
H'FFE2	Port mode register 3	7 to 5
H'FFF5	Interrupt enable register 2	7 and 6
H'FFF9	Module standby control register 1	7 and 2
H'FFFA	Module standby control register 2	6, 5, and 3

- (b) The description given in the hardware manual is “Reserved”. However, the description in the emulator manual is “Always specify 0. These bits are always read as the specified values”.

Table 8.22 Differences between the H8/3687 Group Products (2)

Target Address	Register Name	Bits
H'FFFB	Module standby control register 3	0

- (c) The hardware manual shows registers at the addresses given below. For these locations, however, the applicable description in the emulator manual is “Writing has no effect. These bits are always read as undefined values”, because there are no registers at these locations of the emulator.

Table 8.23.1 Differences between the H8/3687 Group Products (3-1)

Target Address	Register Name	Bits
H'F730	Low-voltage-detection control register	7 to 0
H'F731	Low-voltage-detection status register	7 to 0

Table 8.23.2 Differences between the H8/36077, H8/36079 Group Products (3-2)

Target Address	Register Name	Bits
H'F730	Low-voltage-detection control register	7 to 0
H'F731	Low-voltage-detection status register	7 to 0
H'F732	Reset factor register	7 to 0

- (d) The H8/3687, H8/36077, H8/36079 group has power-on reset and optional low-voltage detection circuit functions. However, the E6000 emulator does not support these functions.

Table 8.24 Differences between the Evaluation Chip and the H8/3687 Registers

	Address	Register	Bit 7	Bit 6	Bit 5	Bit 4	Bit 3	Bit 2	Bit 1	Bit 0
H8/3660 (Evaluation chip)	H'F72C	RTCCR2	RUN	12/24	PM	RST				
	H'F730									
	H'F731									
	H'F732									
	H'FFDE	PDR3	PDR7	PDR6	PDR5	PDR4	PDR3	PDR2	PDR1	PDR0
	H'FFE2	PMR3	POF27	POF26	POF25	POF24	POF23			
	H'FFEE	PCRC	PCRC7	PCRC6	PCRC5	PCRC4	PCRC3	PCRC2	PCRC1	PCRC0
	H'FFF5	IENR2	IENB3	IENB2	IENB1					
	H'FFF9	MSTCR1	MSTS4	MSTIIC	MSTS3	MSTAD	MSTWD	MSTTW	MSTTV	MSTTA
	H'FFFA	MSTCR2	MSTS3_2	MSTTB3	MSTTB2	MSTTB1	MSTTX		MSTTZ	MSTPWM
H'FFFB	MSTCR3								MSTS4_2	

	Address	Register	Bit 7	Bit 6	Bit 5	Bit 4	Bit 3	Bit 2	Bit 1	Bit 0
H8/3687	H'F72C	RTCCR2	RUN	12/24	PM	RST				
	H'F730	LVDCR	LVDE				LVDSSEL	LVDSRE	LVDSDE	LVDSUE
	H'F731	LVDSR							LVDSDF	LVDSUF
	H'F732									
	H'FFDE									
	H'FFE2	PMR3				POF24	POF23			
	H'FFEE									
	H'FFF5	IENR2			IENB1					
	H'FFF9	MSTCR1		MSTIIC	MSTS3	MSTAD	MSTWD		MSTTV	MSTTA
	H'FFFA	MSTCR2	MSTS3_2			MSTTB1			MSTTZ	MSTPWM
H'FFFB										

	Address	Register	Bit 7	Bit 6	Bit 5	Bit 4	Bit 3	Bit 2	Bit 1	Bit 0
H8/36077 H8/36079	H'F72C	RTCCR2	RUN	12/24	PM	RST	INT			
	H'F730	LVDCR			VDDII		LVDSSEL		LVDSDE	LVDSUE
	H'F731	LVDSR							LVDSDF	LVDSUF
	H'F732	LVDRF							PRST	WRST
	H'FFDE	PDR3							PDR1	PDR0
	H'FFE2	PMR3				POF24	POF23			
	H'FFEE	PCRC							PCRC1	PCRC0
	H'FFF5	IENR2			IENB1					
	H'FFF9	MSTCR1		MSTIIC	MSTS3	MSTAD	MSTWD		MSTTV	MSTTA
	H'FFFA	MSTCR2	MSTS3_2			MSTTB1			MSTTZ	MSTPWM
H'FFFB										

(4) Warnings that Apply to H8/3694 Group Programming

- (a) The description given in the hardware manual is “Initial value: 1. Reserved. These bits are always read as 1, and cannot be modified”. However, the description in the emulator manual is “Always specify 0. These bits are always read as the specified values”.

Table 8.25 Differences between the H8/3694 Group Products (1)

Target Address	Register Name	Bits
H'FFE0	Port mode register 1	3 and 2

- (b) The description given in the hardware manual is “Initial value: 0. Reserved. These bits are always read as 0, and cannot be modified”. However, the description in the emulator manual is “Always specify 0. These bits are always read as the specified values”.

Table 8.26 Differences between the H8/3694 Group Products (2)

Target Address	Register Name	Bits
H'FFE1	Port mode register 5	7 and 6
H'FFF9	Module standby control register 1	7

- (c) The description given in the hardware manual is “Reserved”. However, the description in the emulator manual is “Always specify 0. These bits are always read as the specified values”.

Table 8.27 Differences between the H8/3694 Group Products (3)

Target Address	Register Name	Bits
H'FFE2	Port mode register 3	7 to 3
H'FFF5	Interrupt enable register 2	7 to 5
H'FFFA	Module standby control register 2	7 to 0
H'FFFB	Module standby control register 3	0

- (d) The hardware manual shows registers at the addresses given below. For these locations, however, the applicable description in the emulator manual is “Writing has no effect. These bits are always read as undefined values”, because there are no registers at these locations of the emulator.

Table 8.28 Differences between the H8/3694 Group Products (4)

Target Address	Register Name	Bits
H'F730	Low-voltage-detection control register	7 to 0
H'F731	Low-voltage-detection control register	7 to 0

- (e) The H8/3694 group has power-on reset and optional low-voltage detection circuit functions. However, the E6000 emulator does not support these functions.

Table 8.29 Differences between the Evaluation Chip and the H8/3694 Registers

	Address	Register	Bit 7	Bit 6	Bit 5	Bit 4	Bit 3	Bit 2	Bit 1	Bit 0
H8/3660 (Evaluation chip)	H'F730	—	—	—	—	—	—	—	—	—
	H'F731	—	—	—	—	—	—	—	—	—
	H'FFE0	PMR1	IRQ3	IRQ2	IRQ1	IRQ0	TXD2	PWM	TXD	TMOW
	H'FFE1	PMR5	POF57	POF56	WKP5	WKP4	WKP3	WKP2	WKP1	WKP0
	H'FFE2	PMR3	POF27	POF26	POF25	POF24	POF23	—	—	—
	H'FFF1	SYSCR2	SMSSEL	LSON	DTON	MA2	MA1	MA0	SA1	SA0
	H'FFF2	IEGR1	NMIEG	—	—	—	IEG3	IEG2	IEG1	IEG0
	H'FFF4	IENR1	IENDT	IENTA	IENWP	—	IEN3	IEN2	IEN1	IEN0
	H'FFF5	IENR2	IENB3	IENB2	IENB1	—	—	—	—	—
	H'FFF9	MSTCR1	MSTS4	MSTIIC	MSTS3	MSTAD	MSTWD	MSTTW	MSTTV	MSTTA
	H'FFFA	MSTCR2	MSTS3_2	MSTTB3	MSTTB2	MSTTB1	MSTTX	—	MSTTZ0	MSTPWM
	H'FFFB	MSTCR3	—	—	—	—	—	—	—	MSTS4_2

	Address	Register	Bit 7	Bit 6	Bit 5	Bit 4	Bit 3	Bit 2	Bit 1	Bit 0
H8/3694	H'F730	LVDCR	LVDE	—	—	—	LVDSEL	LVDRE	LVDEE	LVDUE
	H'F731	LVDSR	—	—	—	—	—	—	LVDDF	LVDUF
	H'FFE0	PMR1	IRQ3	IRQ2	IRQ1	IRQ0	—	—	TXD	TMOW
	H'FFE1	PMR5	—	—	WKP5	WKP4	WKP3	WKP2	WKP1	WKP0
	H'FFE2	—	—	—	—	—	—	—	—	—
	H'FFF1	SYSCR2	SMSSEL	LSON	DTON	MA2	MA1	MA0	SA1	SA0
	H'FFF2	IEGR1	NMIEG	—	—	—	IEG3	IEG2	IEG1	IEG0
	H'FFF4	IENR1	IENDT	IENTA	IENWP	—	IEN3	IEN2	IEN1	IEN0
	H'FFF5	—	—	—	—	—	—	—	—	—
	H'FFF9	MSTCR1	—	MSTIIC	MSTS3	MSTAD	MSTWD	MSTTW	MSTTV	MSTTA
	H'FFFA	—	—	—	—	—	—	—	—	—
	H'FFFB	—	—	—	—	—	—	—	—	—

(5) Warnings that Apply to H8/36014, H8/36024 Group Programming

- (a) The description given in the hardware manual is “Initial value: 0. Reserved. These bits are always read as 0”. However, the description in the emulator manual is “Always specify 0. These bits are always read as the specified values”.

Table 8.30 Differences between the H8/36014, H8/36024 Group Products (1)

Target Address	Register Name	Bits
H'FFE0	Port mode register 1	6, 5, 2, and 0
H'FFF1	System control register 2	6, 1, and 0
H'FFF2	Interrupt edge select register 1	7, 2, and 1
H'FFF4	Interrupt enable register 1	6, 2, and 1
H'FFF9	Module standby control register 1	7 and 0
H'FFFA	Module standby control register 2	6 to 0

- (b) The description given in the hardware manual is “Reserved”. However, the description in the emulator manual is “Always specify 0. These bits are always read as the specified values”.

Table 8.31 Differences between the H8/36014, H8/36024 Group Products (2)

Target Address	Register Name	Bits
H'FFE2	Port mode register 3	7 to 3
H'FFF5	Interrupt enable register 2	7 to 5
H'FFFB	Module standby control register 3	0

- (c) The hardware manual shows registers at the addresses given below. For these locations, however, the applicable description in the emulator manual is “Writing has no effect. These bits are always read as undefined values”, because there are no registers at these locations of the emulator.

Table 8.32 Differences between the H8/36014, H8/36024 Group Products (3)

Target Address	Register Name	Bits
H'F730	Low-voltage-detection control register	7 to 0
H'F731	Low-voltage-detection status register	7 to 0

- (d) The H8/36014, H8/36024 group has power-on reset and optional low-voltage detection circuit functions. However, the E6000 emulator does not support these functions.
- (e) While emulating the H8/36024 group, set PCR1 and PCR5 to '0' if you want to use SCI3_3.

- (f) While emulating the H8/36024 group, note that the register specifications at address H'F608 in the actual device and expansion I/O board (HS36024EIO61H) are different. Table 8.32 lists the specifications and note on them.

Table 8.33 Register Specifications and Note

Item	Register Specifications	Note
HS36024EIO61H	Bits 4 to 7 (1111): Reserved Bit 3 (0): Selects the device (0: H8/36024) Bit 2 (0): Selects whether or not to delete noise (0: no, 1: yes) Bit 1 (0): Selects the TXD3 output (0: port, 1: TXD_3) Bit 0 (0): Selects whether or not to stop modules (0: operate, 1: stop)	None
H8/36024	Bits 4 to 7 (1111): Reserved Bit 3 (1): Reserved (always read as 1 and writing has no effect) Bit 2 (1): Reserved (always read as 1 and writing has no effect) Bit 1 (0): Selects the TXD3 output (0: port, 1: TXD_3) Bit 0 (0): Selects whether or not to stop modules (0: operate, 1: stop)	For emulation with the expansion I/O board (HS36024EIO61H), set bits 2 and 3 to '0'.

Note: The value in parentheses indicates the initial value after a reset.

Table 8.34 Differences between the Evaluation Chip and the H8/36014, H8/36024 Registers

	Address	Register	Bit 7	Bit 6	Bit 5	Bit 4	Bit 3	Bit 2	Bit 1	Bit 0
H8/3660 (Evaluation chip)	H'F730	—	—	—	—	—	—	—	—	—
	H'F731	—	—	—	—	—	—	—	—	—
	H'FFE0	PMR1	IRQ3	IRQ2	IRQ1	IRQ0	TXD2	PWM	TXD	TMOW
	H'FFE1	PMR5	POF57	POF56	WKP5	WKP4	WKP3	WKP2	WKP1	WKP0
	H'FFE2	PMR3	POF27	POF26	POF25	POF24	POF23	—	—	—
	H'FFF1	SYSCR2	SMSSEL	LSON	DTON	MA2	MA1	MA0	SA1	SA0
	H'FFF2	IEGR1	NMIEG	—	—	—	IEG3	IEG2	IEG1	IEG0
	H'FFF4	IENR1	IENDT	IENTA	IENWP	—	IEN3	IEN2	IEN1	IEN0
	H'FFF5	IENR2	IENTB3	IENTB2	IENTB1	—	—	—	—	—
	H'FFF9	MSTCR1	MSTS4	MSTIIC	MSTS3	MSTAD	MSTWD	MSTTW	MSTTV	MSTTA
	H'FFFA	MSTCR2	MSTS3_2	MSTTB3	MSTTB2	MSTTB1	MSTTX	—	MSTTZ0	MSTPWM
	H'FFFB	MSTCR3	—	—	—	—	—	—	—	MSTS4_2

	Address	Register	Bit 7	Bit 6	Bit 5	Bit 4	Bit 3	Bit 2	Bit 1	Bit 0
H8/36014 H8/36024	H'F730	LVDCR	LVDE	—	—	—	LVDSEL	LVDRE	LVDDDE	LVDDUE
	H'F731	LVDSR	—	—	—	—	—	—	LVDDDF	LVDDUF
	H'FFE0	PMR1	IRQ3	—	—	IRQ0	TXD2	—	TXD	—
	H'FFE1	PMR5	POF57	POF56	WKP5	WKP4	WKP3	WKP2	WKP1	WKP0
	H'FFE2	—	—	—	—	—	—	—	—	—
	H'FFF1	SYSCR2	SMSSEL	—	DTON	MA2	MA1	MA0	—	—
	H'FFF2	IEGR1	—	—	—	—	IEG3	—	—	IEG0
	H'FFF4	IENR1	IENDT	—	IENWP	—	IEN3	—	—	IEN0
	H'FFF5	—	—	—	—	—	—	—	—	—
	H'FFF9	MSTCR1	—	—	MSTS3	MSTAD	MSTWD	MSTTW	MSTTV	—
	H'FFFA	MSTCR2	MSTS3_2	—	—	—	—	—	—	—
H'FFFB	—	—	—	—	—	—	—	—	—	

(6) Warnings that Apply to H8/36037, H8/36057 Group Programming

- (a) The description given in the hardware manual is “Initial value: 0. Reserved. These bits are always read as 0”. However, the description in the emulator manual is “Always specify 0. These bits are always read as the specified values”.

Table 8.35 Differences between the H8/36037, H8/36057 Group Products (1)

Target Address	Register Name	Bits
H'FFE0	Port mode register 1	2 and 0
H'FFF4	Interrupt enable register 1	6
H'FFF5	Interrupt enable register 2	7 and 6
H'FFF9	Module standby control register 1	7, 6, 2, and 0
H'FFFA	Module standby control register 2	6, 5, and 3

- (b) The description given in the hardware manual is “Reserved”. However, the description in the emulator manual is “Always specify 0. These bits are always read as the specified values”.

Table 8.36 Differences between the H8/36037, H8/36057 Group Products (2)

Target Address	Register Name	Bits
H'FFE2	Port mode register 3	7 to 5
H'FFFB	Module standby control register 3	0

- (c) The hardware manual shows registers at the addresses given below. For these locations, however, the applicable description in the emulator manual is “Writing has no effect. These bits are always read as undefined values”, because there are no registers at these locations of the emulator.

Table 8.37 Differences between the H8/36037, H8/36057 Group Products (3)

Target Address	Register Name	Bits
H'F730	Low-voltage-detection control register	7 to 0
H'F731	Low-voltage-detection status register	7 to 0

- (d) The H8/36037, H8/36057 group has power-on reset and optional low-voltage detection circuit functions. However, the E6000 emulator does not support these functions.

(e) While emulating the H8/36037, H8/36057 group, set PCR9 to '0' if you want to use TinyHCAN or SSU.

Table 8.38 Differences between the Evaluation Chip and the H8/36037, H8/36057 Registers

	Address	Register	Bit 7	Bit 6	Bit 5	Bit 4	Bit 3	Bit 2	Bit 1	Bit 0
H8/3660 (Evaluation chip)	H'F730	—	—	—	—	—	—	—	—	—
	H'F731	—	—	—	—	—	—	—	—	—
	H'FFE0	PMR1	IRQ3	IRQ2	IRQ1	IRQ0	TXD2	PWM	TXD	TMOW
	H'FFE1	PMR5	POF57	POF56	WKP5	WKP4	WKP3	WKP2	WKP1	WKP0
	H'FFE2	PMR3	POF27	POF26	POF25	POF24	POF23	—	—	—
	H'FFF1	SYSCR2	SMSSEL	LSON	DTON	MA2	MA1	MA0	SA1	SA0
	H'FFF2	IEGR1	NMIEG	—	—	—	IEG3	IEG2	IEG1	IEG0
	H'FFF4	IENR1	IENDT	IENTA	IENWP	—	IEN3	IEN2	IEN1	IEN0
	H'FFF5	IENR2	IENB3	IENB2	IENB1	—	—	—	—	—
	H'FFF9	MSTCR1	MSTS4	MSTIIC	MSTS3	MSTAD	MSTWD	MSTTW	MSTTV	MSTTA
	H'FFFA	MSTCR2	MSTS3_2	MSTTB3	MSTTB2	MSTTB1	MSTTX	—	MSTTZ0	MSTPWM
	H'FFFB	MSTCR3	—	—	—	—	—	—	—	MSTS4_2

	Address	Register	Bit 7	Bit 6	Bit 5	Bit 4	Bit 3	Bit 2	Bit 1	Bit 0
H8/36037 H8/36057	H'F730	LVDCR	LVDE	—	—	—	LVDSEL	LVDRE	LVDDE	LVDUE
	H'F731	LVDSR	—	—	—	—	—	—	LVDDF	LVDUF
	H'FFE0	PMR1	IRQ3	IRQ2	IRQ1	IRQ0	TXD2	—	TXD	—
	H'FFE1	PMR5	POF57	POF56	WKP5	WKP4	WKP3	WKP2	WKP1	WKP0
	H'FFE2	PMR3	—	—	—	POF24	POF23	—	—	—
	H'FFF1	SYSCR2	SMSSEL	LSON	DTON	MA2	MA1	MA0	SA1	SA0
	H'FFF2	IEGR1	NMIEG	—	—	—	IEG3	IEG2	IEG1	IEG0
	H'FFF4	IENR1	IENDT	—	IENWP	—	IEN3	IEN2	IEN1	IEN0
	H'FFF5	IENR2	—	—	IENB1	—	—	—	—	—
	H'FFF9	MSTCR1	—	—	MSTS3	MSTAD	MSTWD	—	MSTTV	—
	H'FFFA	MSTCR2	MSTS3_2	—	—	MSTTB1	—	—	MSTTZ	MSTPWM
	H'FFFB	—	—	—	—	—	—	—	—	—

(7) Warnings that Apply to H8/36049 Group Programming

- (a) The description given in the hardware manual is “Initial value: 0. Reserved. These bits are always read as 0”. However, the description in the emulator manual is “Always specify 0. These bits are always read as the specified values”.

Table 8.39 Differences between the H8/36049 Group Products (1)

Target Address	Register Name	Bits
H'FFF2	Port mode register 3	7, 6, and 5
H'FFF5	Interrupt enable register 2	7 and 6
H'FFF9	Module standby control register 1	7
H'FFFA	Module standby control register 2	6, 5, and 3

- (b) The description given in the hardware manual is “Reserved”. However, the description in the emulator manual is “Always specify 0. These bits are always read as the specified values”.

Table 8.40 Differences between the H8/36049 Group Products (2)

Target Address	Register Name	Bits
H'FFFB	—	0

- (c) The hardware manual shows registers at the addresses given below. For these locations, however, the applicable description in the emulator manual is “Writing has no effect. These bits are always read as undefined values”, because there are no registers at these locations of the emulator.

Table 8.41 Differences between the H8/36049 Group Products (3)

Target Address	Register Name	Bits
H'F730	Low-voltage-detection control register	7 to 0
H'F731	Low-voltage-detection status register	7 to 0

- (d) The H8/36049 group has power-on reset and optional low-voltage detection circuit functions. However, the E6000 emulator does not support these functions.
- (e) While emulating the H8/36049 group, set PCR9 to '0' if you want to use SCI3_3.

- (f) While emulating the H8/36049 group, note that the register specifications at address H'F608 in the actual device and expansion I/O board (HS36024EIO61H) are different. Table 8.41 lists the specifications and note on them.

Table 8.42 Register Specifications and Note

Item	Register Specifications	Note
HS36024EIO61H	Bits 4 to 7 (1111): Reserved Bit 3 (0): Selects the device (1: H8/36049) Bit 2 (0): Selects whether or not to delete noise (0: no, 1: yes) Bit 1 (0): Selects the TXD3 output (0: port, 1: TXD_3) Bit 0 (0): Selects whether or not to stop modules (0: operate, 1: stop)	None
H8/36049	Bits 4 to 7 (1111): Reserved Bit 3 (1):Reserved (always read as 1 and writing has no effect) Bit 2 (0): Selects whether or not to delete noise (0: no, 1: yes) Bit 1 (0): Selects the TXD3 output (0: port, 1: TXD_3) Bit 0 (0): Selects whether or not to stop modules (0: operate, 1: stop)	For emulation with the expansion I/O board (HS36024EIO61H), set bits 3 to '1'.

Note: The value in parentheses indicates the initial value after a reset.

Table 8.43 Differences between the Evaluation Chip and the H8/36049 Registers

	Address	Register	Bit 7	Bit 6	Bit 5	Bit 4	Bit 3	Bit 2	Bit 1	Bit 0
H8/3660 (Evaluation chip)	H'F730	—	—	—	—	—	—	—	—	—
	H'F731	—	—	—	—	—	—	—	—	—
	H'FFE0	PMR1	IRQ3	IRQ2	IRQ1	IRQ0	TXD2	PWM	TXD	TMOW
	H'FFE1	PMR5	POF57	POF56	WKP5	WKP4	WKP3	WKP2	WKP1	WKP0
	H'FFE2	PMR3	POF27	POF26	POF25	POF24	POF23	—	—	—
	H'FFF1	SYSCR2	SMSSEL	LSON	DTON	MA2	MA1	MA0	SA1	SA0
	H'FFF2	IEGR1	NMIEG	—	—	—	IEG3	IEG2	IEG1	IEG0
	H'FFF4	IENR1	IENDT	IENTA	IENWP	—	IEN3	IEN2	IEN1	IEN0
	H'FFF5	IENR2	IENB3	IENB2	IENB1	—	—	—	—	—
	H'FFF9	MSTCR1	MSTS4	MSTIIC	MSTS3	MSTAD	MSTWD	MSTTW	MSTTV	MSTTA
	H'FFFA	MSTCR2	MSTS3_2	MSTTB3	MSTTB2	MSTTB1	MSTTX	—	MSTTZ0	MSTPWM
	H'FFFB	MSTCR3	—	—	—	—	—	—	—	MSTS4_2

	Address	Register	Bit 7	Bit 6	Bit 5	Bit 4	Bit 3	Bit 2	Bit 1	Bit 0
H8/36049	H'F730	LVDCR	LVDE	—	—	—	LVDSEL	LVDR	LVDD	LVDE
	H'F731	LVDSR	—	—	—	—	—	—	LVDDF	LVDDF
	H'FFE0	PMR1	IRQ3	IRQ2	IRQ1	IRQ0	TXD2	PWM	TXD	TMOW
	H'FFE1	PMR5	POF57	POF56	WKP5	WKP4	WKP3	WKP2	WKP1	WKP0
	H'FFE2	PMR3	—	—	—	POF24	POF23	—	—	—
	H'FFF1	SYSCR2	SMSSEL	LSON	DTON	MA2	MA1	MA0	SA1	SA0
	H'FFF2	IEGR1	NMIEG	—	—	—	IEG3	IEG2	IEG1	IEG0
	H'FFF4	IENR1	IENDT	IENTA	IENWP	—	IEN3	IEN2	IEN1	IEN0
	H'FFF5	IENR2	—	—	IENB1	—	—	—	—	—
	H'FFF9	MSTCR1	—	MSTIIC	MSTS3	MSTAD	MSTWD	MSTTW	MSTTV	MSTTA
	H'FFFA	MSTCR2	MSTS3_2	—	—	MSTTB1	—	—	MSTTZ	MSTPWM
	H'FFFB	—	—	—	—	—	—	—	—	—

(8) Warnings that Apply to H8/36109 Group Programming

- (a) The description given in the hardware manual is “Initial value: 0. Reserved. These bits are always read as 0”. However, the description in the emulator manual is “Always specify 0. These bits are always read as the specified values”.

Table 8.44 Differences between the H8/36109 Group Products (1)

Target Address	Register Name	Bits
H'FFF5	Interrupt enable register 2	7 and 6
H'FFF9	Module standby control register 1	7, 4, and 2
H'FFFA	Module standby control register 2	6, 5, 3, and 1

- (b) The description given in the hardware manual is “Reserved”. However, the description in the emulator manual is “Always specify 0. These bits are always read as the specified values”.

Table 8.45 Differences between the H8/36109 Group Products (2)

Target Address	Register Name	Bits
H'FFFB	—	0

- (c) The hardware manual shows registers at the addresses given below. For these locations, however, the applicable description in the emulator manual is “Writing has no effect. These bits are always read as undefined values”, because there are no registers at these locations of the emulator.

Table 8.46 Differences between the H8/36109 Group Products (3)

Target Address	Register Name	Bits
H'F730	Low-voltage-detection control register	7 to 0
H'F731	Low-voltage-detection status register	7 to 0
H'F734	Clock control/status register	7 to 0
H'F738	RC control register	7 to 0
H'F739	RC trimming data protect register	7 to 0
H'F73A	RC trimming data register	7 to 0
H'F73C	Interrupt control registers A	7 to 0
H'F73D	Interrupt control registers B	7 to 0
H'F73E	Interrupt control registers C	7 to 0
H'F73F	Interrupt control registers D	7 to 0
H'FF90	Flash memory control register 1	7 to 0
H'FF91	Flash memory control register 2	7 to 0
H'FF92	Flash memory power control register	7 to 0
H'FF93	Erase block register 1	7 to 0
H'FF9B	Flash memory enable register	7 to 0
H'FFEF	System control register 3	7 to 0

- (d) The H8/36109 group has power-on reset and optional low-voltage detection circuit functions. However, the E6000 emulator does not support these functions.
- (e) The product chip incorporates an on-chip oscillator. However, since the E6000 emulator does not incorporate this function, software debugging on the on-chip oscillator and the general input/output function of port J cannot be performed in the emulator.

Table 8.47 Differences between the Evaluation Chip and the H8/36109 Registers

	Address	Register	Bit 7	Bit 6	Bit 5	Bit 4	Bit 3	Bit 2	Bit 1	Bit 0
H8/3660 (Evaluation chip)	H'F730	—	—	—	—	—	—	—	—	—
	H'F731	—	—	—	—	—	—	—	—	—
	H'F734	—	—	—	—	—	—	—	—	—
	H'F738	—	—	—	—	—	—	—	—	—
	H'F739	—	—	—	—	—	—	—	—	—
	H'F73A	—	—	—	—	—	—	—	—	—
	H'F73C	—	—	—	—	—	—	—	—	—
	H'F73D	—	—	—	—	—	—	—	—	—
	H'F73E	—	—	—	—	—	—	—	—	—
	H'F73F	—	—	—	—	—	—	—	—	—
	H'FFEE	PCRC	PCRC7	PCRC6	PCRC5	PCRC4	PCRC3	PCRC2	PCRC1	PCRC0
	H'FFEF	—	—	—	—	—	—	—	—	—
	H'FFF5	IENR2	IENB3	IENB2	IENB1	—	—	—	—	—
	H'FFF7	IRR2	IRRTB3	IENB2	IENB1	—	—	—	—	—
	H'FFF9	MSTCR1	MSTS4	MSTIIC	MSTS3	MSTAD	MSTWD	MSTTW	MSTTV	MSTTA
H'FFFA	MSTCR2	MSTS3_2	MSTTB3	MSTTB2	MSTTB1	MSTTX	—	MSTTZ	MSTPWM	
H'FFFB	MSTCR3	—	—	—	—	—	—	—	MSTS4_2	
H'FFFC	TSCR	—	—	—	—	—	—	IICRST	IICX	

	Address	Register	Bit 7	Bit 6	Bit 5	Bit 4	Bit 3	Bit 2	Bit 1	Bit 0
H8/36109	H'F730	LVDCR	LVDE	BGRE	—	—	LVDSEL	LVDTRE	LVDDDE	LVDDUE
	H'F731	LVDSR	—	—	—	—	—	—	LVDDDF	LVDDUF
	H'F734	CKCSR	PMRJ1	PMRJ0	—	OSCSSEL	CKSWIE	CKSWIF	—	CKCSTA
	H'F738	RCCR	RCSTP	FSEL	VCLSEL	—	—	—	RCPSC1	RCPSC0
	H'F739	RCTRM DPR	WRI	PRWE	LOCKDW	TRMDRWE	—	—	—	—
	H'F73A	RCTRMDR	TRMD7	TRMD6	TRMD5	TRMD4	TRMD3	TRMD2	TRMD1	TRMD0
	H'F73C	ICRA	ICRA7	ICRA6	ICRA5	ICRA4	ICRA3	ICRA2	ICRA1	ICRA0
	H'F73D	ICRB	—	ICRB6	ICRB5	ICRB4	—	—	—	—
	H'F73E	ICRC	ICRC7	—	—	ICRC4	—	ICRC2	ICRC1	ICRC0
	H'F73F	ICRD	ICRD7	ICRD6	ICRD5	ICRD4	ICRD3	—	—	—
	H'FFEE	PCRC	—	—	—	—	PCRC3	PCRC2	PCRC1	PCRC0
	H'FFEF	SYSOCR3	STS3	—	—	—	—	—	—	—
	H'FFF5	IENR2	—	—	IENB1	—	—	—	—	—
	H'FFF7	IRR2	—	—	IENB1	—	—	—	—	—
	H'FFF9	MSTCR1	—	MSTIIC	MSTS3	—	MSTWD	—	MSTTV	MSTTA
	H'FFFA	MSTCR2	MSTS3_2	—	—	MSTTB1	—	—	—	MSTPWM
	H'FFFB	—	—	—	—	—	—	—	—	—
	H'FFFC	—	—	—	—	—	—	—	—	—

(9) Warnings that Apply to H8/36902, H8/36912 Group Programming

- (a) The description given in the hardware manual is “Initial value: 0. Reserved. These bits are always read as 0”. However, the description in the emulator manual is “Always specify 0. These bits are always read as the specified values”.

Table 8.48 Differences between the H8/36902, H8/36912 Group Products (1)

Target Address	Register Name	Bits
H'FFE0	Port mode register 1	6, 5, 3, 2, and 0
H'FFE1	Port mode register 5	7, 6, 4 to 0
H'FFF1	System control register 2	6, 1, and 0
H'FFF2	Interrupt edge select register 1	7, 2, and 1
H'FFF3	Interrupt edge select register 2	4 to 0
H'FFF4	Interrupt enable register 1	6, 2, and 1
H'FFF5	Interrupt enable register 2	7 and 6
H'FFF9	Module standby control register 1	7 and 0
H'FFFA	Module standby control register 2	7 to 5, 3 to 0

- (b) The hardware manual shows registers at the addresses given below. For these locations, however, the applicable description in the emulator manual is “Writing has no effect. These bits are always read as undefined values”, because there are no registers at these locations of the emulator.

Table 8.49 Differences between the H8/36902, H8/36912 Group Products (2)

Target Address	Register Name	Bits
H'F730	Low-voltage-detection control register	7 to 0
H'F731	Low-voltage-detection status register	7 to 0
H'F734	Clock control/status register	7 to 0
H'F735	RC control register	7 to 0
H'F736	RC trimming data protect register	7 to 0
H'F737	RC trimming data register	7 to 0
H'FFAE	Sampling mode register	7 to 0

- (c) The H8/36902, H8/36912 group has power-on reset, low-voltage detection, on-chip oscillator and noise filter of SCI. However, the E6000 emulator does not support these functions.
- (d) The initial value of WDON bit of Timer control/status register in H8/36902, H8/36912 group, is '1' in the hardware manual. When using E6000, however, the initial value is '0', and thus, please write '1' when you count up the watch dog timer.

Table 8.50 Differences between the H8/36902, H8/36912 Group Products (3)

Target Address	Register Name	Bits
H'FFC0	Timer control/status register	2

Table 8.51 Differences between the Evaluation Chip and the H8/36902, H8/36912 Registers

	Address	Register	Bit 7	Bit 6	Bit 5	Bit 4	Bit 3	Bit 2	Bit 1	Bit 0
H8/3660 (Evaluation chip)	H'F730	—	—	—	—	—	—	—	—	—
	H'F731	—	—	—	—	—	—	—	—	—
	H'F734	—	—	—	—	—	—	—	—	—
	H'F735	—	—	—	—	—	—	—	—	—
	H'F736	—	—	—	—	—	—	—	—	—
	H'F737	—	—	—	—	—	—	—	—	—
	H'FF90	—	—	—	—	—	—	—	—	—
	H'FF91	—	—	—	—	—	—	—	—	—
	H'FF93	—	—	—	—	—	—	—	—	—
	H'FF9B	—	—	—	—	—	—	—	—	—
	H'FFAE	—	—	—	—	—	—	—	—	—
	H'FFE0	PMR1	IRQ3	IRQ2	IRQ1	IRQ0	TXD2	PWM	TXD	TMOW
	H'FFE1	PMR5	POF57	POF56	WKP5	WKP4	WKP3	WKP2	WKP1	WKP0
	H'FFF1	SYSCR2	SMSSEL	LSON	DTON	MA2	MA1	MA0	SA1	SA0
	H'FFF2	IEGR1	NMIEG	—	—	—	IEG3	IEG2	IEG1	IEG0
	H'FFF3	IEGR2	—	—	WPEG5	WPEG4	WPEG3	WPEG2	WPEG1	WPEG0
	H'FFF4	IENR1	IENDT	IENTA	IENWP	—	IEN3	IEN2	IEN1	IEN0
	H'FFF5	IENR2	IENTB3	IENTB2	IENTB1	—	—	—	—	—
	H'FFF9	MSTCR1	MSTS4	MSTIIC	MSTS3	MSTAD	MSTWD	MSTTW	MSTTV	MSTTA
	H'FFFA	MSTCR2	MSTS3_2	MSTTB3	MSTTB2	MSTTB1	MSTTX	—	MSTTZ	MSTPWM

Table 8.51 Differences between the Evaluation Chip and the H8/36902, H8/36912 Registers(cont)

	Address	Register	Bit 7	Bit 6	Bit 5	Bit 4	Bit 3	Bit 2	Bit 1	Bit 0
H8/36902 H8/36912	H'F730	LVDCR	LVDE	BGRE	VDDII	—	LVDSSEL	LVDRE	LVDEE	LVDUE
	H'F731	LVDSR	—	—	—	—	—	—	LVDDF	LVDUF
	H'F734	CKCSR	PMRC1	PMRC0	—	OSCSSEL	CKSWIE	CKSWIF	—	CKSTA
	H'F735	RCCR	RCSTP	FSEL	VCLSEL	—	—	—	RCPSC1	RCPSC0
	H'F736	RCTRM DPR	WRI	PRWE	LOCKDW	TRMDRWE	—	—	—	—
	H'F737	RCTRMDR	TRMD7	TRMD6	TRMD5	TRMD4	TRMD3	TRMD2	TRMD1	TRMD0
	H'FF90	FLMCR1	—	SWE	ESU	PSU	EV	PV	E	P
	H'FF91	FLMCR2	FLER	—	—	—	—	—	—	—
	H'FF93	EBR1	—	—	EB5	EB4	EB3	EB2	EB1	EB0
	H'FF9B	FENR	FLSHE	—	—	—	—	—	—	—
	H'FFAE	SPMR	—	—	—	—	—	STDSPM	—	—
	H'FFE0	PMR1	IRQ3	—	—	IRQ0	—	—	TXD	—
	H'FFE1	PMR5	—	—	WKP5	—	—	—	—	—
	H'FFF1	SYSCR2	SMSSEL	—	DTON	MA2	MA1	MA0	—	—
	H'FFF2	IEGR1	—	—	—	—	IEG3	—	—	IEG0
	H'FFF3	IEGR2	—	—	WPEG5	—	—	—	—	—
	H'FFF4	IENR1	IENDT	—	IENWP	—	IEN3	—	—	IEN0
	H'FFF5	IENR2	—	—	IEN TB1	—	—	—	—	—
	H'FFF9	MSTCR1	—	MSTIIC	MSTS3	MSTAD	MSTWD	MSTTW	MSTTV	—
	H'FFFA	MSTCR2	—	—	—	MSTTB1	—	—	—	—

(10) Warnings that Apply to H8/36064 Group Programming

- (a) The description given in the hardware manual is “Initial value: 0. Reserved. These bits are always read as 0”. However, the description in the emulator manual is “Always specify 0. These bits are always read as the specified values”.

Table 8.52 Differences between the H8/36064 Group Products (1)

Target Address	Register Name	Bits
H'FFE0	Port mode register 1	0
H'FFE1	Port mode register 5	7 and 6
H'FFE2	Port mode register 3	7, 6, and 5
H'FFF1	System control register 2	6
H'FFF4	Interrupt enable register 1	6
H'FFF5	Interrupt enable register 2	7 and 6
H'FFF9	Module standby control register 1	7, 2, and 0
H'FFFA	Module standby control register 2	6, 5, and 3

- (b) The description given in the hardware manual is “Reserved”. However, the description in the emulator manual is “Always specify 0. These bits are always read as the specified values”.

Table 8.53 Differences between the H8/36064 Group Products (2)

Target Address	Register Name	Bits
H'FFFB	Module Standby Control Register 3	0

- (c) The hardware manual shows registers at the addresses given below. For these locations, however, the applicable description in the emulator manual is “Writing has no effect. These bits are always read as undefined values”, because there are no registers at these locations of the emulator.

Table 8.54 Differences between the H8/36064 Group Products (3)

Target Address	Register Name	Bits
H'F730	Low-voltage-detection control register	7 to 0
H'F731	Low-voltage-detection status register	7 to 0
H'FF90	Flash memory control register 1	7 to 0
H'FF91	Flash memory control register 2	7 to 0
H'FF92	Flash memory power control register	7 to 0
H'FF93	Erase block register 1	7 to 0
H'FF9B	Flash memory enable register	7 to 0

- (d) Although the hardware manual says that an initial value is 1, the compact emulator’s initial value is “0”. These bits must always be set to 1, when counting up the watchdog timer.

Table 8.55 Differences between the H8/36064 Group Products (4)

Target Address	Register Name	Bits
H'FFC0	Timer Control/Status Register WD	2

- (e) Although the hardware manual says that the allowable output high current is 5.0 mA, it is 2.0 mA in the E6000 emulator.

Table 8.56 Differences between the Evaluation Chip and the H8/36064 Registers

	Address	Register	Bit 7	Bit 6	Bit 5	Bit 4	Bit 3	Bit 2	Bit 1	Bit 0
H8/3660 (Evaluation chip)	H'F730	—	—	—	—	—	—	—	—	—
	H'F731	—	—	—	—	—	—	—	—	—
	H'FFE0	PMR1	IRQ3	IRQ2	IRQ1	IRQ0	TXD2	PWM	TXD	TMOW
	H'FFE1	PMR5	POF57	POF56	WKP5	WKP4	WKP3	WKP2	WKP1	WKP0
	H'FFE2	PMR3	POF27	POF26	POF25	POF24	POF23	—	—	—
	H'FFE4	PCR1	PCR17	PCR16	PCR15	PCR14	PCR13	PCR12	PCR11	PCR10
	H'FFE5	PCR2	PCR27	PCR26	PCR25	PCR24	PCR23	PCR22	PCR21	PCR20
	H'FFEA	PCR7	PCR77	PCR76	PCR75	PCR74	PCR73	PCR72	PCR71	PCR70
	H'FFEB	PCR8	PCR87	PCR86	PCR85	PCR84	PCR83	PCR82	PCR81	PCR80
	H'FFF0	SYSCR1	SSBY	STS2	STS1	STS0	NESEL	—	—	—
	H'FFF1	SYSCR2	SMSSEL	LSON	DTON	MA2	MA1	MA0	SA1	SA0
	H'FFF4	IENR1	IENDT	IENTA	IENWP	—	IEN3	IEN2	IEN1	IEN0
	H'FFF5	IENR2	IENTB3	IENTB2	IENTB1	—	—	—	—	—
	H'FFF6	IRR1	IRRDT	IRRTA	—	—	IRRI3	IRRI2	IRRI1	IRRI0
	H'FFF7	IRR2	IRRTB3	IENB2	IENB1	—	—	—	—	—
	H'FFF9	MSTCR1	MSTS4	MSTIIC	MSTS3	MSTAD	MSTWD	MSTTW	MSTTV	MSTTA
H'FFFA	MSTCR2	MSTS3_2	MSTTB3	MSTTB2	MSTTB1	MSTTX	—	MSTTZ	MSTPWM	
H'FFFB	MSTCR3	—	—	—	—	—	—	—	MSTS4_2	

	Address	Register	Bit 7	Bit 6	Bit 5	Bit 4	Bit 3	Bit 2	Bit 1	Bit 0
H8/36064	H'F730	LVDCR	LVDE	—	—	—	LVDSEL	LVDPRE	LVDDDE	LVDDUE
	H'F731	LVDSR	—	—	—	—	—	LVDDF	LVDDUF	—
	H'FFE0	PMR1	IRQ3	IRQ2	IRQ1	IRQ0	TXD2	PWM	TXD	TMOW
	H'FFE1	PMR5	—	—	WKP5	WKP4	WKP3	WKP2	WKP1	WKP0
	H'FFE2	PMR3	—	—	—	POF24	POF23	—	—	—
	H'FFE4	PCR1	PCR17	PCR16	PCR15	PCR14	—	PCR12	PCR11	PCR10
	H'FFE5	PCR2	—	—	—	PCR24	PCR23	PCR22	PCR21	PCR20
	H'FFEA	PCR7	—	PCR76	PCR75	PCR74	—	PCR72	PCR71	PCR70
	H'FFEB	PCR8	PCR87	PCR86	PCR85	—	—	—	—	—
	H'FFF0	SYSCR1	SSBY	STS2	STS1	STS0	—	—	—	—
	H'FFF1	SYSCR2	SMSSEL	—	DTON	MA2	MA1	MA0	—	—
	H'FFF4	IENR1	IENDT	—	IENWP	—	IEN3	IEN2	IEN1	IEN0
	H'FFF5	IENR2	—	—	IENB1	—	—	—	—	—
	H'FFF6	IRR1	IRRDT	—	—	—	IRRI3	IRRI2	IRRI1	IRRI0
	H'FFF7	IRR2	—	—	IENB1	—	—	—	—	—
	H'FFF9	MSTCR1	—	MSTIIC	MSTS3	MSTAD	MSTWD	—	MSTTV	—
H'FFFA	MSTCR2	MSTS3_2	—	—	MSTTB1	—	—	MSTTZ	MSTPWM	
H'FFFB	MSTCR3	—	—	—	—	—	—	—	—	

(11) Warnings that Apply to H8/36094 Group Programming

- (a) The description given in the hardware manual is “Initial value: 1. Reserved. These bits are always read as 1, and cannot be modified”. However, the description in the emulator manual is “Always specify 0. These bits are always read as the specified values”.

Table 8.57 Differences between the H8/36094 Group Products (1)

Target Address	Register Name	Bits
H'FFE0	Port mode register 1	3 and 2

- (b) The description given in the hardware manual is “Initial value: 0. Reserved. These bits are always read as 0, and cannot be modified”. However, the description in the emulator manual is “Always specify 0. These bits are always read as the specified values”.

Table 8.58 Differences between the H8/36094 Group Products (2)

Target Address	Register Name	Bits
H'FFE1	Port mode register 5	7 and 6
H'FFF9	Module standby control register 1	7

- (c) The description given in the hardware manual is “Reserved”. However, the description in the emulator manual is “Always specify 0. These bits are always read as the specified values”.

Table 8.59 Differences between the H8/36094 Group Products (3)

Target Address	Register Name	Bits
H'FFE2	Port mode register 3	7 to 3
H'FFF5	Interrupt enable register 2	7 to 5
H'FFFA	Module standby control register 2	7 to 0
H'FFFB	Module standby control register 3	0

- (d) The hardware manual shows registers at the addresses given below. For these locations, however, the applicable description in the emulator manual is “Writing has no effect. These bits are always read as undefined values”, because there are no registers at these locations of the emulator.

Table 8.60 Differences between the H8/36094 Group Products (4)

Target Address	Register Name	Bits
H'F730	Low-voltage-detection control register	7 to 0
H'F731	Low-voltage-detection control register	7 to 0
H'F734	Clock control/status register	7 to 0
H'F735	RC control register	7 to 0
H'F736	RC trimming data protect register	7 to 0
H'F737	RC trimming data register	7 to 0

- (e) Although the hardware manual says that an initial value is 1, the compact emulator's initial value is "0".
These bits must always be set to 1, when counting up the watchdog timer.

Table 8.61 Differences between the H8/36094 Group Products (5)

Target Address	Register Name	Bits
H'FFC0	Timer Control/Status Register WD	2

- (f) The H8/36094 group has power-on reset, optional low-voltage detection circuit functions and on-chip oscillator. However, the E6000 emulator does not support these functions.
- (g) The H8/36094 group has port C. However, the E6000 emulator does not support these functions.

Table 8.62 Differences between the Evaluation Chip and the H8/36094 Registers

	Address	Register	Bit 7	Bit 6	Bit 5	Bit 4	Bit 3	Bit 2	Bit 1	Bit 0
H8/3660 (Evaluation chip)	H'F730	—	—	—	—	—	—	—	—	—
	H'F731	—	—	—	—	—	—	—	—	—
	H'F734	—	—	—	—	—	—	—	—	—
	H'F735	—	—	—	—	—	—	—	—	—
	H'F736	—	—	—	—	—	—	—	—	—
	H'F737	—	—	—	—	—	—	—	—	—
	H'FFE0	PMR1	IRQ3	IRQ2	IRQ1	IRQ0	TXD2	PWM	TXD	TMOW
	H'FFE1	PMR5	POF57	POF56	WKP5	WKP4	WKP3	WKP2	WKP1	WKP0
	H'FFE2	PMR3	POF27	POF26	POF25	POF24	POF23	—	—	—
	H'FFF1	SYSCR2	SMSSEL	LSON	DTON	MA2	MA1	MA0	SA1	SA0
	H'FFF2	IEGR1	NMIEG	—	—	—	IEG3	IEG2	IEG1	IEG0
	H'FFF4	IENR1	IENDT	IENTA	IENWP	—	IEN3	IEN2	IEN1	IEN0
	H'FFF5	IENR2	IENB3	IENB2	IENB1	—	—	—	—	—
	H'FFF9	MSTCR1	MSTS4	MSTIIC	MSTS3	MSTAD	MSTWD	MSTTW	MSTTV	MSTTA
	H'FFFA	MSTCR2	MSTS3_2	MSTTB3	MSTTB2	MSTTB1	MSTTX	—	MSTTZ0	MSTPWM
	H'FFFB	MSTCR3	—	—	—	—	—	—	—	MSTS4_2

	Address	Register	Bit 7	Bit 6	Bit 5	Bit 4	Bit 3	Bit 2	Bit 1	Bit 0
H8/3694	H'F730	LVDCR	LVDE	—	—	—	LVDSEL	LVDR	LVDDE	LVDUE
	H'F731	LVDSR	—	—	—	—	—	—	LVDDF	LVDUF
	H'F734	CKCSR	PMRC1	PMRC0	—	OSCSEL	CKSWIE	CKSWIF	—	CKSTA
	H'F735	RCCR	RCSTP	FSEL	VCLSEL	—	—	—	RCPSC1	RCPSC0
	H'F736	RCTRM DPR	WRI	PRWE	LOCKDW	TRMDRWE	—	—	—	—
	H'F737	RCTRM DR	TRMD7	TRMD6	TRMD5	TRMD4	TRMD3	TRMD2	TRMD1	TRMD0
	H'FFE0	PMR1	IRQ3	IRQ2	IRQ1	IRQ0	—	—	TXD	TMOW
	H'FFE1	PMR5	—	—	WKP5	WKP4	WKP3	WKP2	WKP1	WKP0
	H'FFE2	—	—	—	—	—	—	—	—	—
	H'FFF1	SYSCR2	SMSSEL	LSON	DTON	MA2	MA1	MA0	SA1	SA0
	H'FFF2	IEGR1	NMIEG	—	—	—	IEG3	IEG2	IEG1	IEG0
	H'FFF4	IENR1	IENDT	IENTA	IENWP	—	IEN3	IEN2	IEN1	IEN0
	H'FFF5	—	—	—	—	—	—	—	—	—
	H'FFF9	MSTCR1	—	MSTIIC	MSTS3	MSTAD	MSTWD	MSTTW	MSTTV	MSTTA
	H'FFFA	—	—	—	—	—	—	—	—	—
	H'FFFB	—	—	—	—	—	—	—	—	—

8.2.2 Notes on Mode Transitions

The MCU makes a transition to some other mode when interrupts occur. In the E6000 emulator, a break interrupt occurs with any of the following operations or actions. Therefore, break interrupts will occur even when no interrupt has been set up in the user program. This will lead to unexpected mode transition.

- Forcible breaks (When the Esc key is pressed or the STOP tool bar button is clicked)
- Software breaks
- Breaks specified by the event detection system
- STEP (Step In, Step Over, Step Out) execution
- When a program is executed by a Go command from the address of a Software break.

When emulation breaks in the emulator, the operating mode immediately before the break (Active mode or Subactive mode) and the cause of the break are displayed in the status bar and status window. The operating mode can be referred to by looking at the status bar.

Examples: ROM Write-Access Break (Active)
 User Break (Subactive)

8.2.3 Access to the Reserved Area

When accessing the reserved area, note the following:

If the reserved area is used, the operation in the actual MCU cannot be guaranteed. If the user program extends to the reserved area during debugging, select the MCU having the largest ROM capacity (for example, debug the H8/3663 program in the H8/3664 mode).

In the E6000 emulator, one evaluation chip emulates several types of MCU. Therefore the emulator has I/O registers other than those of the target MCU. Therefore, do not access unused addresses in the I/O register area. The values when such unused address areas are read from and written to cannot be guaranteed. Note that the address range H'F000 to H'F77F is used by the emulator system so do not access this area. Values are not guaranteed when addresses in this range are read or written to. An access error break will not occur.

8.2.4 Environment for Execution of the Tutorial Program

- (1) This tutorial program runs on the debugging platform H8/3664 E6000 emulator CPU 300H. Be sure to remove the expansion I/O board from the H8/3664 E6000 emulator before running the tutorial program.
- (2) To execute the tutorial program, specify "Tutorial.hws" stored in the following directory:
OS installation drive \Workspace\Tutorial\E6000\3664

The directory mentioned above cannot be specified depending on the version of the software. In such cases, specify the following directory instead.

High-performance Embedded Workshop installation destination directory
\Tools\Renesas\DebugComp\Platform\E6000\3664\Tutorial

8.2.5 Note on Emulation of the H8/36912 Group and H8/36902 Group

The ROM/RAM capacity for the H8/36911 of the H8/36912 group and the H8/36901 and H8/36900 of the H8/36902 group is different in the MCU and the emulator. When you create a user program, be careful of the ROM/RAM usage because the size of the ROM/RAM in the emulator is larger than that of the MCU. In the MCU, specifying an unused area (addresses) by a range channel of an event point allows the program to stop when an illegal access occurs. For how to set event points, refer to section 5.15.7, Setting Event Points.

Table 8.57 Differences on the ROM/RAM Capacity

Device Name	MCU		E6000 Emulator	
	ROM	RAM	ROM	RAM
H8/36911	4 kbytes	256 bytes	8 kbytes	512 bytes
H8/36901	4 kbytes	256 bytes	8 kbytes	512 bytes
H8/36900	2 kbytes	256 bytes	8 kbytes	512 bytes

Appendix A I/O File Format

High-performance Embedded Workshop formats the [IO] window based on information it finds in an I/O Register definition file. When you select a debugging platform, High-performance Embedded Workshop will look for a “<device>.IO” file corresponding to the selected device and load it if it exists. This file is a formatted text file that describes the I/O modules and the address and size of their registers. You can edit this file, with a text editor, to add support for memory mapped registers or peripherals you may have specific to your application (e.g. registers in an ASIC device mapped into the microcomputer's address space).

The following describes two formats of the “<device>.IO” file that supports or not the bit field.

A.1 File format (Bit Field Not Supported)

Each module name must be defined in the [Modules] definition section and the numbering of each module must be sequential. Each module corresponds to a register definition section and within the section each entry defines an I/O register.

The [BaseAddress] definition is for devices where the location of I/O registers moves in the address space depending on the CPU mode. In this case, the [BaseAddress] value is the base address of the I/O registers in one specific mode and the addresses used in the register definitions are the address locations of the registers in the same mode. When the I/O register file is actually used, the [BaseAddress] value is subtracted from the defined register address and the resultant offset added to the relevant base address for the selected mode.

The [Register] definition entry is entered in the format <name> = <address> [<size> [<absolute>]].

1. <name> register name to be displayed.
2. <address> address of the register.
3. <size> which may be B, W or L for byte, word, or longword (default is byte).
4. <absolute> which can be set to A if the register is at an absolute address. This is only relevant if the I/O area address range moves about on the CPU in different modes. In this case, if a register is defined as absolute the base address offset calculation is not performed and the specified address is used directly.

Comment lines are allowed and must start with a “;” character.

An example is shown below.

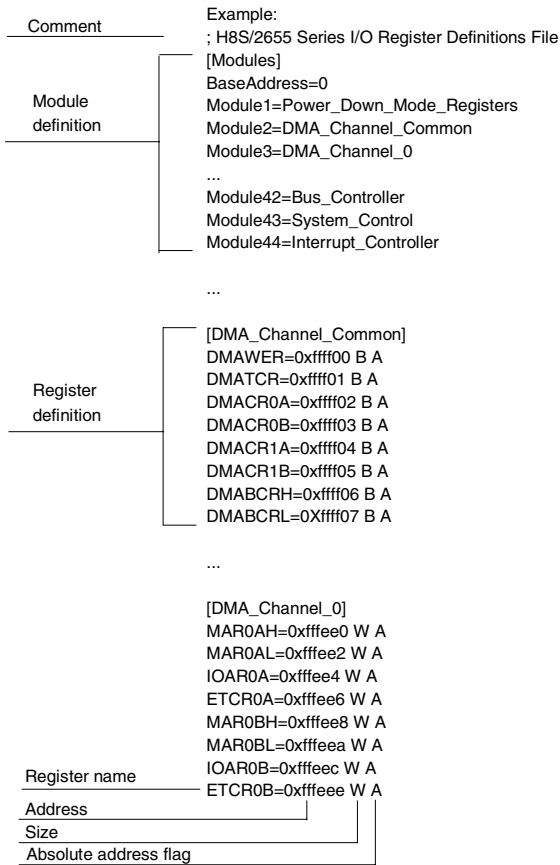

A.2 File format (Bit Field Supported)

Each module name must be defined in the [Modules] definition section and the numbering of each module must be sequential. Each module corresponds to a register definition section and within the section each entry defines an I/O register.

The user must define "FileVersion=2" at the start of the section. It means that this I/O register file is described with the version that supports the bit field.

The [BaseAddress] definition is for devices where the location of I/O registers moves in the address space depending on the CPU mode. In this case, the [BaseAddress] value is the base address of the I/O registers in one specific mode and the addresses used in the register definitions are the address locations of the registers in the same mode. When the I/O register file is actually used, the [BaseAddress] value is subtracted from the defined register address and the resultant offset added to the relevant base address for the selected mode.

Each module has a section that defines the registers forming it along with an optional dependency. The dependency is checked to see if the module is enabled or not. Each register name must be defined in the section and the numbering of each register must be sequential. The dependency is entered in the section as dep=<reg> <bit> <value>.

1. <reg> is the register id of the dependency.
2. <bit> is the bit position within the register.
3. <value> is the value that the bit must be for the module to be enabled.

The [Register] definition entry is entered in the format id=<name> <address> [<size> [<absolute>[<format>[<bitfields>]]]].

1. <name> register name to be displayed.
2. <address> address of the register.
3. <size> which may be B, W or L for byte, word, or longword (default is byte).
4. <absolute> which can be set to A if the register is at an absolute address. This is only relevant if the I/O area address range moves about on the CPU in different modes. In this case, if a register is defined as absolute the base address offset calculation is not performed and the specified address is used directly.
5. <format> format for register output. Valid values are H for Hexadecimal, D for decimal, and B for binary.
6. <bitfields> section defining the bits within the register.

Bitfield sections define the bits within a register each entry is of the type bit<no>=<name>.

1. <no> is the bit number.
2. <name> is a symbolic name of the bit.

Comment lines are allowed and must start with a ";" character.

An example is shown below.

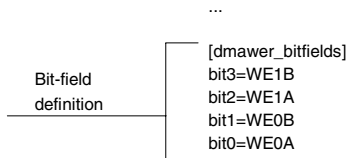
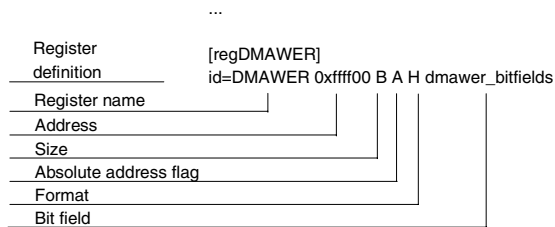
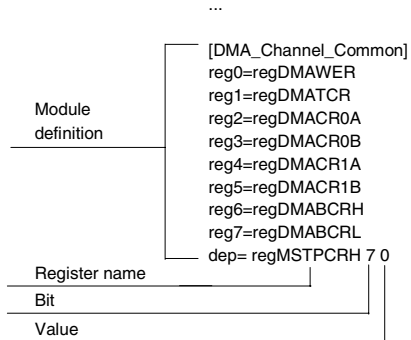
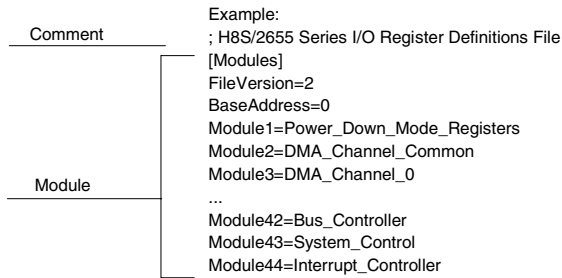

Appendix B Menus

Table B.1 shows GUI menus.

Table B.1 GUI Menus



















Menu	Option	Shortcut	Toolbar Button	Remarks	
View	Difference			Opens the [Difference] window.	
	Command Line	Ctrl + L		Opens the [Command Line] window.	
	TCL toolkit	Shift + Ctrl + L		Opens the [Console] window.	
	Workspace	Alt + K		Opens the [Workspace] window.	
	Output	Alt + U		Opens the [Output] window.	
	Disassembly	Ctrl + D		Opens the [Disassembly] window.	
	CPU	Registers	Ctrl + R		Opens the [Registers] window.
		Memory...	Ctrl + M		Opens the [Memory] window.
		IO	Ctrl + I		Opens the [IO] window.
		Status	Ctrl + U		Opens the [Status] window.
Extended Monitor				Opens the [Extended Monitor] window.	
Monitor		Monitor Setting...	Shift + Ctrl + E		Opens the [Monitor] window.
		Windows Select...			Opens the [Windows Select] dialog box to list, add, or edit the [Monitor] window.
	EEPROM...			Opens the [EEPROM] window.	
Symbol	Labels	Shift + Ctrl + A		Opens the [Labels] window.	
	Watch	Ctrl + W		Opens the [Watch] window.	
	Locals	Shift + Ctrl + W		Opens the [Locals] window.	
Code	Eventpoints	Ctrl + E		Opens the [Eventpoints] window.	
	Trace	Ctrl + T		Opens the [Trace] window.	
	Stack Trace	Ctrl + K		Opens the [Stack Trace] window.	

Table B.1 GUI Menus (cont)









Menu	Option	Shortcut	Toolbar Button	Remarks	
View (cont)	Graphic	Image...	Shift + Ctrl + G		Opens the [Image] window.
		Waveform...	Shift + Ctrl + V		Opens the [Waveform] window.
	Performance	Performance Analysis	Shift + Ctrl + P		Opens the [Performance Analysis] window.
Debug	Debug Sessions...				Opens the [Debug Sessions] dialog box to list, add, or remove the debug session.
	Debug Settings...				Opens the [Debug Settings] dialog box to set the debugging conditions or download modules.
	Reset CPU				Resets the target hardware and sets the PC to the reset vector address.
	Go		F5		Starts executing the user program at the current PC.
	Reset Go		Shift + F5		Resets the target hardware and executes the user program from the reset vector address.
	Go To Cursor				Starts executing the user program at the current PC until the PC reaches the address indicated by the current text cursor position.
	Set PC To Cursor				Sets the PC to the address at the row of the text cursor.
	Run...				Launches the [Run Program] dialog box allowing the user to enter the PC or PC breakpoint during executing the user program.
	Display PC		Shift + Ctrl + Y		Opens the Editor or Disassembly window at the address of the PC.

Table B.1 GUI Menus (cont)













Menu	Option	Shortcut	Toolbar Button	Remarks
Debug (cont)	Step In	F11		Executes a block of user program before breaking.
	Step Over	F10		Executes a block of user program before breaking. If a subroutine call is reached, then the subroutine will not be entered.
	Step Out	Shift + F11		Executes the user program to reach the end of the current function.
	Step...			Launches the [Step Program] dialog box allowing the user to modify the settings for stepping.
Step Mode	Auto			Steps only one source line when the [Source] window is active. When the [Disassembly] window is active, stepping is executed in a unit of assembly instructions.
	Assembly			Executes stepping in a unit of assembly instructions.
	Source			Steps only one source line.
Halt Program		Esc		Stops the execution of the user program.
Initialize				Disconnects the debugging platform and connects it again.
Connect				Connects the debugging platform.
Disconnect				Disconnects the debugging platform.
Save Memory...				Saves the specified memory area data to a file.
Verify Memory...				Verifies file contents against memory contents.
Configure Overlay...				Selects the target section group when the overlay function is used.
Download Modules				Downloads the object program.
Unload Modules				Unloads the object program.

Table B.1 GUI Menus (cont)

Menu	Option	Shortcut	Toolbar Button	Remarks	
Setup	Customize...			Customize the High-performance Embedded Workshop application.	
	Options...			Sets option of the High-performance Embedded Workshop application.	
	Format Views...			Configure fonts, colors, keywords and so on, for the window.	
	Radix	Hexadecimal			Uses a hexadecimal for displaying a radix in which the numerical values will be displayed and entered by default.
		Decimal			Uses a decimal for displaying a radix in which the numerical values will be displayed and entered by default.
		Octal			Uses an octal for displaying a radix in which the numerical values will be displayed and entered by default.
Binary				Uses a binary for displaying a radix in which the numerical values will be displayed and entered by default.	
Emulator	System...			Opens the [Configuration] dialog box allowing the user to modify the debugging platform settings.	
	Memory Resource...			Opens the [Memory Mapping] dialog box allowing the user to view and edit the debugging platform's current memory map.	

Appendix C Command Lines

Table C.1 lists the High-performance Embedded Workshop commands.

Table C.1 High-performance Embedded Workshop Commands

No.	Command Name	Abbreviation	Function
1	!	-	Comment
2	ADD_FILE	AF	Adds a file to the current project
3	ANALYSIS	AN	Enables or disables performance analysis
4	ANALYSIS_RANGE	AR	Sets or displays a performance analysis range
5	ANALYSIS_RANGE_DELETE	AD	Deletes a performance analysis range
6	AUTO_COMPLETE	AC	Enables or disables command complement function
7	ASSEMBLE	AS	Assembles instructions into memory
8	ASSERT	-	Checks if an expression is true or false
9	BREAKPOINT	BP	Sets a breakpoint at an instruction address
10	BREAKPOINT_CLEAR	BC	Deletes breakpoints
11	BREAKPOINT_DISPLAY	BD	Displays a list of breakpoints
12	BREAKPOINT_ENABLE	BE	Enables or disables a breakpoint
13	BREAKPOINT_SEQUENCE	BS	Sets sequential breakpoints
14	BUILD	BU	Starts a build operation on the current project
15	BUILD_ALL	BL	Starts a build all operation on the current project
16	CHANGE_CONFIGURATION	CC	Sets the current configuration
17	CHANGE_PROJECT	CP	Sets the current project
18	CHANGE_SESSION	CS	Changes the session of the current project
19	CLOCK	CK	Set the CPU clock rate in the emulator
20	CONFIGURE_PLATFORM	CPF	Sets the debugging environment for the emulator
21	CLOSE_WORKSPACE	CW	Close the current workspace
22	DEFAULT_OBJECT_FORMAT	DO	Sets the default object (program) format
23	DEVICE_TYPE	DE	Selects a device type to emulate
24	DISASSEMBLE	DA	Disassembles memory contents
25	EEPROM_COPY	EEPC	Transfers data between EEPROMs or EEPROM and normal memory
26	EEPROM_DISPLAY	EEPD	Displays the content of the EEPROM
27	EEPROM_EDIT	EEPE	Changes the content of the EEPROM
28	EEPROM_FILL	EEPF	Fills a block of the EEPROM with a specified value
29	EEPROM_SETMODE	EEPS	Selects the slave address of the EEPROM and the mode for writing data
30	ERASE	ER	Clears the [Command Line] window
31	EVALUATE	EV	Evaluates an expression
32	EXMONITOR_DISPLAY	EXMD	Displays the content of the expansion monitor
33	EXMONITOR_SET	EXMS	Selects whether or not to display the items in the expansion monitor

Table C.1 High-performance Embedded Workshop Commands (cont)

No.	Command Name	Abbreviation	Function
34	EXMONITOR_SETRATE	EXMSR	Sets the time to update the expansion monitor during emulation or a break
35	FILE_LOAD	FL	Loads an object (program) file
36	FILE_SAVE	FS	Saves memory to a file
37	FILE_UNLOAD	FU	Unloads a file
38	FILE_VERIFY	FV	Verifies file contents against memory
39	GENERATE_MAKE_FILE	GM	Creates a makefile to be built outside the High-performance Embedded Workshop
40	GO	GO	Executes user program
41	GO_RESET	GR	Executes user program from reset vector
42	GO_TILL	GT	Executes user program until temporary breakpoint
43	HALT	HA	Halts the user program
44	HELP	HE	Displays the syntax of a command
45	INITIALIZE	IN	Initializes the debugging platform
46	LOG	LO	Controls command output logging
47	MAP_DISPLAY	MA	Displays memory mapping
48	MAP_SET	MS	Sets memory mapping
49	MEMORY_COMPARE	MC	Compares memory contents
50	MEMORY_DISPLAY	MD	Displays memory contents
51	MEMORY_EDIT	ME	Modifies memory contents
52	MEMORY_FILL	MF	Modifies the content of a memory area by specifying data
53	MEMORY_FIND	MI	Searches for data within the memory range
54	MEMORY_MOVE	MV	Moves a block of memory
55	MEMORY_TEST	MT	Tests a block of memory
56	MODE	MO	Sets or displays the CPU mode
57	MODULES	MU	Sets up or displays the on-chip peripheral functions
58	MONITOR_CLEAR	MOC	Deletes a monitor point
59	MONITOR_DISPLAY	MOD	Displays the content of the monitor
60	MONITOR_REFRESH	MOR	Controls an automatic update of the content of the monitor
61	MONITOR_SET	MOS	Sets or displays a monitor point
62	OPEN_WORKSPACE	OW	Opens a workspace
63	QUIT	QU	Exits High-performance Embedded Workshop
64	RADIX	RA	Sets default input radix
65	REFRESH	RF	Updates windows related to memory
66	REGISTER_DISPLAY	RD	Displays CPU register values
67	REGISTER_SET	RS	Sets CPU register contents
68	REMOVE_FILE	REM	Deletes the specified file from the current project
69	RESET	RE	Resets CPU
70	SLEEP	-	Delays command execution
71	SAVE_SESSION	SE	Saves the session of the current project
72	STATUS	STS	The content of the [Platform] sheet in the [Status] window is displayed.

Table C.1 High-performance Embedded Workshop Commands (cont)

No.	Command Name	Abbreviation	Function
73	STEP	ST	Steps program (by instructions or source lines)
74	STEP_MODE	SM	Sets the step mode
75	STEP_OUT	SP	Steps out of the current function
76	STEP_OVER	SO	Steps program, not stepping into functions
77	STEP_RATE	SR	Sets or displays rate of stepping
78	SUBMIT	SU	Executes a command file
79	SYMBOL_ADD	SA	Defines a symbol
80	SYMBOL_CLEAR	SC	Deletes a symbol
81	SYMBOL_LOAD	SL	Loads a symbol information file
82	SYMBOL_SAVE	SS	Saves a symbol information file
83	SYMBOL_VIEW	SV	Displays symbols
84	SAVE_WORKSPACE	SW	Saves the current workspace
85	TCL	-	Enables or disables the TCL
86	TIMER	TI	Sets or displays the timer resolution
87	TOOL_INFORMATION	TO	The information on the tool registered is outputted by the file
88	TRACE	TR	Displays trace information
89	TRACE_ACQUISITION	TA	Sets or displays trace acquisition parameters
90	TRACE_BINARY_COMPARE	TBC	Compares a trace binary file with the current trace information
91	TRACE_BINARY_SAVE	TBV	Outputs trace information into a binary file
92	TRACE_FILTER	TF	Filter the trace information
93	TRACE_STATISTIC	TST	Analyzes statistic information
94	TRACE_SAVE	TV	Outputs trace information into a file
95	TRIGGER_CLEAR	TGC	Deletes the trigger output condition for EXT.2
96	TRIGGER_DISPLAY	TGD	Displays the trigger output condition for EXT.2
97	TRIGGER_SET	TGS	Sets the trigger output condition for EXT.2
98	UPDATE_ALL_DEPENDENCIES	UD	Updates the dependencies for the current project
99	USER_SIGNALS	US	Enables or disables the user signal information
100	WATCH_ADD	WA	Adds a watch item
101	WATCH_AUTO_UPDATE	WU	Selects or cancels automatic update of watch items
102	WATCH_DELETE	WD	Deletes a watch item
103	WATCH_DISPLAY	WI	Displays the contents of the Watch window
104	WATCH_EDIT	WE	Edits the value of a watch item
105	WATCH_EXPAND	WX	Expands or collapses a watch item
106	WATCH_RADIX	WR	Changes the radix of a watch item to be displayed
107	WATCH_SAVE	WS	Saves the contents of the Watch window to a file

For the syntax of each command, refer to the online help.

Appendix D Diagnostic Test Procedure

This section describes the diagnostic test procedure using the E6000 test program.

D.1 System Set-Up for Test Program Execution

To execute the test program, use the following hardware; do not connect the user system interface cable, user system, or expansion I/O board.

- E6000 emulator (HS3664EPI61H or HS3664EPI62H)
 - Host computer
 - The E6000 PC interface board (select either from the followings according to the PC interface specifications):
 - PCI bus interface board (HS6000EIC01H or HS6000EIC02H)
 - PCMCIA interface card (HS6000EIP01H)
 - LAN adapter (HS6000ELN01H)
 - USB adapter (HS6000EIU01H or HS6000EIU02H)
1. Install the E6000 PC interface board in the host computer and connect the supplied PC interface cable to the board.
 2. Connect the PC interface cable to the emulator.
 3. Connect the supplied AC adapter to the emulator.
 4. Initiate the host computer to make it enter DOS prompt command input wait state.
 5. Turn on the emulator power switch.

D.2 Diagnostic Test Procedure Using Test Program

The CD-R includes a test program for this emulator (HS3664EPI62H) and that for the previous version of the emulator (HS3664EPI61H) that does not incorporate the USB interface. Usually refer to the descriptions for the HS3664EPI62H below.

Insert the CD-R (HS3664EPI62SR supplied with the emulator) into the CD-ROM drive of the host computer and move the current directory to either of those listed below with a command prompt.

When HS3664EPI61H is in use: <Drive>:\Diag\HS3664EPI61H

When HS3664EPI62H is in use: <Drive>:\Diag\HS3664EPI62H

Then enter one of the following commands according to the PC interface board in use to initiate the test program:

1. PCI bus interface board (HS6000EIC01H or HS6000EIC02H)
When HS3664EPI61H is in use: > TM3664 -PCI (RET)
When HS3664EPI62H is in use: > TM3664_62 -PCI (RET)
2. PCMCIA interface card (HS6000EIP01H)
When HS3664EPI61H is in use: > TM3664 -PCCD (RET)
When HS3664EPI62H is in use: > TM3664_62 -PCCD (RET)
3. LAN adapter (HS6000ELN01H)
When HS3664EPI62H is in use: > TM3664_62 -ELN (RET)
4. USB adapter (when using the USB interface in the emulator)
When HS3664EPI62H is in use: > TM3664_62 -USB (RET)

Note: When HS3664EPI61H is in use, the test program is not supported for the LAN or USB adapter.

The High-performance Embedded Workshop must be installed before the test program is executed.

Be sure to initiate the test program from <Drive>:\Diag\HS3664EPI62H. Do not initiate it from a directory other than <Drive>:\Diag\HS3664EPI62H, such as > <Drive>:\Diag\HS3664EPI62H\TM3664_62 -PCI (RET). If the test program is initiated when the current directory is not <Drive>:\Diag\HS3664EPI62H, the test program will not operate correctly.

When -S is added to the command line such as >TM3664_62 -PCI -S (RET), steps 1 to 20 will be repeatedly executed. To stop the execution, enter Q.

- Notes:
1. <Drive> is a drive name for the CD-ROM drive.
 2. Do not remove the CD-R from the CD-ROM drive during test program execution.

The following messages are displayed during test. This test consists of steps 1 to 20. This example assumes that HS3664EPI62H is in use. Time required for this test depends on performance of the host computer and PC interface in use (approximately 2 to 10 minutes).

Message	Description
E6000 H8/3664 Emulator Tests Vx.x Copyright (c) 2001, 2003 Renesas Technology Corp.	Test program start message. Vx.x shows the version number.
Loading driverOK Initializing driverOK Searching for interface cardOK	Shows that the PC interface board is correctly installed in the host computer.
Checking emulator is connectedOK	Shows that the E6000 is correctly connected to the host computer.
Emulator Board Information:	
Main Board ID: H'05	Shows the ID number of the lower board of the E6000 (always 5).
Emulation Board ID: H'17	Shows the ID number of the upper board of the E6000 (always 17).
SUB board ID: H'f	Shows the ID number of the E6000 (expansion I/O board) as f.
Option memory board: None	Shows whether the SIMM memory board is installed.
01) Test Register:	Shows the check results for the registers in the E6000 (normal completion).
A) IDR0 RegisterOK B) PAGE RegisterOK C) TRACE G/A Register.....OK D) PERFM G/A Register.....OK E) CES G/A Register.....OK F) IDR1 Register.....OK G) IDR2 Register.....OK	
02) Test DPRAM :	Shows the results of decoding test and marching test for the dual-port RAM in the E6000 (normal completion).
A) Decode TestOK B) Marching TestOK	

03) Test Firmware RAM :		Shows the results of decoding test for the firmware RAM in the E6000 (normal completion).
A) Decode Test	page [H'700 - H'71f]OK	
B) Marching Test	page [H'700 - H'71f]OK	Shows the results of marching test for the firmware RAM in the E6000 (normal completion).
04) Test Trace memory :		Shows the results of decoding test for the trace RAM (first half) in the E6000 (normal completion).
A) Decode Test	page [H'000 - H'04f] (Lower 32K) ...OK	
B) Marching Test	page [H'000 - H'04f] (Lower 32K) ...OK	Shows the results of marching test for the trace RAM (first half) in the E6000 (normal completion).
C) Decode Test	page [H'000 - H'04f] (Upper 32K) ...OK	Shows the results of decoding test for the trace RAM (last half) in the E6000 (normal completion).
D) Marching Test	page [H'000 - H'04f] (Upper 32K) ...OK	Shows the results of marching test for the trace RAM (last half) in the E6000 (normal completion).
05) RESERVED		
06) Test Internal ROM and RAM :		Shows the results of decoding test and marching test for internal ROM and RAM in the E6000 (normal completion).
A) Decode Test (Internal ROM)OK	
B) Marching Test (Internal ROM)	...OK	
C) Decode Test (Internal RAM)OK	
D) Marching Test (Internal RAM)	...OK	
07) RESERVED		
08) Test Emulation RAM STEP Operation :		Shows the check results for the step execution controlling circuits in the E6000 (normal completion).
A) Step OperationOK	
09) Test Keybreak :		Shows the check results for the forced break controlling circuits in the E6000 (normal completion).
A) Key BreakOK	
10) Test Emulation RAM Hardware Break :		Shows the check results for the illegal access break controlling circuits in the E6000 (normal completion).
A) GRD BreakOK	
B) WPT BreakRESERVED	
C) WPT (ROM) BreakRESERVED	

- | | |
|---|---|
| <p>11) Test Internal ROM Write Protect :</p> <p>A) Write ProtectOK</p> <p>B) Write Not ProtectOK</p> | <p>Shows the check results for the internal ROM write-protection controlling circuits in the E6000 (normal completion).</p> |
| <p>12) Test Hardware Break :</p> <p>A) Break Point InitializedOK</p> <p>B) Event Detectors CES channel 1-12OK</p> <p>C) Test Sequencing 1OK</p> <p>D) Check Range BreakOK</p> <p>E) Range Break Test for DataOK</p> <p>F) Check Compare EitherOK</p> | <p>Shows the check results for the hardware break control circuits in the E6000 (normal completion).</p> |
| <p>13) Test Emulation RAM Trace :</p> <p>A) Free TraceOK</p> <p>B) Range TraceOK</p> <p>C) Point to Point TraceOK</p> <p>D) Start and Stop Event TraceOK</p> <p>E) Trace memory OverflowOK</p> <p>F) Time STAMP Trace.....OK</p> <p>G) ASEBKTOA/B_N TraceRESERVED</p> | <p>Shows the check results for the trace controlling circuits in the E6000 (normal completion).</p> |
| <p>14) Test Runtime Counter :</p> <p>A) Internal Clock 20MHzOK</p> <p>B) Internal Clock 16MHzOK</p> <p>C) Internal Clock 10MHzOK</p> <p>D) Internal Clock 1MHzOK</p> <p>E) Internal Sub Clock 32.768KHzOK</p> | <p>Shows the check results for the run-time counter in the E6000 (normal completion).</p> |
| <p>15) Test Emulation Monitor :</p> <p>A) EMA23-EMA0OK</p> <p>B) ACST2-ACST0OK</p> <p>C) AEST3-AEST0OK</p> <p>D) ASEBRKACK (MONITOE)OK</p> <p>E) CNNOK</p> <p>F) NOCLKOK</p> | <p>Shows the check results for the emulation monitor controlling circuits in the E6000 (normal completion).</p> |
| <p>16) Test PERFM G/A :</p> <p>A) Time MeasurementOK</p> <p>B) Point to Point Time MeasurementRESERVED</p> <p>C) Subroutine Count MeasurementOK</p> <p>D) Timeout Function (TIMOT Bit)OK</p> <p>E) Timeout Function (TIMOP Bit)OK</p> | <p>Shows the check results for analysis controlling circuits in the E6000 (normal completion).</p> |
| <p>17) Test Bus Monitor :</p> <p>A) RegisterOK</p> <p>B) Parallel RAMOK</p> <p>C) SPRSEL2OK</p> <p>D) RAM MonitorOK</p> | <p>Shows the check results for the bus monitor controlling circuits in the E6000 (normal completion).</p> |

18) Test Parallel Access :	Shows the check results for the parallel access controlling circuits in the E6000 (normal completion).
A) Internal ROM Parallel Read Access (WORD)OK	
B) Internal ROM Parallel Write Access (WORD)OK	
C) Internal ROM Parallel Write Access (High Byte)OK	
D) Internal ROM Parallel Write Access (Low Byte)OK	
E) Internal RAM Parallel Read Access (WORD)OK	
F) Internal RAM Parallel Write Access (WORD)OK	
G) Internal RAM Parallel Write Access (High Byte)OK	
H) Internal RAM Parallel Write Access (Low Byte)OK	
I) Option RAM Parallel Read Access (WORD)RESERVED	
J) Option RAM Parallel Write Access (WORD)RESERVED	
K) Option RAM Parallel Write Access (High Byte)RESERVED	
L) Option RAM Parallel Write Access (Low Byte)RESERVED	
19) Test Go Reset:	Shows the check results for the Go RESET controlling circuits in the E6000 (normal completion).
A) Go Reset.....OK	
B) Bus 00>FF.....OK	
20) Test Normal Mode:	Shows the check results for Normal Mode (normal completion).
A) Normal Mode TestOK	
B) Address 23:16=00 TestOK	
Tests run for xH:xM:xxS	Total testing time.
Tests passed, emulator functioning correctly	Shows that the E6000 is correctly operating.

**Renesas Microcomputer Development Environment System
User's Manual
H8/3664 E6000 Emulator**

Publication Date: Rev.6.00, February 5, 2007
Published by: Sales Strategic Planning Div.
Renesas Technology Corp.
Edited by: Customer Support Department
Global Strategic Communication Div.
Renesas Solutions Corp.

Renesas Technology Corp. Sales Strategic Planning Div. Nippon Bldg., 2-6-2, Ohte-machi, Chiyoda-ku, Tokyo 100-0004, Japan



RENESAS SALES OFFICES

<http://www.renesas.com>

Refer to "<http://www.renesas.com/en/network>" for the latest and detailed information.

Renesas Technology America, Inc.

450 Holger Way, San Jose, CA 95134-1368, U.S.A
Tel: <1> (408) 382-7500, Fax: <1> (408) 382-7501

Renesas Technology Europe Limited

Dukes Meadow, Millboard Road, Bourne End, Buckinghamshire, SL8 5FH, U.K.
Tel: <44> (1628) 585-100, Fax: <44> (1628) 585-900

Renesas Technology (Shanghai) Co., Ltd.

Unit 204, 205, AZIACenter, No.1233 Lujiazui Ring Rd, Pudong District, Shanghai, China 200120
Tel: <86> (21) 5877-1818, Fax: <86> (21) 6887-7898

Renesas Technology Hong Kong Ltd.

7th Floor, North Tower, World Finance Centre, Harbour City, 1 Canton Road, Tsimshatsui, Kowloon, Hong Kong
Tel: <852> 2265-6688, Fax: <852> 2730-6071

Renesas Technology Taiwan Co., Ltd.

10th Floor, No.99, Fushing North Road, Taipei, Taiwan
Tel: <886> (2) 2715-2888, Fax: <886> (2) 2713-2999

Renesas Technology Singapore Pte. Ltd.

1 Harbour Front Avenue, #06-10, Keppel Bay Tower, Singapore 098632
Tel: <65> 6213-0200, Fax: <65> 6278-8001

Renesas Technology Korea Co., Ltd.

Kukje Center Bldg. 18th Fl., 191, 2-ka, Hangang-ro, Yongsan-ku, Seoul 140-702, Korea
Tel: <82> (2) 796-3115, Fax: <82> (2) 796-2145

Renesas Technology Malaysia Sdn. Bhd

Unit 906, Block B, Menara Amcorp, Amcorp Trade Centre, No.18, Jalan Persiaran Barat, 46050 Petaling Jaya, Selangor Darul Ehsan, Malaysia
Tel: <603> 7955-9390, Fax: <603> 7955-9510

H8/3664 E6000 Emulator User's Manual



Renesas Technology Corp.

2-6-2, Ote-machi, Chiyoda-ku, Tokyo, 100-0004, Japan